

REMER
RUBINETTERIE

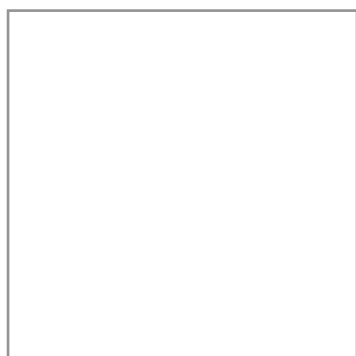

2021-22
COLLECTION

2021-22

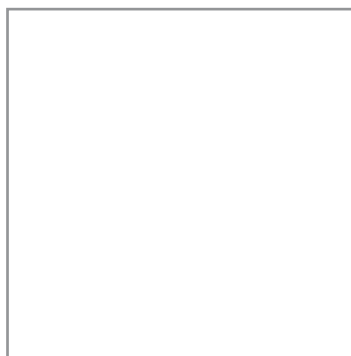

REMER

RUBINETTERIE

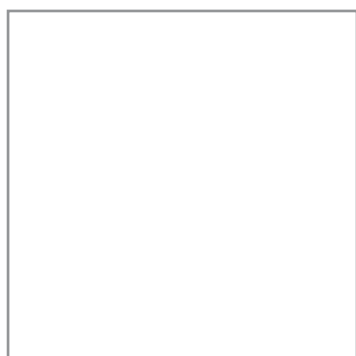

LISTINO PREZZI
PRICE LIST

ARREDARE IL BAGNO - FURNISHING THE BATHROOM

DESIGN



ABSOLUTE
PAG.22



ENERGY
PAG.34



VANITY
PAG.48



INFINITY
PAG.58



DREAM
PAG.70



CLASS LINE / ECO
PAG.80 / 92



WINNER / ECO
PAG.98 / 112

DESIGN MINIMALE - MINIMAL DESIGN



X STYLE
PAG.120



Q DESIGN
PAG.134



MINIMAL
PAG.144



QUBIKA
PAG.158



QUBIKA CASCATA
PAG.170

CONTRACT



TEN
PAG.178



GIGA FOUR
PAG.182



KISS
PAG.186



REMIX
PAG.194



35
PAG.200

CLASSICA - CLASSIC



LIBERTY
PAG.208



1000-2000
PAG.220

TERMOSTATICI - THERMOSTATICS



ELEGANCE
PAG.232



Q-ELEGANCE
PAG.244

SENSOR & TEMPOR



SENSOR
PAG.252



SENSOR COLOR
PAG.262



TEMPOR TOUCH
PAG.266



TEMPOR
PAG.270

ACCESSORI - ACCESSORIES



COMPLEMENTI
COMPLEMENTARY ITEMS
PAG.276



RICAMBI
SPARE PARTS
PAG.290

INOX DESIGN



X STYLE
INOX
PAG.304



WELLNESS INOX
INOX WELLNESS
PAG.308



ACCESSORI INOX
INOX ACCESSORIES
PAG.320



CUCINA INOX
INOX KITCHEN
PAG.324

WELLNESS



BOX INCASSO
BUILT-IN BOX
PAG.332



KIT WELLNESS
WELLNESS KIT
PAG.340



CROMOTERAPIA
COLOR THERAPY
PAG.356



SOFFIONI
SHOWER HEADS
PAG.368



BOCCH
SPOUTS
PAG.384



PANNELLI DOCCIA
SHOWER PANELS
PAG.390



COLONNE DOCCIA
SHOWER COLUMNS
PAG.394



SALISCENDI
SLIDING RAILS
PAG.424



DOCCETTE
HANSHOWERS
PAG.434



SHUT-OFF
PAG.444



BORDO VASCA
DECK BATH MIXERS
PAG.454



FLESSIBILI DOCCIA
SHOWER FLEXIBLES
PAG.458

ARREDARE LA CUCINA - FURNISHING THE KITCHEN



TOUCH-ME
PAG.468



COLOR
PAG.472



ACQUA DEPURATA
PURIFIED WATER
PAG.474

TECNOLOGIA IN CUCINA
TECHNOLOGY IN THE KITCHEN



ELEGANT GOURMET
PAG.482



GOURMET
PAG.488



ELEGANT KITCHEN
PAG.492



TUTTO CUCINA
ALL KITCHEN
PAG.498



CUCINA COUNTRY
COUNTRY KITCHEN
PAG.506



BORDO LAVELLO
DECK SINK MIXER
PAG.508

ELEGANZA IN CUCINA
ELEGANT KITCHEN

ACCESSORI BAGNO - BATH ACCESSORIES



LOUNGE
PAG.514



FLAT
PAG.516



GUEST
PAG.518



MINIMAL INOX
PAG.522



SQ
PAG.524



SUITE
PAG.526



900
PAG.528



EPOCA
PAG.532



ACCESSORI
ACCESSORIES
PAG.534



IDROSCOPINI
HYDRO-BRUSH
PAG.538



OPZIONI DI FINITURA FINISHING OPTIONS

FIN 1



NO nero opaco
matt black



BO bianco opaco
matt white



NP nichel spazzolato
brushed nickel



NPO nichel spazzolato opaco
matt brushed nickel

Crea uniche combinazioni di arredo personalizzando la rubinetteria con le opzioni di finitura. Un ventaglio di 8 colori che si inseriscono con facilità in ambienti sia classici che moderni per rispondere alle esigenze stilistiche dei progetti più creativi.

Verifica all'interno del catalogo quali opzioni di finitura sono state selezionate per ogni collezione di rubinetteria e scegli il colore perfetto per il tuo arredo!

Create unique furniture combinations by customizing the taps with finishing options. A range of 8 colors that easily fit into both classic and modern environments to meet the stylistic needs of the most creative projects.

Check in the catalog which finishing options have been selected for each faucet collection and choose the perfect color for your furniture!

FIN 2



CFP cromo nero spazzolato
brushed black chrome



BG oro spazzolato
brushed gold



DO oro lucido
shiny gold

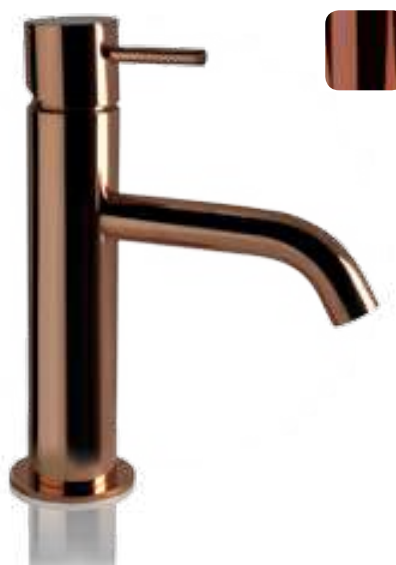

RL rame lucido
shiny copper



Serie X-STYLE proposta nella finitura:
rame lucido.
*X-STYLE series proposed in the finishes:
shiny copper.*



Serie ABSOLUTE proposta nelle finiture:
oro spazzolato, nichel spazzolato opaco.
*ABSOLUTE series proposed in the finishes:
brushed gold, matt brushed nickel.*





Serie INFINITY proposta nella finitura:
bianco opaco.
*INFINITY series proposed in the finishes:
matt white.*



Serie ENERGY proposta nella finitura:
nero opaco.
*ENERGY series proposed in the finishes:
matt black.*



Serie DREAM proposta nella finitura:
oro lucido.
*DREAM series proposed in the finishes:
shiny gold.*



Serie ENERGY proposta nella finitura:
nero opaco.
*ENERGY series proposed in the finishes:
matt black.*



Serie VANITY proposta nella finitura:
nichel spazzolato, oro spazzolato.
*VANITY series proposed in the finishes:
brushed nickel, brushed gold.*





Serie Q DESIGN proposta nella finitura:
bianco opaco.

*Q DESIGN series proposed in the finishes:
matt white.*



Serie CLASS LINE proposta nella finitura:
nichel spazzolato.

*CLASS LINE series proposed in the finishes:
brushed nickel*



REMER GROUP

**LAVORIAMO PER CONTINUARE A SUPERARCI
E PER OFFRIRVI SEMPRE NUOVE SOLUZIONI**

**WE WORK TO CONSTANTLY IMPROVE
AND TO ALWAYS OFFER YOU NEW SOLUTIONS**

Dal lontano 1965, anno di fondazione di Remer Rubinetterie, sono cambiate davvero molte cose. In questi 55 anni siamo cresciuti, ci siamo evoluti, ingranditi e automatizzati. Abbiamo corso, non tanto per restare al passo con i tempi, quanto per cercare sempre di anticiparli aggiungendo alla nostra offerta tutta l'innovazione necessaria a fare la differenza.

Abbiamo creato per noi e per voi con forte passione ed energia, tenendo vivo il grande amore per il nostro lavoro e dedicandovi il meglio di ogni nostro prodotto.

Un Gruppo, una Squadra, una grande Famiglia che ora conta circa 250 dipendenti e moltissimi collaboratori, tutti uniti da un'unica filosofia: dare il meglio, ogni giorno, in qualsiasi ruolo, perché uniti e guardando avanti siamo una forza unica.

Nel 55° ANNIVERSARIO, un RINGRAZIAMENTO SPECIALE da parte di tutto il gruppo REMER va come sempre ai nostri Partner commerciali che, da molti anni, credono in noi e crescono insieme a noi.

Questi decenni di collaborazione hanno costruito un affetto sincero che accompagna ed aggiunge valore ad ogni fase del nostro lavoro.

Continueremo ad essere al vostro fianco con un supporto costante in oltre 130 Nazioni, continueremo a stupirvi con nuove collezioni e a proporvi soluzioni innovative studiate su misura per le vostre attività.

Questo 55° ANNIVERSARIO è un piccolo grande traguardo ed è un nuovo punto di partenza per continuare a crescere INSIEME.

Grazie per la Vostra FIDUCIA.
La REMER SIAMO NOI!!!

Since the far 1965, the year of Remer Rubinetterie foundation, many things have changed. Over the past 55 years we have grown, we have evolved, enlarged and automated. We have run, not so much to keep up with the times, but always trying to lead them enough to add to our offer all the innovation necessary to make the difference.

We have created for us and for you with strong passion and energy, keeping alive the great love for our work and dedicating to you the best of each of our products.

A Group, a Team, a large Family that now has about 250 employees and many collaborators, all united by a single philosophy: to give the best, every day, in any role, because united and looking forward we are a unique force.

In the 55th ANNIVERSARY, a SPECIAL THANKS from all the REMER group goes as usual to our commercial Partners who, for many years, believe in us and grow with us.

These decades of collaboration have built a sincere affection that accompanies and adds value to every phase of our work.

We will continue to be at your side with constant support in over 130 countries, we will continue to amaze you with new collections and offer innovative solutions tailored to your activities.

This 55th ANNIVERSARY is a great little achievement and a new starting point for continuing to grow TOGETHER.

*Thank you for your trust.
REMER IS US!!!*



- Antonio Repici -



LA NOSTRA FORZA

OUR STRENGTH

PERCHÉ SIAMO UN PARTNER SPECIALE

WHAT MAKES US A SPECIAL PARTNER

- Dipartimento interno di Engineering e Design italiano.
- Produzione automatizzata e robotizzata.
- Produzione interna di articoli fusi, stampati, da barra e da tubo di ottone.
- Produzione interna di raccorderia.
- Produzione interna di componenti in plastica.
- Produzione interna di cartucce.
- Produzione interna di flessibili.
- Dipartimento interno per lo sviluppo e la produzione delle tecnologie
- Impianti interni per pulitura e lucidatura.
- Impianti interni per cromatura e verniciatura.
- Linee di assemblaggio automatiche.
- Circa 100 postazioni in radio frequenza.
- Test di qualità.
- Produzione interna degli imballi.
- Gestione interna della logistica.
- Supporto commerciale qualificato pre e post vendita.

- *Internal Department of Engineering and Italian Design.*
- *Automated and robotic production*
- *Internal production of casted and forged items, brass bar, plate and brass tube items.*
- *Internal production of fittings.*
- *Internal production of plastic components.*
- *Internal production of cartridges.*
- *Internal production of Flexible hoses.*
- *Internal Department for the development and the production of technologies*
- *Internal plants for cleaning and polishing.*
- *Internal plants for chrome plating and varnishing.*
- *Automatic test and assembly lines.*
- *Around 100 positions in radio frequency.*
- *Quality tests.*
- *Packaging internal production.*
- *Internal logistics management*
- *Qualified pre and post sales support.*



LE NOSTRE CERTIFICAZIONI - OUR CERTIFICATIONS:

Remer Rubinetterie S.p.A. è un'azienda certificata
UNI EN ISO 9001:2008 sistema di gestione qualità aziendale e
UNI EN ISO 14001: 2004 per l'impatto ambientale.

*Remer Rubinetterie S.p.A. is a
UNI EN ISO 9001:2008 certified factory for the quality system and
UNI EN ISO 14001: 2004 for environmental impact.*



LA FORZA DI UN GRANDE GRUPPO THE STRENGTH OF A BIG GROUP

Pulitura, Controllo qualità, Pre-assemblaggio,
Stampaggio plastico, Logistica.
*Polishing department, Test department, Pre-assembly department,
Injection plastic pressing department, Logistic department.*

Sede operativa e uffici
amministrativi
Head office and factory.



Cassano d'Adda (MI) - Italy
Lat: 45° 31' 37" N Long: 9° 30' 11" E



sede operativa e uffici amministrativi - *main factory and offices*



produzione high-tech, R.&D. - *high-tech production, R.&D.*

ENGINEERING 2
 produzione high-tech
 high-tech production.

ENGINEERING 1
 produzione high-tech
 high-tech production.

produzione flessibili
 flexible hoses production.



sede storica
 historical factory



produzione high-tech - high-tech production

Controllo qualità, Pre-assemblaggio,
 Stampaggio plastico, Logistica.
 Test department, Pre-assembly department, Injection
 plastic pressing department, logistic center.

produzione flessibili - production of flexibles

SOLO CARTUCCE E COMPONENTI ELETTRONICI DI ALTA QUALITÀ E MADE IN ITALY

ONLY HIGH QUALITY AND MADE IN ITALY CARTRIDGES AND ELECTRONICS

Tutti i miscelatori ed i prodotti a contenuto elettronico REMER godono di una garanzia di qualità aggiuntiva.

Cartucce a dischi ceramici per monocomando, deviatori per doccia, cartucce termostatiche e componenti elettronici sono tutti prodotti in Italia da S.T.S.R. - Studio Tecnico Sviluppo e Ricerche - con stabilimenti a Lacchiarella - MI - e sito internet www.stsr.it

S.T.S.R. nasce nel 1985 come Studio Tecnico di Sviluppo e Ricerca producendo nel corso degli anni svariati brevetti sia relativi a cartucce che a prodotti elettronici. Al suo interno sono presenti macchinari all'avanguardia che coprono il ciclo produttivo dallo stampaggio delle speciali plastiche utilizzate fino all'assemblaggio e test su macchine automatiche di ultima generazione.

Inoltre in S.T.S.R. è presente un laboratorio di analisi molto attrezzato che compie quotidianamente svariati test sui propri modelli per mantenere il controllo sulle performance dei propri prodotti.

I prodotti S.T.S.R. godono inoltre di svariate Certificazioni. È per noi importante dotare i nostri miscelatori di una cartuccia di alta qualità; i nostri clienti possono così apprezzare un acquisto che dia garanzia di affidabilità a lungo termine ed evitare le lunghe contestazioni in cui si incorre nel momento in cui il miscelatore viene dotato di cartucce di scarsa qualità e talvolta con misure non facilmente reperibili sul mercato, divenendo un danno di immagine oltre che di sostanza. Questo valore aggiunto dona agli articoli REMER caratteristiche superiori a conferma di qualità e del nostro made in ITALY.

All REMER mixers and products with electronic parts have an additional quality guarantee.

Ceramic disk cartridges for single-lever mixers, diverters for shower, thermostatic cartridges and electronic components are all produced in Italy by S.T.S.R. - Studio Tecnico Sviluppo e Ricerche - with plants in Lacchiarella - MI - and website www.stsr.it

S.T.S.R. was founded in 1985 as the Development and Research Technical Department, producing several patents related both to cartridges and electronic products over the years.

Inside there is cutting-edge machinery covering the production cycle from the molding of special plastics up to the assembly and testing of latest generation automatic machines.

Furthermore in S.T.S.R. there is a well-equipped analysis laboratory that daily performs various tests on its models to maintain control over the performance of its products.

S.T.S.R. products also have various certifications.

It is important for us to equip our mixers with a high quality cartridge; our customers can thus appreciate a purchase that guarantees long-term reliability and avoids the protracted complaints if the mixer is equipped with poor quality cartridges and sometimes with measures not easily available on the market, becoming a damage of image as well as of substance.

This added value gives to REMER articles superior characteristics as a confirmation of quality and of our made in ITALY.

CARTUCCE CARTRIDGES

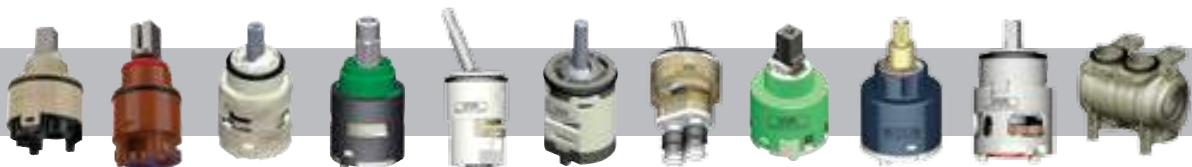

DEVIATORI DIVERTERS



CARTUCCE TERMOSTATICHE THERMOSTATIC CARTRIDGES



VITONI HEADVALVE

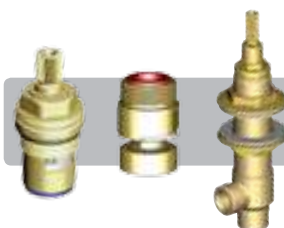

TECNOLOGIE TECHNOLOGIES





**FLESSIBILI MADE IN ITALY DI ALTA QUALITÀ
PRODOTTI CON MACCHINARI AUTOMATIZZATI A
GARANZIA DI ELEVATI STANDARD**

**MADE IN ITALY FLEXIBLE HOSES OF HIGH QUALITY
MADE BY AUTOMATIC MACHINERIES FOR A
PERFECT PRODUCT**



I prodotti REMER utilizzano solamente flessibili di alta qualità prodotti in Italia con macchinari automatizzati a garanzia di elevati standard. Flexitaly s.r.l., è una azienda facente parte del Gruppo REMER.

Nata nel 1985, Flexitaly è dotata di propri stabilimenti ed impianti che iniziano il processo produttivo partendo dalla trecciatura del tubo (gomma epdm e filo secondo specifica) e, con l'ausilio di minuterie e raccorderie create internamente con i migliori materiali seguendo minuziosamente le tolleranze e macchine automatizzate specifiche, coprono l'intero ciclo produttivo, rendendo alla clientela un prodotto completamente made in Italy, ideato e poi creato per essere totalmente performante, atossico ed estremamente durevole nel tempo.

Un ulteriore plus per i prodotti REMER.

REMER products use only high quality flexible hoses produced in Italy with automated machinery in order to guarantee high standards. Flexitaly s.r.l., is a company belonging to the REMER Group.

Founded in 1985, Flexitaly has its own plants, carrying on the production process starting from the hose braiding (epdm rubber and wire according to specification) and covering the entire production cycle with the help of small parts and fittings created in-house with the best materials, carefully following the tolerances and specific automated machines, thus offering to customers a product completely made in Italy, designed and then created to be totally performing, non-toxic and extremely durable over time.

A further plus for REMER products.

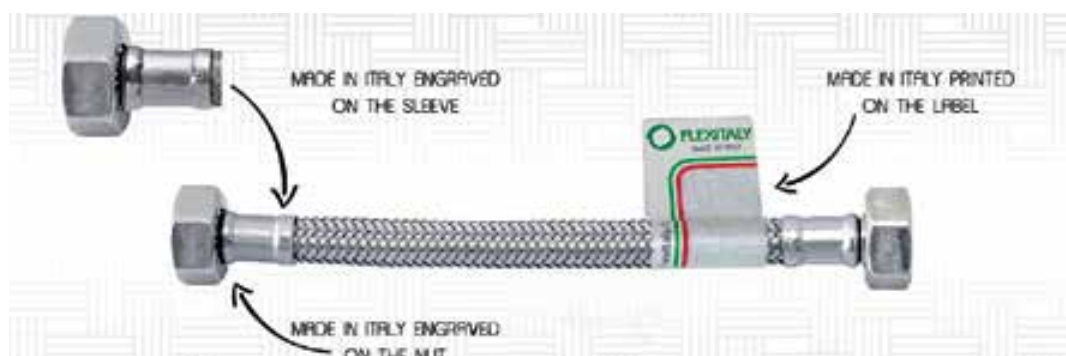

LEGENDA ICONE - *ICONS LEGEND*



Prodotto Novità
New Product



Acciaio INOX
Stainless Steel



Disponibile in finitura
Finishings available



Perfect Tune:
Prodotto disponibile
in più varianti.
Perfect Tune:
Product available
in different variants.

RUBINETTERIA - *FAUCETS*



Con scarico
With pop-up waste



Con scarico in plastica
With plastic waste



Con Click-Clack
With Click-Clak



Con Click-Clack con Troppo Pieno
With Click-Clak with Overflow



Senza Scarico
Without Waste



Eco
Eco



Cartuccia Energy Saving
Energy Saving Cartridge



Limitatore di Temperatura
Antiscalding



Risparmio Idrico Dinamico
Water Saving Dynamic



Risparmio Idrico
Water Saving



Risparmio Energetico
Energy Saving



Risparmio Idrico e Energetico
Water and Energy Saving

CUCINA - *KITCHEN*



Bocca Girevole
Swivel Spout



Corpo girevole
Swivel body



Doccetta Orientabile
Adjustable handshower



Doccetta Estraibile
Pull-Out Handshower



Bocca Abbattibile
Folding Spout



Doccetta a due funzioni
Two functions hand shower.



Acqua Frizzante
Sparkling Water



Acqua Potabile
Drinking Water

TECNOLOGIA - *TECHNOLOGY*



Touch-Me
Touch-Me



Tempor Touch
Tempor Touch



Con Luce Led
Whit Led Light



Con Batterie Alcaline Include
With Alkaline Batteries included



Alimentazione Elettrica
Power Supply



Azionamento a Sensore
Sensor Control



Con Temporizzazione per Lavatrice/Lavastoviglie
With Timing for washing/machine and Dish/Washer



Con filtro incluso
With filter included



Con Batterie al Litio Include
With Lithium Batteries included



Termostatico
Thermostatic

SOFFIONI - *SHOWER HEADS*



Getto effetto pioggia ad ampia copertura
Wide coverage rain effect



Getto effetto pioggia a risparmio idrico
Water-saving rain effect jet



Con Multigetto
With Multi Jet



Con Getto a Cascata
With Waterfall Jet



Getto Nebulizzato
Nebulized Jet



Cromoterapia
Colortherapy



Autopulente
Self-Cleaning



Con Getti Anticalcare
With Antilimestone Jets

KIT DOCCIA - *SHOWER KIT*



2 Vie
2 Ways



3 Vie
3 Ways



4 Vie
4 Ways



5 Vie
5 Ways



Flessibile Lungo 120 cm
Flexible Length 120 cm



Flessibile Lungo 150 cm
Flexible Length 150 cm



Flessibile Lungo 200 cm
Flexible Length 200 cm

DOCCHETTE - *HANDSHOWERS*



Posizione d'interruzione getto
Stop flow position



Getto intenso esterno con getto effetto pioggia interno
Intense external jet with internal rain effect jet



Getto intenso a risparmio idrico
Intense water-saving jet



Massaggio vigoroso ampia copertura effetto pioggia
Vigorous massage wide coverage rain jet



Getto vigoroso concentrato e getto esterno
Concentrated vigorous jet and external jet



Getto vigoroso concentrato
Vigorous concentrated jet



Getto Aerato Intenso
Intense Aerated Jet



Getto vigoroso effetto pioggia
Vigorous rain effect jet



Getto Vigoroso ed Ampio
Vigorous and Wide Jet



Getto spray ampia copertura e getto intenso esterno a risparmio idrico
Wide coverage spray jet and intense water saving external jet



Getto soft aerato mischiato ad un getto vigoroso a risparmio idrico
Soft aerated jet mixed with a vigorous water-saving jet



Pioggia soft a risparmio idrico
Soft rain water saving



Getto Esterno
External Jet



Con Getti Anticalcare
With Antilimestone Jets

COLONNE DOCCIA - *SHOWER COLUMNS*



Colonna Doccia Girevole
Swivable shower column



Colonna Doccia Telescopica
Telescopic shower column





ARREDARE IL BAGNO
FURNISH THE BATHROOM

DESIGN

DESIGN MINIMALE - *MINIMAL DESIGN*

CONTRACT

CLASSICA - CLASSIC

TERMOSTATICI - THERMOSTATICS

SENSOR & TEMPOR

ACCESSORI - ACCESSORIES



ABSOLUTE

pag. 22



ENERGY

pag. 34



VANITY

pag. 48



INFINITY

pag. 58



DREAM

pag. 70



CLASS LINE

pag. 80



CLASS LINE ECO

pag. 92



WINNER

pag. 98



WINNER ECO

pag. 112

ABSOLUTE

ABSOLUTE



ABSOLUTE è una collezione di rubinetteria monocomando dalle linee prevalentemente squadrate. Il miscelatore, fuso in un unico blocco, elimina qualsiasi intersezione creando un'elegante continuità nel design. Disponibile in diverse colorazioni di finitura, la rubinetteria ABSOLUTE si inserisce con gusto ed originalità in ogni progetto di arredo bagno moderno. La serie è dotata di cartuccia a dischi ceramici Ø 35 mm

ABSOLUTE is a single-lever faucet collection with a predominance of squared lines. The mixer, cast in a single block, eliminates any intersection, creating an elegant continuity of design. Available in different finishing colours, ABSOLUTE faucets fit with taste and originality in any modern bathroom furnishing project. The series is equipped with a Ø 35 mm ceramic disc cartridge



ABSOLUTE

ENERGY

VANITY

INFINITY

DREAM

CLASS LINE

CLASS LINE ECO

WINNER

WINNER ECO



NO nero opaco
matt black

BO bianco opaco
matt white



ABSOLUTE

OPZIONI DI FINITURA

Questa collezione di rubinetteria è disponibile con diverse opzioni di finitura, scegli il colore perfetto per il tuo progetto di arredo! Rispondendo alle esigenze stilistiche dei progetti più ambiziosi, Remer Rubinetterie ha selezionato colori alternativi, oltre al cromato, studiati per arricchire, personalizzare e differenziare gli interni di bagno e cucina.

[Per confermare la propria scelta, aggiungere il codice della finitura al termine del codice prodotto durante la fase di acquisto.]

ABSOLUTE

FINISHING OPTIONS

This faucet collection is available with different finishing options, choose the perfect color to customize your interior! Responding to the stylistic needs of the most ambitious designs, Remer Rubinetterie selected alternative colors, in addition to chrome, to enrich, customize and differentiate bathroom and kitchen interiors.

[To confirm your choice, add the finishing code at the end of the item code during the purchase phase.]

ABSOLUTE

ENERGY

VANITY

INFINITY

DREAM

CLASS LINE

CLASS LINE ECO

WINNER

WINNER ECO



▲
BG oro spazzolato
brushed gold



▲
NPO nichel spazzolato opaco
matt brushed nickel



CR

	cromo chrome	CR
---	-----------------	----

FIN 1

	nero opaco matt black	NO
	bianco opaco matt white	BO
	nichel spazzolato brushed nickel	NP
	nichel spazzolato opaco matt brushed nickel	NPO

FIN 2

	cromo nero spazzolato brushed black chrome	CFP
	oro spazzolato brushed gold	BG
	oro lucido shiny gold	DO



AU102L

OPZIONI MANIGLIA

La collezione è disponibile con due varianti di maniglia. Selezionare la preferenza al momento dell'ordine.

LEVER OPTIONS

The collection is available with two lever options. Select your preference before ordering.

AU 10



AU 10 2



LAVABI - WASHBASIN MIXERS

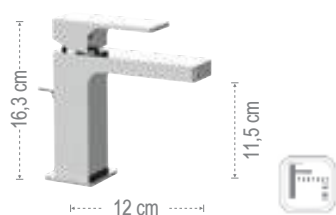

Monocomando lavabo.
Single-lever basin mixer.

AU10
con scarico.
with pop-up waste.



AU11
senza scarico.
without waste.



AU12
senza scarico e senza
foro sul corpo.
without waste and without
body hole.



AU57
Miscelatore monocomando
lavabo due fori.
Two holes single-lever
wasbasin mixer.

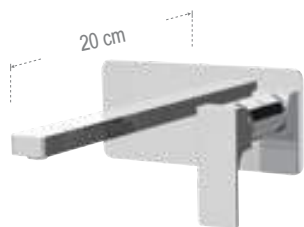

AU15
Miscelatore monocomando a
incasso per lavabo, in ottone.
Single-lever built-it basin mixer,
in brass.



AU15L
Lunghezza bocca 23 cm.
Spout length 23 cm.

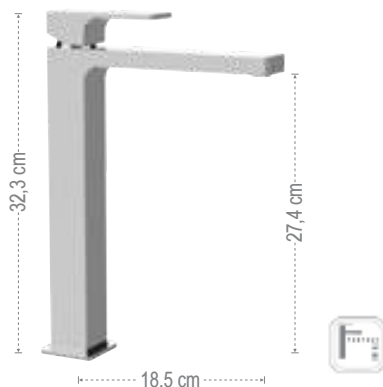

Monocomando lavabo alto senza foro sul corpo.
High basin mixer without body hole.

AU10L
con scarico click-clack
con troppopieno.
with click-clack
waste and overflow.



AU11L
senza scarico.
without waste.



AU10G
Miscelatore monocomando
lavabo, con canna corta a "U" e
scarico click-clack quadrato con
troppo pieno.
Single-lever one-hole sink
mixer, with short "U" spout, with
squared click-clack waste with
overflow.

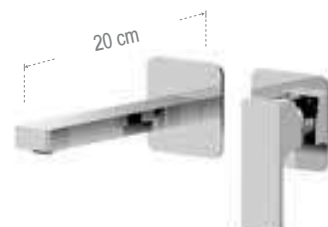

AU15P
Miscelatore monocomando a
incasso per lavabo, in ottone.
Single-lever built-it basin mixer,
in brass.



AU15PL
Lunghezza bocca 23 cm.
Spout length 23 cm.

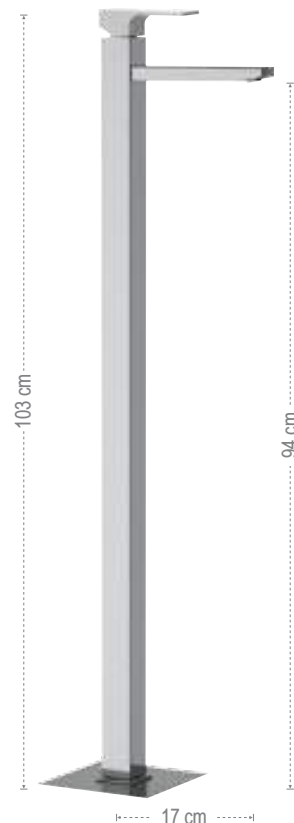

AU18
Miscelatore monocomando
lavabo da terra con scarico
click-clack con troppopieno.
Single-lever mixer for floor
mounting with click-clack
waste with overflow.



ABSOLUTE

ENERGY

VANITY

INFINITY

DREAM

CLASS LINE

CLASS LINE ECO

WINNER

WINNER ECO

LAVABO BOX INCASSO - BUILT-IN BOX WASHBASIN MIXER



AU15KB

Miscelatore monocomando a incasso per lavabo, con piastra in ottone, da abbinare al box incasso.

Single-lever built-in basin mixer, with wall flange in brass, to match with the built-in box.



RRBOX15

Box da incasso per miscelatore monocomando a incasso per lavabo.

Built-in box for single-lever built-in basin mixer.

AU15LKB

Lunghezza bocca 23cm.
Spout length 23cm.



BIDET - BIDET MIXERS



Monocomando bidet.
Single-lever bidet mixer.

AU20

con scarico.
with pop-up waste.



AU21

senza scarico.
without waste



AU22

senza scarico e senza foro sul corpo.
without waste and without body hole



Q64

Miscelatore shut-off quadrato con cartuccia progressiva, apertura su acqua fredda e passaggio ad acqua calda tramite rotazione di maniglia unica, comprensivo di doccetta shut-off 332OS e flessibile cm 120.

Shut-off square mixer with progressive cartridge, opening with cold water, switching on hot water by rotating one single handle including shut-off 332OS and flexible hose 120 cm.



Miscelatore incasso per shut-off.
Built-in shut-off mixer.

AU65

comprensivo di doccetta shut-off, supporto doccia/presa acqua, attacco conico da 1/2", tutto in ottone, flessibile doccia cm 120.
set including: shut-off, shower holder/water punch on flange all in brass, with 1/2 connection, handshower support and flexible cm 120.



AU65B

senza set doccia.
without shower kit.



VASCA - BATH MIXER



Miscelatore monocomando per vasca.
Wall mounted single-lever bath mixer.

AU02
con kit doccia e doccetta anticalcare
ad 1 funzione.
*with shower set and antiimestone
1 function handshower.*



AU05
senza set doccia.
without shower kit.

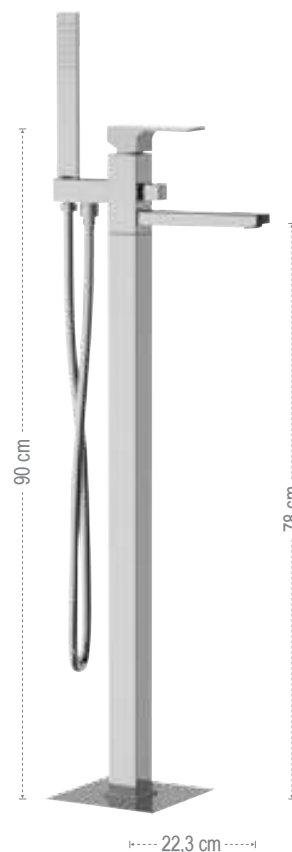

AU08
Miscelatore bordo vasca da pavimento, con deviatore e kit
doccia in ottone.
*Single-lever bath mixer floor mounting, with diverter and
brass shower kit.*



ABSOLUTE

ENERGY

VANITY

INFINITY

DREAM

CLASS LINE

CLASS LINE ECO

WINNER

WINNER ECO

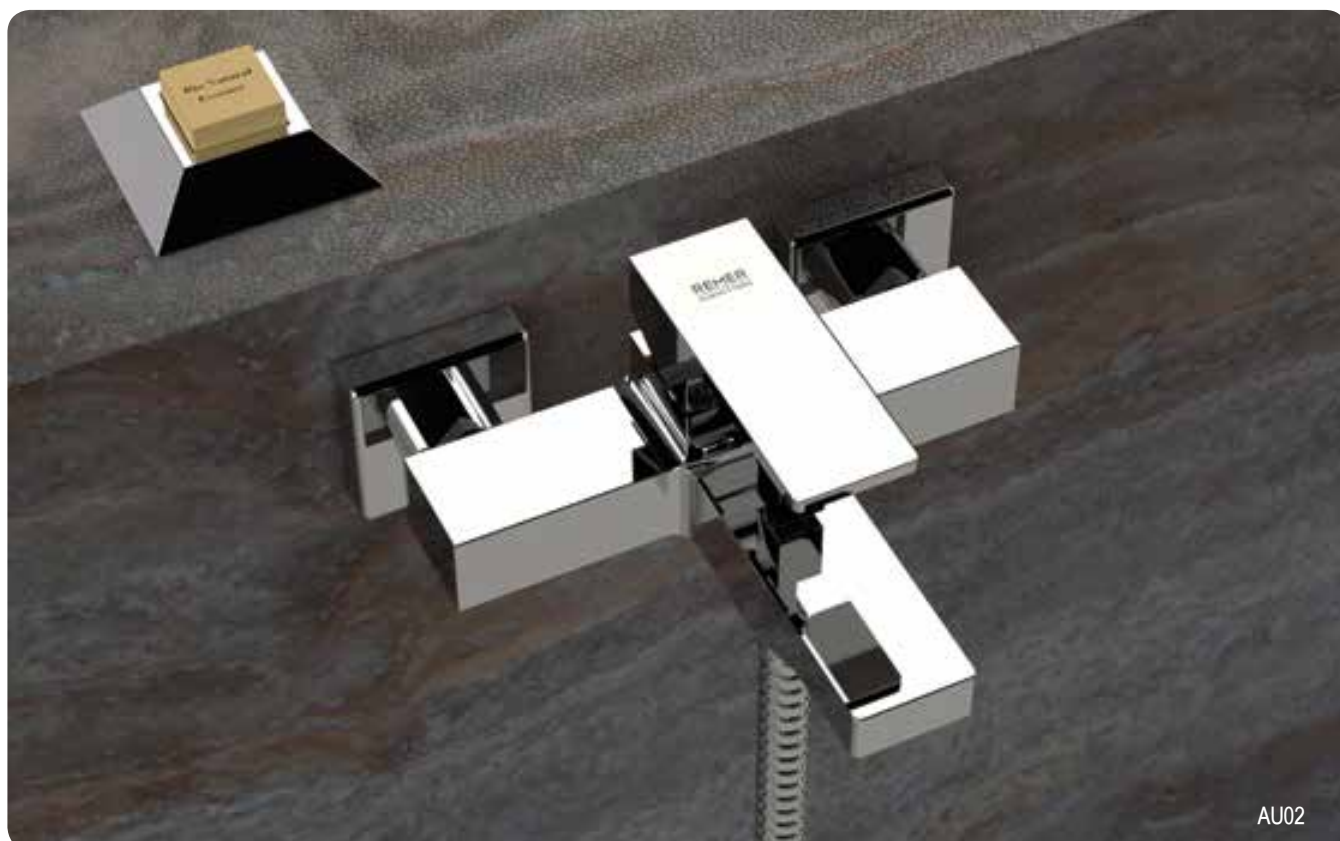

AU02

INCASSI DOCCIA - BUILT-IN MIXERS



AU30
Miscelatore monocomando a incasso per doccia completo.
Complete single lever built-in shower mixer.



N30B
Solo parte interna miscelatore monocomando incasso doccia.
Single-lever shower mixer (only built-in components).



AU30E
Solo parte esterna miscelatore monocomando incasso doccia.
Single-lever shower mixer (only external components).



AU09
Miscelatore monocomando incasso con deviatore per vasca/doccia completo.
Complete single lever built-in bath/shower mixer with diverter.



N09B
Solo parte interna miscelatore monocomando incasso vasca/doccia con deviatore.
Single-lever bath/shower mixer with diverter (only built-in components).



AU09E
Solo parte esterna miscelatore monocomando incasso vasca/doccia con deviatore.
Single-lever bath/shower mixer with diverter (only external components).



AU92
Miscelatore monocomando a incasso per doccia, con deviatore a due posizioni (due uscite ed una entrata) su piastra unica.
Single-lever built-in shower mixer with 2 positions diverter (2 outlets and 1 inlet) on single flange.



AU93
Miscelatore monocomando per doccia con deviatore a tre vie (una entrata e tre uscite) su unica piastra.
Single lever built-in shower mixer with three ways diverter (1 inlet and 3 outlets) on single flange.



AU94
Miscelatore monocomando per doccia, con deviatore a 4 posizioni (4 uscite ed 1 entrata) su piastra unica.
Single-lever shower mixer with 4 positions diverter (4 outlets and 1 inlet,) on single flange.



AU95
Miscelatore monocomando per doccia, con deviatore a 5 posizioni (5 uscite ed una entrata) su piastra unica.
Single-lever shower mixer with 5 positions diverter (5 outlets and 1 inlet,) on single flange.



BOX INCASSO - BUILT-IN BOX



RRBOX
Box da incasso per miscelatore doccia con deviatore.
Built-in box for shower mixer with diverter.

+



AU30KB
Set miscelatore doccia da abbinare al box incasso.
Shower mixer set to match with the built-in box.



OPPURE
OR



AU09KB
Set miscelatore doccia con deviatore da abbinare al box incasso.
Shower mixer set with diverter to match with the built-in box.



RRBOX92
Box da incasso per miscelatore doccia due vie.
Built-in box for two ways shower mixer.

+



AU92KB
Set miscelatore doccia due vie da abbinare al box incasso.
Two ways shower mixer set to match with the built-in box.



RRBOX93
Box da incasso per miscelatore doccia tre vie.
Built-in box for three ways shower mixer.

+



AU93KB
Set miscelatore doccia tre vie da abbinare al box incasso.
Three ways shower mixer set to match with the built-in box.



WELLNESS



Set doccia composto da: miscelatore a incasso con deviatore, soffione in abs 356SD20X, braccio quadrato in ottone 30 cm, saliscendi quadrato in ottone 317S, presa acqua a muro, doccetta quadrata in ABS, 1 funzione 317SD, flessibile 150 cm.
Shower set including: built-in mixer with diverter, abs shower head 356SD20X, square brass arm 30 cm, square brass sliding rail 317S, wall water connection, 1-function abs square hand shower 317SD, 150 cm flexible hose.

**AU09S01SD20**

Con soffione da 20x20 cm e braccio a parete 30 cm.
With shower head 20x20 cm and wall arm 30 cm.

AU09S01SD25

Con soffione da 25x25 cm e braccio a parete 30 cm.
With shower head 25x25 cm and wall arm 30 cm.

AU09S01SD30

Con soffione da 30x30 cm e braccio a parete 30 cm.
With shower head 30x30 cm and wall arm 30 cm.

AU09S21SD20

Con soffione da 20x20 cm e braccio a soffitto da 30 cm.
With shower head 20x20 cm and ceiling arm 30 cm.



Set doccia composto da: miscelatore a incasso con deviatore, soffione in abs 356SD20X, braccio quadrato in ottone 30 cm, presa acqua a muro con supporto doccetta, doccetta quadrata in ABS, 1 funzione 317SD, flessibile 150 cm.
Shower set including: built-in mixer with diverter, abs shower head 356SD20X, square brass arm 30 cm, wall water connection with shower holder, 1-function abs square hand shower 317SD, 150 cm flexible hose.

**AU09S02SD20**

Con soffione da 20x20 cm e braccio a parete 30 cm.
With shower head 20x20 cm and wall arm 30 cm.

AU09S02SD25

Con soffione da 25x25 cm e braccio a parete 30 cm.
With shower head 25x25 cm and wall arm 30 cm.

AU09S02SD30

Con soffione da 30x30 cm e braccio a parete 30 cm.
With shower head 30x30 cm and wall arm 30 cm.

AU09S22SD20

Con soffione da 20x20 cm e braccio a soffitto da 30 cm.
With shower head 20x20 cm and ceiling arm 30 cm.



Set doccia composto da: miscelatore a incasso con deviatore, soffione in acciaio inox 357UFS20X, braccio quadrato in ottone 30 cm, saliscendi quadrato in ottone 317S, presa acqua a muro, doccetta quadrata in ABS, 1 funzione 317SD, flessibile 150 cm.
Shower set including: built-in mixer with diverter, stainless steel shower head 357UFS20X, square brass arm 30 cm, square brass sliding rail 317S, wall water connection, 1-function abs square hand shower 317SD, 150 cm flexible hose.

**AU09S01UFS20**

Con soffione da 20x20 cm e braccio a parete 30 cm.
With shower head 20x20 cm and wall arm 30 cm.

AU09S01UFS25

Con soffione da 25x25 cm e braccio a parete 30 cm.
With shower head 25x25 cm and wall arm 30 cm.

AU09S01UFS30

Con soffione da 30x30 cm e braccio a parete 30 cm.
With shower head 30x30 cm and wall arm 30 cm.

AU09S21UFS20

Con soffione da 20x20 cm e braccio a soffitto da 30 cm.
With shower head 20x20 cm and ceiling arm 30 cm.



Set doccia composto da: miscelatore a incasso con deviatore, soffione in acciaio inox 357UFS20X, braccio quadrato in ottone 30 cm, presa acqua a muro con supporto doccetta, doccetta quadrata in ABS, 1 funzione 317SD, flessibile 150 cm.
Shower set including: built-in mixer with diverter, stainless steel shower head 357UFS20X, square brass arm 30 cm, wall water connection with shower holder, 1-function abs square hand shower 317SD, 150 cm flexible hose.

**AU09S02UFS20**

Con soffione da 20x20 cm e braccio a parete 30 cm.
With shower head 20x20 cm and wall arm 30 cm.

AU09S02UFS25

Con soffione da 25x25 cm e braccio a parete 30 cm.
With shower head 25x25 cm and wall arm 30 cm.

AU09S02UFS30

Con soffione da 30x30 cm e braccio a parete 30 cm.
With shower head 30x30 cm and wall arm 30 cm.

AU09S22UFS20

Con soffione da 20x20 cm e braccio a soffitto da 30 cm.
With shower head 20x20 cm and ceiling arm 30 cm.

ABSOLUTE

ENERGY

VANITY

INFINITY

DREAM

CLASS LINE

CLASS LINE ECO

WINNER

WINNER ECO



Set doccia composto da: miscelatore esterno con attacco superiore, soffione in abs 356SD20X, colonna doccia quadrata in ottone con deviatore 330S, doccetta in abs con 4 funzioni 318CP, flessibile 150 cm.
Shower set including: exposed mixer with upper connection, abs shower head 356SD20X, square brass shower column with diverter 330S, 4-function abs hand shower 318CP, 150 cm flexible hose.

Q378CPSD20

soffione in ABS anticalcare 20x20 cm.
 ABS antilimestone showerhead 20x20 cm.

Q378CPSD25

soffione in ABS anticalcare 25x25 cm.
 ABS antilimestone showerhead 25x25 cm.

Q378CPSD30

soffione in ABS anticalcare 30x30 cm.
 ABS antilimestone showerhead 30x30 cm.



Set doccia composto da: miscelatore termostatico esterno quadrato con deviatore, soffione in abs 356SD20X, colonna doccia con fissaggio superiore regolabile in altezza 329X, doccetta in abs con 4 funzioni 318CP, flessibile 150 cm.

Shower set including: square exposed thermostatic mixer with diverter, abs shower head 356SD20X, shower column with height-adjustable upper fixing 329X, 4-function abs hand shower 318CP, 150 cm flexible hose.

ST32X8CPSD20

con soffione in acciaio inox anticalcare 20x20 cm.
 with stainless steel antilimestone showerhead 20x20 cm.

ST32X8CPSD25

con soffione in acciaio inox anticalcare 25x25 cm.
 with stainless steel antilimestone showerhead 25x25 cm.

ST32X8CPSD30

con soffione in acciaio inox anticalcare 30x30 cm.
 with stainless steel antilimestone showerhead 30x30 cm.



Set doccia composto da: miscelatore esterno con deviatore vasca/doccia, soffione in abs 356SD20X, colonna doccia in ottone telescopica, altezza asta regolabile 329A, doccetta in abs con 4 funzioni 318CP, flessibile 150 cm.

Shower set including: exposed mixer with bath/shower diverter, abs shower head 356SD20X, telescopic brass shower column, with height-adjustable rod 329A, 4-function abs hand shower 318CP, 150 cm flexible hose.

AU34A8CPSD20

con soffione da 25x25 cm.
 with shower head 25x25 cm.

AU34A8CPSD25

con soffione da 25x25 cm.
 with shower head 25x25 cm.

AU34A8CPSD30

con soffione da 25x25 cm.
 with shower head 25x25 cm.



**AU93S01SSCA**

Set doccia composto da: miscelatore a incasso con deviatore a 3 vie, soffione a parete in acciaio inox con getto a pioggia e cascata 350SSCAX, saliscendi quadrato in ottone 317S, presa acqua a muro, doccetta quadrata in ottone a 1 funzione 317SS, flessibile 150 cm.

Shower set including: built-in mixer with 3-way diverter, wall mounted stainless steel shower head with rain and waterfall functions 350SSCAX, square brass sliding rail 317S, wall water connection, 1-function brass square hand shower 317SS, 150 cm flexible hose.

**AU93S02SSCA**

Set doccia composto da: miscelatore a incasso con deviatore a 3 vie, soffione a parete in acciaio inox con getto a pioggia e cascata 350SSCAX, presa acqua a muro con supporto doccetta, doccetta quadrata in ottone a 1 funzione 317SS, flessibile 150 cm.

Shower set including: built-in mixer with 3-way diverter, wall mounted stainless steel shower head with rain and waterfall functions 350SSCAX, wall water connection with shower holder, 1-function brass square hand shower 317SS, 150 cm flexible hose.



Set doccia composto da: miscelatore a incasso con deviatore a 3 vie, soffione in acciaio inox 357UFS20X, braccio quadrato in ottone 30 cm, saliscendi quadrato in ottone 317S, presa acqua a muro, doccetta quadrata in ottone a 1 funzione 317SS, 6 getti quadrati, flessibile 150 cm.

Shower set including: built-in mixer with 3-way diverter, stainless steel 20x20cm shower head 357UFS20X, square brass arm 30 cm, square brass sliding rail 317S, wall water connection, 1-function brass square hand shower 317SS, 6 square body jets, 150 cm flexible hose.



Set doccia composto da: miscelatore a incasso con deviatore a 3 vie, soffione in acciaio inox 357UFS20X, braccio quadrato in ottone 30 cm, presa acqua a muro con supporto doccetta, doccetta quadrata in ottone a 1 funzione 317SS, 6 getti quadrati, flessibile 150 cm.

Shower set including: built-in mixer with 3-way diverter, stainless steel shower head 357UFS20X, square brass arm 30 cm, wall water connection with shower holder, 1-function brass square hand shower 317SS, 6 square body jets, 150 cm flexible hose.

**AU93S01UFS20**

con soffione da cm 20x20 cm e braccio a parete 30 cm.
with shower head cm 20x20 cm and wall arm 30 cm.

AU93S01UFS25

con soffione da cm 25x25 cm e braccio a parete 30 cm.
with shower head cm 25x25 cm and wall arm 30 cm.

AU93S01UFS30

con soffione da cm 30x30 cm e braccio a parete 30 cm.
with shower head cm 30x30 cm and wall arm 30 cm.

AU93S21UFS20

con soffione da cm 20x20 cm e braccio a soffitto da 30 cm.
with shower head cm 20x20 cm and ceiling arm 30 cm.

AU93S02UFS20

con soffione da cm 20x20 cm e braccio a parete 30 cm.
with shower head cm 20x20 cm and wall arm 30 cm.

AU93S02UFS25

con soffione da cm 25x25 cm e braccio a parete 30 cm.
with shower head cm 25x25 cm and wall arm 30 cm.

AU93S02UFS30

con soffione da cm 30x30 cm e braccio a parete 30 cm.
with shower head cm 30x30 cm and wall arm 30 cm.

AU93S22UFS20

con soffione da cm 20x20 cm e braccio a soffitto da 30 cm.
with shower head cm 20x20 cm and ceiling arm 30 cm.

CON OPZIONI DI FINITURA**WITH FINISHING OPTIONS****AU09S01O20**

Set doccia composto da: miscelatore a incasso con deviatore, soffione in ottone 20x20cm 359SSX, braccio quadrato in ottone 30 cm, saliscendi quadrato in ottone 317S, presa acqua a muro, doccetta quadrata in ottone a 1 funzione 317SS, flessibile 150 cm.

Shower set including: built-in mixer with diverter, brass shower head 20x20cm 359SSX, square brass arm 30 cm, square brass sliding rail 317S, wall water connection, 1-function brass square hand shower 317SS, 150 cm flexible hose.

**AU09S02O20**

Set doccia composto da: miscelatore a incasso con deviatore, soffione in ottone 20x20cm 359SSX, braccio quadrato in ottone 30 cm, presa acqua a muro con supporto doccetta, doccetta quadrata in ottone a 1 funzione 317SS, flessibile 150 cm.

Shower set including: built-in mixer with diverter, brass shower head 20x20cm 359SSX, square brass arm 30 cm, wall water connection with shower holder, 1-function brass square hand shower 317SS, 150 cm flexible hose.



ABSOLUTE

ENERGY

VANITY

INFINITY

DREAM

CLASS LINE

CLASS LINE ECO

WINNER

WINNER ECO

ENERGY

ENERGY



La collezione di miscelatori monocomando ENERGY è una soluzione di rubinetteria versatile e moderna. Il design di ENERGY coniuga in modo armonioso raggiature morbide con superfici piatte e profilate. La fusione in ottone include la sagoma dell'aeratore che scompare così al suo interno senza interrompere la continuità visiva del miscelatore. La serie è dotata di cartuccia a dischi ceramici Ø 35 mm.

The ENERGY single-lever mixers collection is a versatile and modern faucet solution. The design of ENERGY harmoniously combines soft curvings with flat profiled surfaces. The brass shape includes the outlet shape of the aerator, which this disappears inside without interrupting the visual continuity of the mixer. The series is equipped with a Ø 35 mm ceramic disc cartridge.



ABSOLUTE

ENERGY

VANITY

INFINITY

DREAM

CLASS LINE

CLASS LINE ECO

WINNER

WINNER ECO



ENERGY

OPZIONI DI FINITURA

Questa collezione di rubinetteria è disponibile con diverse opzioni di finitura, scegli il colore perfetto per il tuo progetto di arredo! Rispondendo alle esigenze stilistiche dei progetti più ambiziosi, Remer Rubinetterie ha selezionato 2 colori, oltre al cromato, studiati per arricchire, personalizzare e differenziare gli interni di bagno e cucina.

[Per confermare la propria scelta, aggiungere il codice della finitura al termine del codice prodotto durante la fase di acquisto.]

ENERGY

FINISHING OPTIONS

This faucet collection is available with different finishing options, choose the perfect color to customize your interior!
 Responding to the stylistic needs of the most ambitious designs, Remer Rubinetterie selected 2 colors, in addition to chrome, to enrich, customize and differentiate bathroom and kitchen interiors.

[To confirm your choice, add the finishing code at the end of the item code during the purchase phase.]



NO
 ▲
 nero opaco
 matt black

ABSOLUTE

ENERGY

VANITY

INFINITY

DREAM

CLASS LINE

CLASS LINE ECO

WINNER

WINNER ECO

CR



cromo
 chrome

CR

FIN 1



nero opaco
 matt black

NO



bianco opaco
 matt white

BO



nicel spazzolato
 brushed nickel

NP



nicel spazzolato opaco
 matt brushed nickel

NPO

LAVABI - WASHBASIN MIXERS



Miscelatore monocomando lavabo.
Single-lever basin mixer.

EY10

con scarico.
with pop-up waste.



EY11

senza scarico.
without waste.



EY12

senza scarico e senza foro sul corpo.
without waste and without body hole.



Miscelatore monocomando lavabo alto L.
Single-lever high L basin mixer.

EY10L

con scarico click-clack con troppopieno.
with click-clack waste and overflow.



EY11L

senza scarico.
without waste.

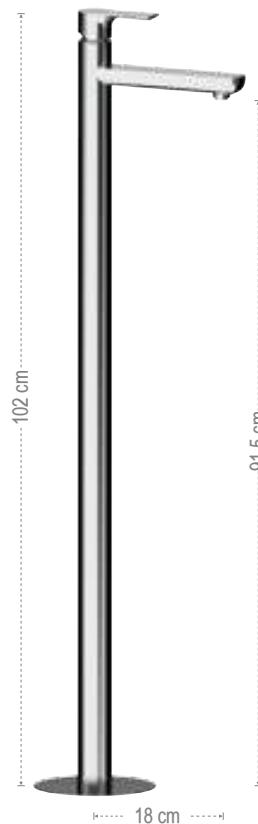

EY18

Miscelatore monocomando lavabo da terra con scarico click-clack con troppopieno.
Single-lever mixer for floor mounting with click-clack waste and overflow.



EY72C

Miscelatore monocomando lavabo senza scarico, con canna corta a "U" girevole, tipo lusso.
Single-lever basin mixer without waste, with short "U" swivel spout, luxury type.

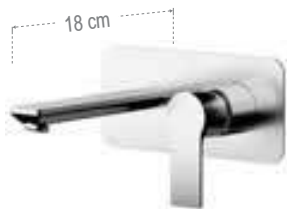

EY15

Miscelatore monocomando a incasso per lavabo, con piastra orizzontale in ottone.
Single-lever built-in basin mixer, with wall flange in brass.



91EY

Bocca incasso.
Built-in spout.



91EYL

Lunghezza bocca 23 cm.
Lenght spout 23 cm.

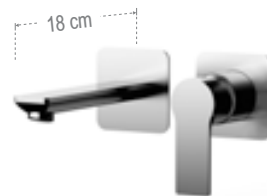

EY15P

Miscelatore monocomando a incasso per lavabo, in ottone.
Single-lever built-in basin mixer with double flanges, in brass.



EY15PL

Lunghezza bocca 23 cm.
Lenght spout 23 cm.



LAVABO BOX INCASSO - BUILT-IN BOX WASHBASIN MIXER



EY57
Miscelatore monocomando lavabo due fori, senza scarico.
Two holes single-lever washbasin mixer, without waste.



EY15KB
Miscelatore monocomando a incasso per lavabo, con piastra in ottone, bocca lunghezza 18 cm, da abbinare al box incasso.
Single-lever built-in basin mixer, with wall flange in brass, spout length 18 cm, to match with the built-in box.



RRBOX15
Box da incasso per miscelatore monocomando a incasso per lavabo.
Built-in box for single-lever built-in basin mixer.

EY15LKB
Lunghezza bocca 23 cm.
Length spout 23 cm.



BIDET - BIDET MIXERS



Miscelatore monocomando bidet.
Single-lever bidet mixer.

EY20
con scarico.
with pop-up waste.



EY21
senza scarico.
without waste.



EY22
senza scarico e senza foro sul corpo.
without waste and without body hole.



Miscelatore incasso per shut-off con supporto doccia/presa acqua integrato, attacco conico da 1/2".
Built-in shower mixer with integrated shower holder/ water punch on flange, with 1/2 connection.

EY65W
con doccetta shut-off e flessibile cm 120.
with shut-off and flexible hose cm 120.



EY65B
senza kit doccia.
without shower kit.



Miscelatore monocomando esterno doccia, interasse 100 mm.
Wall mounted single lever shower mixer, interaxis 100 mm.

EYC31DP
con doccetta shut-off e flessibile cm 120.
including shut-off and flexible hose cm 120.



EYC31
senza kit doccia.
without shower kit.



ABSOLUTE

ENERGY

VANITY

INFINITY

DREAM

CLASS LINE

CLASS LINE ECO

WINNER

WINNER ECO

VASCA - BATH MIXERS



Miscelatore vasca con deviatore integrato.
Wall mounted bath mixer with integrated diverter.

EY02

con flessibile cm 150 e doccetta a 4 funzioni con pulsante cambio getti, anticalcare e supporto snodato.
with flexible hose cm 150 and 4 functions antilimestone handshower with button to change jets and swivel shower holder.



EY05

senza kit doccia.
without shower kit.

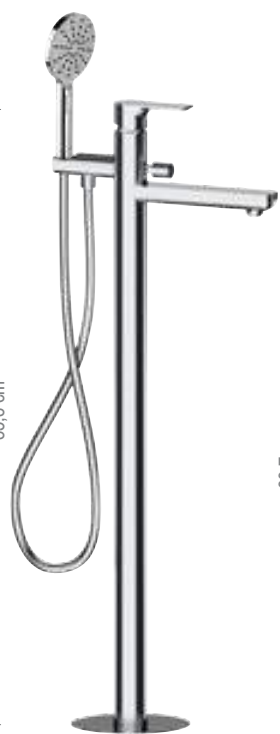

EY08

Miscelatore vasca da pavimento, con deviatore e kit doccia in ottone doccetta a 4 funzioni con pulsante cambio getti, anticalcare e flessibile 150 cm, senza scarico.
Single-lever bath mixer floor mounting, with diverter and brass shower kit, 4 functions antilimestone handshower with button to change jets and flexible hose 150 cm, without waste.



Miscelatore monocomando per vasca.
Single lever bath mixer with diverter.

EY03

con flessibile cm 150 e doccetta a 4 funzioni con pulsante cambio getti, getti in silicone anticalcare e supporto snodato.
with flexible cm 150 and 4 functions antilimestone handshower with button to change jets, silicon jets and swivel shower holder.



EY04

senza kit doccia.
without shower kit.



DOCCE - EXPOSED SHOWER MIXERS



Miscelatore doccia con leva frontale.
Exposed shower mixer with frontal lever.

EY38

con flessibile cm 150 e doccetta a 4 funzioni con pulsante cambio getti, anticalcare con supporto snodato.
with flexible cm 150 and 4 functions with button to change jets, antilimestone handshower with silicon jets and swivel shower holder.



EY33

senza kit doccia.
without shower kit.



315L318MP

Saliscendi minimale con doccetta a 4 funzioni con pulsante per il cambio getti, anticalcare.
Minimal sliding rail set with 4 function handshower, with button to change jets, antilimestone.



INCASSI DOCCIA - BUILT-IN SHOWER MIXERS

**EY30**

Miscelatore monocomando a incasso per doccia completo.
Complete single lever built-in shower mixer.

**EY09**

Miscelatore monocomando a incasso con deviatore per vasca/doccia completo.
Complete single lever built-in bath/shower mixer with diverter.

**N30B**

Solo parte interna miscelatore monocomando incasso doccia.
Single-lever shower mixer (only built-in components).

**EY30E**

Solo parte esterna miscelatore monocomando incasso doccia.
Single-lever shower mixer (only external components).

**N09B**

Solo parte interna miscelatore monocomando incasso vasca/doccia con deviatore.
Single-lever bath/shower mixer with diverter (only built-in components).

**EY09E**

Solo parte esterna miscelatore monocomando incasso vasca/doccia con deviatore.
Single-lever bath/shower mixer with diverter (only external components).

**EY30L**

Miscelatore monocomando incasso per doccia completo, con piastra lusso.
Complete single lever built-in shower mixer, with deluxe flange.

**EY09L**

Miscelatore monocomando incasso con deviatore per vasca/doccia completo, con piastra lusso.
Complete single lever built-in bath/shower mixer with diverter, with deluxe flange.

**N30B**

Solo parte interna miscelatore monocomando incasso doccia.
Single-lever shower mixer (only built-in components).

**EY30LE**

Solo parte esterna miscelatore monocomando incasso doccia, con piastra lusso.
Single-lever shower mixer (only external components), with deluxe flange.

**N09B**

Solo parte interna miscelatore monocomando incasso vasca/doccia con deviatore.
Single-lever bath/shower mixer with diverter (only built-in components).

**EY09LE**

Solo parte esterna miscelatore monocomando incasso vasca/doccia con deviatore, con piastra lusso.
Single-lever bath/shower mixer with diverter (only external components), with deluxe flange.

**EY92**

Miscelatore monocomando a incasso per doccia, con deviatore a due posizioni (due uscite ed una entrata) su piastra unica.
Single-lever built-in shower mixer with 2 positions diverter (2 outlets and 1 inlet) on single flange.

**EY93**

Miscelatore monocomando per doccia con deviatore a tre vie (una entrata e tre uscite) su unica piastra.
Single lever built-in shower mixer with three ways diverter (1 inlet and 3 outlets) on single flange.

**EY94**

Miscelatore monocomando per doccia, con deviatore a 4 posizioni (4 uscite ed 1 entrata) su piastra unica.
Single-lever shower mixer with 4 positions diverter (4 outlets and 1 inlet) on single flange.

**EY95**

Miscelatore monocomando per doccia, con deviatore a 5 posizioni (5 uscite ed una entrata) su piastra unica.
Single-lever shower mixer with 5 positions diverter (5 outlets and 1 inlet) on single flange.



ABSOLUTE

ENERGY

VANITY

INFINITY

DREAM

CLASS LINE

CLASS LINE ECO

WINNER

WINNER ECO

BOX INCASSO - BUILT-IN BOX MIXERS



RRBOX
Box da incasso per miscelatore doccia con deviatore.
Built-in box for shower mixer with diverter.

+



EY30KB
Set miscelatore doccia da abbinare al box incasso.
Shower mixer set to match with the built-in box.

OPPURE
OR



EY09KB
Set miscelatore doccia con deviatore da abbinare al box incasso.
Shower mixer set with diverter to match with the built-in box.



RRBOX92
Box da incasso per miscelatore doccia due vie.
Built-in box for two ways shower mixer.

+



EY92KB
Set miscelatore doccia due vie da abbinare al box incasso.
Two ways shower mixer set to match with the built-in box.



RRBOX93
Box da incasso per miscelatore doccia tre vie.
Built-in box for three ways shower mixer.

+



EY93KB
Set miscelatore doccia tre vie da abbinare al box incasso.
Three ways shower mixer set to match with the built-in box.



COLONNE DOCCIA - SHOWER COLUMN

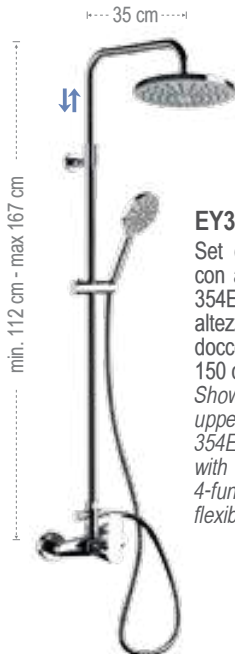

EY37AEC20
Set doccia composto da: miscelatore esterno con attacco superiore, soffione in abs Ø 20cm 354EC20X, colonna doccia in ottone telescopica, altezza asta regolabile, con deviatore 330A, doccetta in abs con 4 funzioni 318MP, flessibile 150 cm.
Shower set including: exposed mixer with upper connection, abs Ø 20 cm shower head 354EC20X, telescopic brass shower column, with height-adjustable rod, with diverter 330A, 4-function abs hand shower 318MP, 150 cm flexible hose.



Set doccia composto da: miscelatore esterno con attacco superiore, soffione in abs 356SD20X, colonna doccia in ottone telescopica, altezza asta regolabile, con deviatore 330A, doccetta in abs con 4 funzioni 318CP, flessibile 150 cm.
Shower set including: exposed mixer with upper connection, abs shower head 356SD20X, telescopic brass shower column, with height-adjustable rod, with diverter 330A, 4-function abs hand shower 318CP, 150 cm flexible hose.



EY37ASD20
Con soffione da 20x20 cm.
With shower head 20x20 cm.

EY37ASD25
Con soffione da 25x25 cm.
With shower head 25x25 cm.

EY37ASD30
Con soffione da 30x30 cm.
With shower head 30x30 cm.



EY34ASD20



EY34A EC20

Set doccia composto da: miscelatore esterno con deviatore vasca/doccia, soffione in abs Ø 20cm 354EC20X, colonna doccia in ottone telescopica, altezza asta regolabile 329A, doccetta in abs con 4 funzioni 318MP, flessibile 150 cm.

Shower set including: exposed mixer with bath/shower diverter, abs Ø 20 cm shower head 354EC20X, telescopic brass shower column, with height-adjustable rod 329A, 4-function abs hand shower 318MP, 150 cm flexible hose.



EY34A SD20

Con soffione da 20x20 cm.
With shower head 20x20 cm.

EY34A SD25

Con soffione da 25x25 cm.
With shower head 25x25 cm.

EY34A SD30

Con soffione da 30x30 cm.
With shower head 30x30 cm.



ABSOLUTE

ENERGY

VANITY

INFINITY

DREAM

CLASS LINE

CLASS LINE ECO

WINNER

WINNER ECO



Set doccia composto da: miscelatore a incasso con deviatore, soffione in abs 356SD20X, braccio in ottone 30 cm, saliscendi tondo 315L, presa acqua a muro, doccetta in abs con 4 funzioni 318MP, flessibile 150 cm.

Shower set including: built-in mixer with diverter, abs shower head 356SD20X, brass arm 30 cm, round sliding rail 315L, wall water connection, 4-function abs hand shower 318MP, 150 cm flexible hose.



EY09S01SD20

Con soffione da 20x20 cm.
With shower head 20x20 cm.

EY09S01SD25

Con soffione da 25x25 cm.
With shower head 25x25 cm.

EY09S01SD30

Con soffione da 30x30 cm.
With shower head 30x30 cm.



Set doccia composto da: miscelatore a incasso con deviatore, soffione in abs 356SD20X, braccio in ottone 30 cm, presa acqua a muro con supporto doccetta, doccetta in abs con 4 funzioni 318MP, flessibile 150 cm.

Shower set including: built-in mixer with diverter, abs shower head 356SD20X, brass arm 30 cm, wall water connection with shower holder, 4-function abs hand shower 318MP, 150 cm flexible hose.



EY09S02SD20

Con soffione da 20x20 cm.
With shower head 20x20 cm.

EY09S02SD25

Con soffione da 25x25 cm.
With shower head 25x25 cm.

EY09S02SD30

Con soffione da 30x30 cm.
With shower head 30x30 cm.



Set doccia composto da: miscelatore a incasso con deviatore, soffione in acciaio inox 357UFS20X, braccio in ottone 30 cm, saliscendi tondo 315L, presa acqua a muro, doccetta in abs con 4 funzioni 318MP, flessibile 150 cm.

Shower set including: built-in mixer with diverter, stainless steel shower head 357UFS20X, brass arm 30 cm, round sliding rail 315L, wall water connection, 4-function abs hand shower 318MP, 150 cm flexible hose.



EY09LS01UFS20

Con soffione da 20x20 cm e braccio a parete 30 cm.
With shower head 20x20 cm and wall arm 30 cm.

EY09LS01UFS25

Con soffione da 25x25 cm e braccio a parete 30 cm.
With shower head 25x25 cm and wall arm 30 cm.

EY09LS01UFS30

Con soffione da 30x30 cm e braccio a parete 30 cm.
With shower head 30x30 cm and wall arm 30 cm.

EY09LS21UFS20

Con soffione da 20x20 cm e braccio a soffitto da 30 cm.
With shower head 20x20 cm and ceiling arm 30 cm.



Set doccia composto da: miscelatore a incasso con deviatore, soffione in acciaio inox 357UFS20X, braccio in ottone 30 cm, presa acqua a muro con supporto doccetta, doccetta in abs con 4 funzioni 318MP, flessibile 150 cm.

Shower set including: built-in mixer with diverter, stainless steel shower head 357UFS20X, brass arm 30 cm, wall water connection with shower holder, 4-function abs hand shower 318MP, 150 cm flexible hose.



EY09LS02UFS20

Con soffione da 20x20 cm e braccio a parete 30 cm.
With shower head 20x20 cm and wall arm 30 cm.

EY09LS02UFS25

Con soffione da 25x25 cm e braccio a parete 30 cm.
With shower head 25x25 cm and wall arm 30 cm.

EY09LS02UFS30

Con soffione da 30x30 cm e braccio a parete 30 cm.
With shower head 30x30 cm and wall arm 30 cm.

EY09LS22UFS20

Con soffione da 20x20 cm e braccio a soffitto da 30 cm.
With shower head 20x20 cm and ceiling arm 30 cm.

CON OPZIONI DI FINITURA  **WITH FINISHING OPTIONS**
**EY09LS010**

Set doccia composto da: miscelatore a incasso con deviatore, soffione in ottone 20x20cm 359SSX, braccio in ottone 30 cm, saliscendi in ottone 317G, presa acqua a muro, doccetta quadrata in ottone a 1 funzione 317SS, flessibile 150 cm.

Shower set including: built-in mixer with diverter, brass shower head 20x20cm 359SSX, brass arm 30 cm, brass sliding rail 317G, wall water connection, 1-function brass square hand shower 317SS, 150 cm flexible hose.

**EY09LS020**

Set doccia composto da: miscelatore a incasso con deviatore, soffione in ottone 20x20cm 359SSX, braccio in ottone 30 cm, presa acqua a muro con supporto doccetta, doccetta quadrata in ottone a 1 funzione 317SS, flessibile 150 cm.

Shower set including: built-in mixer with diverter, brass shower head 20x20cm 359SSX, brass arm 30 cm, wall water connection with shower holder, 1-function brass square hand shower 317SS, 150 cm flexible hose.



EY09S02SD20

ABSOLUTE

ENERGY

VANITY

INFINITY

DREAM

CLASS LINE

CLASS LINE ECO

WINNER

WINNER ECO

CUCINA - KITCHEN MIXERS

**EY84**

Miscelatore monocomando per lavello, con canna alta girevole e sistema di doccetta monofunzione estraibile.

Single-lever sink mixer with high swivel spout and single-function system pull-out hand shower.

**EY84DJ**

Miscelatore monocomando per lavello, con canna alta girevole e doccetta estraibile a due funzioni.

Single-lever sink mixer with high swivel spout and 2-functions pull-out hand shower.

**EY81M**

Miscelatore monocomando per lavello, con canna alta girevole e doccetta estraibile con impugnatura a martello a due funzioni.

Single-lever sink mixer with high swivel spout and 2-functions pull-out "hammer shaped" handle hand shower.



EY84



EY72
Miscelatore monocomando monoforo 90°, con canna alta girevole.
Single-lever sink mixer 90°, high swivel spout.



EY72U
Miscelatore monocomando monoforo 90°, con canna alta girevole a "U".
Single-lever sink mixer 90°, high swivel "U" spout.



EY42B
Miscelatore monocomando per lavello, con bocca alta girevole.
Single-lever one-hole sink mixer, with high swivel spout.



EY42BC
Miscelatore monocomando per lavello, con bocca corta girevole.
Single-lever one-hole sink mixer, with short swivel spout.



EY42R
Miscelatore monocomando monoforo 90° per lavello, con bocca alta girevole ed abbattibile, tipo lusso, modello sottofinestra.
Single-lever one-hole sink mixer, with high spout swivel and folding, luxury type, under window type.



EY43B
Miscelatore monocomando per lavello a muro, con leva frontale e bocca alta a "U" girevole.
Single-lever wall mounted sink mixer, with frontal lever and high swivel "U" spout.



EY41
Miscelatore monocomando per lavello a muro.
Single-lever wall mounted sink mixer.



ACQUA PURIFICATA
PURIFIED WATER



EY541
Miscelatore lavello con flessibile rivestito in tubo gomma soft-touch nero opaco.
Sink mixer with flexible hose coated in soft-touch matt black rubber pipe.

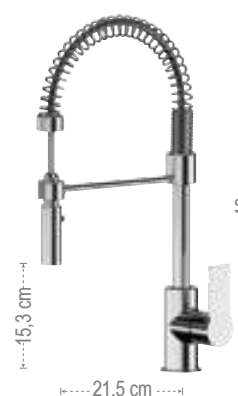

EY77E
Miscelatore monocomando lavello a molla con doccetta estraibile dal supporto ed orientabile a due funzioni.
Spring single-lever sink mixer with detachable and adjustable 2-functions handshower.



EY79DW
Miscelatore lavello a tre vie di ingresso con bocca girevole e due vie d'uscita completamente indipendenti, con selezione acqua filtrata tramite la leva aggiuntiva.
Three ways inlet single lever sink mixer, with swivel spout and two fully independent outlets, with selection for drinking water on a separate lever.



VANITY

VANITY



Il design della collezione di rubinetteria monocomando VANITY si contraddistingue per la sua grazia e per la continuità delle linee morbide che includono nel corpo del miscelatore sia la basetta che l'aeratore. Ne risulta un'unica figura scultorea, senza spigoli e intersezioni che dota gli arredi bagno di una naturale eleganza.

La serie è dotata di cartuccia a dischi ceramici Ø 35 mm.

The design of VANITY single-lever faucet collection is characterized by its grace and by the continuity of its soft lines that include both the base and the aerator within the mixer body. The result is a unique sculptural figure, without edges and intersections that endows the bathroom furnishings with a natural elegance.

The series is equipped with a Ø 35 mm ceramic disc cartridge.



ABSOLUTE

ENERGY

VANITY

INFINITY

DREAM

CLASS LINE

CLASS LINE ECO

WINNER

WINNER ECO



▲
NPO nichel spazzolato opaco
matt brushed nickel

▲
BG oro spazzolato
brushed gold

VANITY

OPZIONI DI FINITURA

Questa collezione di rubinetteria è disponibile con diverse opzioni di finitura, scegli il colore perfetto per il tuo progetto di arredo! Rispondendo alle esigenze stilistiche dei progetti più ambiziosi, Remer Rubinetterie ha selezionato colori alternativi, oltre al cromato, studiati per arricchire, personalizzare e differenziare gli interni di bagno e cucina.

[Per confermare la propria scelta, aggiungere il codice della finitura al termine del codice prodotto durante la fase di acquisto.]

VANITY

FINISHING OPTIONS

This faucet collection is available with different finishing options, choose the perfect color to customize your interior! Responding to the stylistic needs of the most ambitious designs, Remer Rubinetterie selected alternative colors, in addition to chrome, to enrich, customize and differentiate bathroom and kitchen interiors.

[To confirm your choice, add the finishing code at the end of the item code during the purchase phase.]



NO nero opaco
matt black

BO bianco opaco
matt white

ABSOLUTE

ENERGY

VANITY

INFINITY

DREAM

CLASS LINE

CLASS LINE ECO

WINNER

WINNER ECO

CR

	cromo chrome	CR
---	-----------------	----

FIN 1

	nero opaco matt black	NO
	bianco opaco matt white	BO
	nicel spazzolato brushed nickel	NP
	nicel spazzolato opaco matt brushed nickel	NPO

FIN 2

	cromo nero spazzolato brushed black chrome	CFP
	oro spazzolato brushed gold	BG



V10 (FIN1 - NO)

LAVABI - WASHBASIN MIXERS



Miscelatore monocomando lavabo.
Single-lever basin mixer.

V10
con scarico.
with pop-up waste.



V11
senza scarico.
without waste.



V12
senza scarico e senza foro
sul corpo.
without waste and without
body hole.

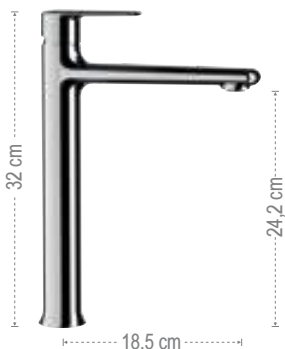

Miscelatore monocomando lavabo alto L.
L high single-lever basin mixer.

V10L
con scarico click-clack
con troppopieno.
with click-clack
waste and overflow



V11L
senza scarico.
without waste.



V72C
Miscelatore monocomando
lavabo senza scarico, con
canna corta a "U", tipo lusso.
Single-lever basin mixer
without waste, with short "U"
spout, luxury type.



V15
Miscelatore monocomando a
incasso per lavabo, con piastra
in ottone.
Single-lever built-in basin
mixer, with wall flange in
brass.

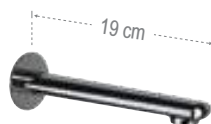

91V
Bocca incasso.
Built-in spout.



V57
Miscelatore monocomando
lavabo due fori senza scarico.
Two holes single-lever
washbasin mixer.



LAVABO BOX INCASSO - BUILT-IN BOX WASHBASIN MIXER



V15KB
Miscelatore monocomando a
incasso per lavabo, con piastra
in ottone, da abbinare al box
incasso.
Single-lever built-in basin mixer,
with wall flange in brass, to
match with the built-in box.



+



RRBOX15
Box da incasso per miscelatore monocomando a
incasso per lavabo.
Built-in box for single-lever built-in basin mixer.

BIDET - BIDET MIXERS



Miscelatore monocomando bidet.
Single-lever bidet mixer.

V20

con scarico.
with pop-up waste.



V21

senza scarico.
without waste.



V22

senza scarico e senza foro
sul corpo.
without waste and without
body hole.



Miscelatore incasso per shut-off.
Shut-off built-in shower mixer.

V65W

kit con doccetta shut-off, supporto
doccia/presa acqua, attacco conico
da 1/2", tutto in ottone, flessibile cm
120.

kit including: shut-off, shower
holder/water punch on flange
all in brass, with 1/2 connection,
handshower support and flexible
cm 120.



V65B

senza kit doccia.
without shower kit.



V60W

Miscelatore incasso per shut-off
comprensivo di: doccetta shut-
off, supporto doccia-presa acqua
su piastra in ottone e flessibile
cm 120.

Built-in shower mixer set
including: shut-off, shower
holder-water punch on flange, all
in brass and shower flexible cm
120.



MISCELATORI VASCA E DOCCIA - SHOWER AND BATH MIXERS



Miscelatore vasca.
Exposed bath mixer.

V02

con doccetta anticalcare a 4 funzioni con pulsante
per cambio getti e flessibile 150 cm.
with 4 functions antilimestone handshower with
button to change the jets flexible hose 150 cm.



V05

senza kit doccia.
without shower kit.



Monocomando doccia.
Exposed shower mixer.

V38

con doccetta anticalcare a 4 funzioni con pulsante
per cambio getti e flessibile 150 cm.
with 4 functions antilimestone handshower with
button to change the jets flexible hose 150 cm.



V33

senza kit doccia.
without shower kit.



317V315P3I

Saliscendi con asta minimale ovale, con doccetta
anticalcare a 4 funzioni, pulsante per il cambio dei getti
anticalcare in silicone, flessibile in acciaio inox 150 cm.
Sliding rail set with minimal oval rod and
antilimestone 4 functions handshower with button to
change the jets with flexible hose in stainless steel,
150 cm.



INCASSI DOCCIA - BUILT-IN MIXERS



V30
Miscelatore monocomando a incasso per doccia completo.
Complete single lever built-in shower mixer.



V09
Miscelatore monocomando a incasso con deviatore per vasca/doccia completo.
Complete single lever built-in bath/shower mixer with diverter.



N30B

Solo parte interna miscelatore monocomando incasso doccia.
Single-lever shower mixer (only built-in components).



V30E

Solo parte esterna miscelatore monocomando incasso doccia.
Single-lever shower mixer (only external components).



N09B

Solo parte interna miscelatore monocomando incasso vasca/doccia con deviatore.
Single-lever bath/shower mixer with diverter (only built-in components).



V09E

Solo parte esterna miscelatore monocomando incasso vasca/doccia con deviatore.
Single-lever bath/shower mixer with diverter (only external components).



V92
Miscelatore monocomando per doccia con deviatore a 2 posizioni su piastra unica.
Single-lever shower mixer, with 2 positions diverter on single flange.



V93
Miscelatore monocomando per doccia con deviatore a 3 vie e 3 posizioni (una entrata e tre uscite) su unica piastra.
Single lever built-in shower mixer with 3 ways diverter and 3 positions (1 inlet and 3 outlets) on single flange.



V94
Miscelatore monocomando per doccia, con deviatore a 4 posizioni (4 uscite ed 1 entrata) su piastra unica.
Single-lever shower mixer with 4 positions diverter (4 outlets and 1 inlet,) on single flange.



V95
Miscelatore monocomando per doccia, con deviatore a 5 posizioni (5 uscite ed una entrata) su piastra unica.
Single-lever shower mixer with 5 positions diverter (5 outlets and 1 inlet,) on single flange.



BOX INCASSO - BUILT-IN BOX



RRBOX
Box da incasso per miscelatore doccia con deviatore.
Built-in box for shower mixer with diverter.

+



V30KB
Set miscelatore doccia da abbinare al box incasso.
Shower mixer set to match with the built-in box.

OPPURE
OR



V09KB
Set miscelatore doccia con deviatore da abbinare al box incasso.
Shower mixer set with diverter to match with the built-in box.



RRBOX92
Box da incasso per miscelatore doccia due vie.
Built-in box for two ways shower mixer.

+



V92KB
Set miscelatore doccia due vie da abbinare al box incasso.
Two ways shower mixer set to match with the built-in box.



RRBOX93
Box da incasso per miscelatore doccia tre vie.
Built-in box for three ways shower mixer.

+



V93KB
Set miscelatore doccia tre vie da abbinare al box incasso.
Three ways shower mixer set to match with the built-in box.



ABSOLUTE

ENERGY

VANITY

INFINITY

DREAM

CLASS LINE

CLASS LINE ECO

WINNER

WINNER ECO

SALISCENDI E COLONNE DOCCIA - SLIDING RAILS AND SHOWER COLUMN



V34A5P3AD20

Set doccia composto da: miscelatore esterno con deviatore vasca/doccia, soffione in abs 20x20cm con angoli arrotondati 356AD20X, colonna doccia in ottone telescopica, altezza asta regolabile 329A, doccetta in abs con 4 funzioni 315P3, flessibile 150 cm.

Shower set including: exposed mixer with bath/shower diverter, abs 20x20 cm shower head with rounded corners 356AD20X, telescopic brass shower column, with height-adjustable rod 329A, 4-function abs hand shower 315P3, 150 cm flexible hose.

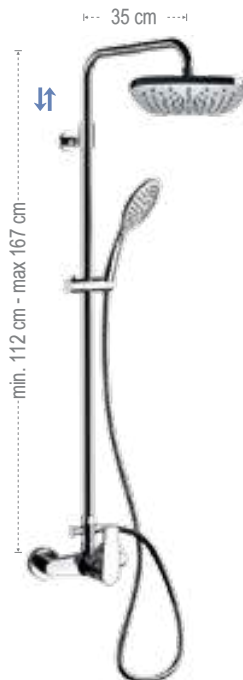

V37A5P3AD20

Set doccia composto da: miscelatore esterno con attacco superiore, soffione in abs 20x20cm con angoli arrotondati 356AD20X, colonna doccia in ottone telescopica, altezza asta regolabile, con deviatore 330A, doccetta in abs con 4 funzioni 315P3, flessibile 150 cm.

Shower set including: exposed mixer with upper connection, abs 20x20 cm shower head with rounded corners 356AD20X, telescopic brass shower column, with height-adjustable rod, with diverter 330A, 4-function abs hand shower 315P3, 150 cm flexible hose.



WELLNESS



V09S01

Set doccia composto da: miscelatore a incasso con deviatore, soffione in abs 20x20cm con angoli arrotondati 356AD20X, braccio in ottone 30 cm, saliscendi con asta ovale 317V, presa acqua a muro, doccetta in abs con 4 funzioni 315P3, flessibile 150 cm.

Shower set including: built-in mixer with diverter, abs 20x20 cm shower head with rounded corners 356AD20X, brass arm 30 cm, sliding rail with oval rod 317V, wall water connection, 4-function abs hand shower 315P3, 150 cm flexible hose.



V09S02

Set doccia composto da: miscelatore a incasso con deviatore, soffione in abs 20x20cm con angoli arrotondati 356AD20X, braccio in ottone 30 cm, presa acqua a muro con supporto doccetta, doccetta in abs con 4 funzioni 315P3, flessibile 150 cm.

Shower set including: built-in mixer with diverter, abs 20x20 cm shower head with rounded corners 356AD20X, brass arm 30 cm, wall water connection with shower holder, 4-function abs hand shower 315P3, 150 cm flexible hose.





ABSOLUTE

ENERGY

VANITY

INFINITY

DREAM

CLASS LINE

CLASS LINE ECO

WINNER

WINNER ECO

CUCINA - KITCHEN MIXERS

**V72**

Miscelatore monocomando monoforo 90°, con canna alta a "U".
Single-lever sink mixer 90°, high "U" spout.

**V42B**

Miscelatore monocomando per lavello, con bocca alta girevole.
Single-lever one-hole sink mixer, with high swivel spout.

**V77E**

Miscelatore monocomando lavello a molla con doccetta estraibile dal supporto ed orientabile a due funzioni e cartuccia Ø 35.
Spring single-lever sink mixer with detachable and adjustable 2-functions handshower and Ø 35 mm cartridge.

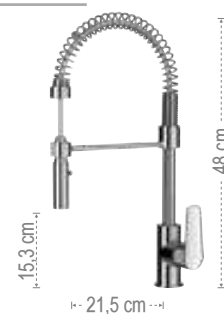
ACQUA PURIFICATA
PURIFIED WATER**V84**

Miscelatore monocomando per lavello, con canna alta girevole e sistema di doccetta monofunzione estraibile.
Single-lever sink mixer with high swivel spout and single-function system pull-out hand shower.

**V84DJ**

Miscelatore monocomando per lavello, con canna alta girevole e doccetta estraibile a due funzioni.
Single-lever sink mixer with high swivel spout and 2-functions pull-out hand shower.

**V79DW**

Miscelatore lavello a 3 vie di ingresso con bocca girevole e 2 vie d'uscita completamente indipendenti, con selezione acqua potabile tramite la leva.
Three ways inlet single lever sink mixer, with swivel spout and two fully independent outlets, with selection for drinking water directly from the lever.



INFINITY

INFINITY



Infinity nasce da un'idea di design in cui la resa estetica di leggerezza del prodotto ricopre un ruolo di primaria importanza. La morbidezza del corpo ed i suoi raggi addolciti sono interrotti in corrispondenza della bocca di erogazione e della leva, entrambe caratterizzate dallo stesso profilo, estremamente assottigliate e con una superficie superiore completamente piana. La serie è dotata di cartuccia a dischi ceramici Ø 35 mm.

Infinity was born from an idea of design in which a role of primary importance is given to the final impact of lightness that the whole line gives. The smoothness of the body and its wide rays are interrupted in correspondance of the spout and the lever which suddenly show a completely flat upper surface. The series is equipped with a Ø 35 mm ceramic disc cartridge.



ABSOLUTE

ENERGY

VANITY

INFINITY

DREAM

CLASS LINE

CLASS LINE ECO

WINNER

WINNER ECO



▲
BG oro spazzolato
brushed gold



▲
DO oro lucido
shiny gold

INFINITY

OPZIONI DI FINITURA

Questa collezione di rubinetteria è disponibile con diverse opzioni di finitura, scegli il colore perfetto per il tuo progetto di arredo!

Rispondendo alle esigenze stilistiche dei progetti più ambiziosi, Remer Rubinetterie ha selezionato colori alternativi, oltre al cromato, studiati per arricchire, personalizzare e differenziare gli interni di bagno e cucina.

[Per confermare la propria scelta, aggiungere il codice della finitura al termine del codice prodotto durante la fase di acquisto.]

INFINITY

FINISHING OPTIONS

This faucet collection is available with different finishing options, choose the perfect color to customize your interior!

Responding to the stylistic needs of the most ambitious designs, Remer Rubinetterie selected alternative colors, in addition to chrome, to enrich, customize and differentiate bathroom and kitchen interiors.

[To confirm your choice, add the finishing code at the end of the item code during the purchase phase.]



ABSOLUTE

ENERGY

VANITY

INFINITY

DREAM

CLASS LINE

CLASS LINE ECO

WINNER

WINNER ECO

BO bianco opaco
matt white

NO nero opaco
matt black

CR



cromo
chrome

CR

FIN 1



nero opaco
matt black

NO



bianco opaco
matt white

BO



nicel spazzolato
brushed nickel

NP



nicel spazzolato opaco
matt brushed nickel

NPO

FIN 2



oro spazzolato
brushed gold

BG



oro lucido
shiny gold

DO

LAVABI - WASHBASIN MIXERS



Miscelatore monocomando lavabo.
Single-lever basin mixer.

I10

con scarico.
with pop-up waste.



I11

senza scarico.
without waste.



I12

senza scarico e
senza foro sul
corpo.
*without waste and
without body hole.*



Miscelatore monocomando lavabo.
Single-lever basin mixer.

I10L

con scarico
click-clack con
troppopieno.
*with click-clack
waste and overflow*



I11L

senza scarico.
without waste.



Miscelatore monocomando lavabo
alto XXL.
XXL high single-lever basin mixer.

I10LXXL

con scarico
click-clack con
troppopieno.
*with click-clack
waste and overflow*



I11LXXL

senza scarico.
without waste.

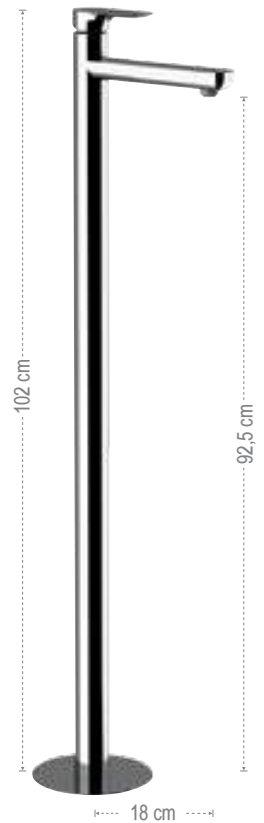

I18

Miscelatore monocomando lavabo
da terra con scarico click-clack con
troppopieno.
*Single-lever mixer for floor mounting.
with click-clack waste with overflow.*



I72C

Miscelatore monocomando lavabo,
con canna corta girevole, tipo lusso.
*Single-lever basin mixer without
waste, with short swivel spout,
luxury type.*



I57

Miscelatore monocomando lavabo
due fori senza scarico.
*Two holes single-lever
washbasin mixer without waste.*

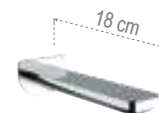

911

Bocca incasso.
Built-in spout.



911L

Lunghezza bocca 23cm.
Spout length 23cm.



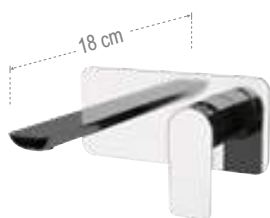

I15
Miscelatore monocomando a incasso per lavabo, con piastra in ottone.
Single-lever built-in basin mixer, with wall flange in brass.

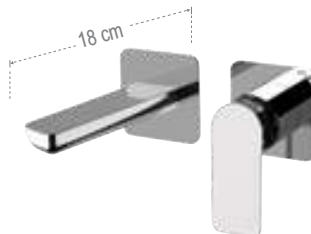

I15P
Miscelatore monocomando a incasso per lavabo, con piastra in ottone.
Single-lever built-in basin mixer, with wall flange in brass.



I15L
Lunghezza bocca 23 cm.
Length spout 23 cm.



I15PL
Lunghezza bocca 23 cm.
Length spout 23 cm.



LAVABO BOX INCASSO - BUILT-IN BOX WASHBASIN MIXER



+



I15KB
Miscelatore monocomando a incasso per lavabo, con piastra in ottone, bocca lunghezza 18 cm, da abbinare al box incasso.
Single-lever built-in basin mixer, with wall flange in brass, spout length 18 cm, to match with the built-in box.



RRBOX15
Box da incasso per miscelatore monocomando a incasso per lavabo.
Built-in box for single-lever built-in basin mixer.

I15LKB
Lunghezza bocca 23 cm.
Length spout 23 cm.



BIDET - BIDET MIXERS



Monocomando bidet.
Single-lever bidet mixer.

I20
con scarico.
with pop-up waste.



I21
senza scarico.
without pop-up waste.



Miscelatore monocomando esterno doccia, interasse 10 cm per shut-off.
Shut-off wall mounted single lever shower mixer, interaxis 10 cm

IC31REW
con doccetta a pulsante, flessibile 120 cm e supporto in ottone.
with shut-off handshower, flexible hose cm 120 and brass shower holder.



IC31
senza kit doccia.
without shower kit.



Miscelatore incasso per shut-off con supporto doccia/presa acqua integrato, attacco conico da 1/2", tutto in ottone.
Built-in shower mixer with integrated shower holder/water punch on flange all in brass, with 1/2 connection.

I65W
con doccetta shut-off e flessibile cm 120.
including shut-off and flexible hose cm 120.



I65B
senza kit doccia.
without shower kit.



I60W
Miscelatore incasso shut-off coprensivo di: doccetta shut-off, supporto doccia-presa acqua, tutto in ottone e flessibile cm 120.
Built-in shower mixer set including: shut-off, shower holder water punch, all in brass and flexible hose cm 120



ABSOLUTE

ENERGY

VANITY

INFINITY

DREAM

CLASS LINE

CLASS LINE ECO

WINNER

WINNER ECO

VASCA - BATH MIXERS



Miscelatore vasca.
Wall mounted bath mixer.

I02

con flessibile cm 150 e doccetta ovale ad 1
funzione con getti anticalcare.
with flexible hose cm 150 and 1 function
antilimestone oval handshower.



I05

senza kit doccia.
without shower kit.



Miscelatore lavabo/vasca con canna fusa lunga 30 cm
e deviatore.
Wall basin/bath single lever mixer with cm 30 long
casted spout with diverter.

I49

con flessibile cm 150 e doccetta ovale ad 1
funzione con getti anticalcare.
with flexible hose cm 150 and 1 function
antilimestone oval handshower.



I46

senza kit doccia.
without shower kit.

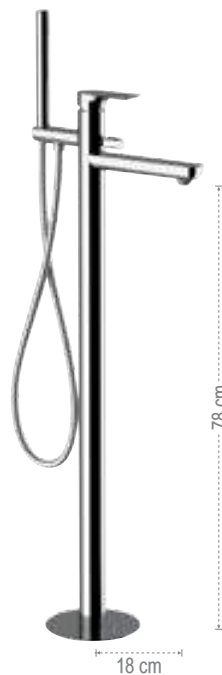

I08

Miscelatore bordo vasca da
pavimento, con deviatore
e doccetta ad 1 funzione e
flessibile 150 cm in ottone.
Single-lever bath mixer floor
mounting, with diverter and brass
1 function handshower and
flexible hose 150 cm.



I07

Miscelatore monocomando bordo vasca con deviatore
a leva integrato nella bocca minimale e doccetta
estraibile ad 1 funzione anticalcare.
Single lever deck bath mixer with with lever
diverter integrated on the spout, with minimal
spout and pull-out 1 function antilimestone
handshower.



I07UF

Miscelatore monocomando bordo vasca con
deviatore integrato nel miscelatore, bocca a
cascata e doccetta ad 1 funzione anticalcare.
Single lever deck bath mixer with diverter
integrated on the mixer, with waterfall spout and
antilimestone pull-out 1 function handshower.



I27

Miscelatore bordo vasca con deviatore integrato
nel miscelatore e doccetta anticalcare ad 1
funzione estraibile.
Single lever bath deck mixer with diverter
integrated on the mixer and pull-out 1 function
antilimestone handshower.



DOCCE - WALL MOUNTED SHOWER MIXERS

ABSOLUTE

ENERGY

VANITY

INFINITY

DREAM

CLASS LINE

CLASS LINE ECO

WINNER

WINNER ECO



Miscelatore doccia con leva frontale.
Wall mounted shower mixer with frontal lever.

IR38

con flessibile cm 150 e doccetta ovale ad 1 funzione con getti in anticalcare.
with flexible hose cm 150 and 1 function antilimestone oval handshower.



IR33

senza kit doccia.
without shower kit.



Miscelatore doccia.
Wall mounted.

I39

con flessibile cm 150 e doccetta ovale ad 1 funzione con getti anticalcare.
with flexible hose cm 150 and 1 function antilimestone oval handshower.



I31

senza kit doccia.
without shower kit.



317V317RV

Saliscendi cromato con asta minimale ovale dritta, flessibile in ottone 150 cm e doccetta ovale ad 1 funzione con getti anticalcare.
Sliding rail set with minimal oval rod, brass flexible hose 150 cm and 1 function antilimestone oval handshower.

INCASSI DOCCIA - BUILT-IN MIXERS



I30

Miscelatore monocomando a incasso per doccia completo.
Complete single lever built-in shower mixer.



I09

Miscelatore monocomando a incasso con deviatore per vasca/doccia completo.
Complete single lever built-in bath/shower mixer with diverter.



N30B

Solo parte interna miscelatore monocomando incasso doccia.
Single-lever shower mixer (only built-in components).



I30E

Solo parte esterna miscelatore monocomando incasso doccia.
Single-lever shower mixer (only external components).



N09B

Solo parte interna miscelatore monocomando incasso vasca/doccia con deviatore.
Single-lever bath/shower mixer with diverter (only built-in components).



I09E

Solo parte esterna miscelatore monocomando incasso vasca/doccia con deviatore.
Single-lever bath/shower mixer with diverter (only external components).



I92

Miscelatore monocomando per doccia, con deviatore a due posizioni (due uscite ed una entrata) su piastra unica.
Single-lever shower mixer with 2 positions diverter (2 outlets and 1 inlet) on single flange.



I93

Miscelatore monocomando per doccia con deviatore a tre vie (una entrata e tre uscite) su unica piastra.
Single lever built-in shower mixer with three ways diverter (1 inlet and 3 outlets) on single flange.



I94

Miscelatore monocomando per doccia, con deviatore a 4 posizioni (4 uscite ed 1 entrata) su piastra unica.
Single-lever shower mixer with 4 positions diverter (4 outlets and 1 inlet,) on single flange.



I95

Miscelatore monocomando per doccia, con deviatore a 5 posizioni (5 uscite ed una entrata) su piastra unica.
Single-lever shower mixer with 5 positions diverter (5 outlets and 1 inlet) on single flange.



BOX INCASSO - BUILT-IN BOX



RRBOX

Box da incasso per miscelatore doccia con deviatore.
Built-in box for shower mixer with diverter.

+



I30KB

Set miscelatore doccia da abbinare al box incasso.
Shower mixer set to match with the built-in box.

OPPURE
OR



I09KB

Set miscelatore doccia con deviatore da abbinare al box incasso.
Shower mixer set with diverter to match with the built-in box.



RRBOX92

Box da incasso per miscelatore doccia due vie.
Built-in box for two ways shower mixer.

+



I92KB

Set miscelatore doccia due vie da abbinare al box incasso.
Two ways shower mixer set to match with the built-in box.



RRBOX93

Box da incasso per miscelatore doccia tre vie.
Built-in box for three ways shower mixer.

+



I93KB

Set miscelatore doccia tre vie da abbinare al box incasso.
Three ways shower mixer set to match with the built-in box.



COLONNE DOCCIA - SHOWER COLUMN

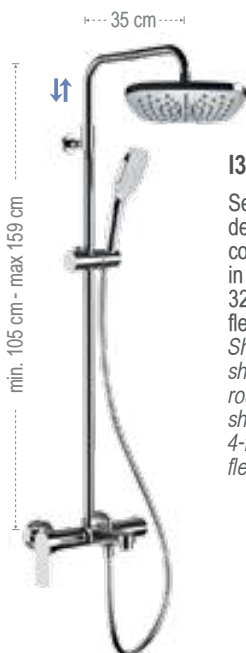

I34A8CPAD20

Set doccia composto da: miscelatore esterno con deviatore vasca/doccia, soffione in abs 20x20cm con angoli arrotondati 356AD20X, colonna doccia in ottone telescopica, altezza asta regolabile 329A, doccetta in abs con 4 funzioni 318CP, flessibile 150 cm.

Shower set including: exposed mixer with bath/shower diverter, abs 20x20 cm shower head with rounded corners 356AD20X, telescopic brass shower column, with height-adjustable rod 329A, 4-function abs hand shower 318CP, 150 cm flexible hose.



I37A8CPAD20

Set doccia composto da: miscelatore esterno con attacco superiore, soffione in abs 20x20cm con angoli arrotondati 356AD20X, colonna doccia in ottone telescopica, altezza asta regolabile, con deviatore 330A, doccetta in abs con 4 funzioni 318CP, flessibile 150 cm.

Shower mixer with 3/4" upper connection, telescopic shower column with diverter, ABS handshower 4 functions antilimestone (button to change the jets), 150 cm flexible hose and ABS shower head 20x20 cm, squared with rounded corners, with antilimestone silicon jets.



WELLNESS

**I09S07AD20**

Set doccia composto da: miscelatore a incasso con deviatore, soffione in abs 20x20cm con angoli arrotondati 356AD20X, braccio in ottone 30 cm, saliscendi tondo 315L, presa acqua a muro, doccetta in abs con 4 funzioni 318CP, flessibile 150 cm.

Shower set including: built-in mixer with diverter, abs 20x20 cm shower head with rounded corners 356AD20X, brass arm 30 cm, round sliding rail 315L, wall water connection, 4-function abs hand shower 318CP, 150 cm flexible hose.

**I09S08AD20**

Set doccia composto da: miscelatore a incasso con deviatore, soffione in abs 20x20cm con angoli arrotondati 356AD20X, braccio in ottone 30 cm, presa acqua a muro con supporto doccetta, doccetta in abs con 4 funzioni 318CP, flessibile 150 cm.

Shower set including: built-in mixer with diverter, abs 20x20 cm shower head with rounded corners 356AD20X, brass arm 30 cm, wall water connection with shower holder, 4-function abs hand shower 318CP, 150 cm flexible hose.



Set doccia composto da: miscelatore a incasso con deviatore, soffione in acciaio inox con angoli arrotondati 357UFD20X, braccio in ottone 30 cm, saliscendi tondo 315L, presa acqua a muro, doccetta in abs con 4 funzioni 318CP, flessibile 150 cm.

Shower set including: built-in mixer with diverter, stainless steel shower head with rounded corners 357UFD20X, brass arm 30 cm, round sliding rail 315L, wall water connection, 4-function abs hand shower 318CP, 150 cm flexible hose.



Set doccia composto da: miscelatore a incasso con deviatore, soffione in acciaio inox con angoli arrotondati 357UFD20X, braccio in ottone 30 cm, presa acqua a muro con supporto doccetta, doccetta in abs con 4 funzioni 318CP, flessibile 150 cm.

Shower set including: built-in mixer with diverter, stainless steel shower head with rounded corners 357UFD20X, brass arm 30 cm, wall water connection with shower holder, 4-function abs hand shower 318CP, 150 cm flexible hose.

**I09S07UFD20**

Con soffione da 20x20 cm *With shower head 20x20 cm*

I09S07UFD25

Con soffione da 25x25 cm *With shower head 25x25 cm*

I09S07UFD30

Con soffione da 30x30 cm *With shower head 30x30 cm*

I09S08UFD20

Con soffione da 20x20 cm *With shower head 20x20 cm*

I09S08UFD25

Con soffione da 25x25 cm *With shower head 25x25 cm*

I09S08UFD30

Con soffione da 30x30 cm *With shower head 30x30 cm*

CON OPZIONI DI FINITURA



WITH FINISHING OPTIONS

**I09S070**

Set doccia composto da: miscelatore a incasso con deviatore, soffione in ottone 20x20cm 359SSX, braccio in ottone 30 cm, saliscendi in ottone 317G, presa acqua a muro, doccetta quadrata in ottone a 1 funzione 317SS, flessibile 150 cm.

Shower set including: built-in mixer with diverter, brass shower head 20x20cm 359SSX, brass arm 30 cm, brass sliding rail 317G, wall water connection, 1-function brass square hand shower 317SS, 150 cm flexible hose.

**I09S080**

Set doccia composto da: miscelatore a incasso con deviatore, soffione in ottone 20x20cm 359SSX, braccio in ottone 30 cm, presa acqua a muro con supporto doccetta, doccetta quadrata in ottone a 1 funzione 317SS, flessibile 150 cm.

Shower set including: built-in mixer with diverter, brass shower head 20x20cm 359SSX, brass arm 30 cm, wall water connection with shower holder, 1-function brass square hand shower 317SS, 150 cm flexible hose.





CUCINA - KITCHEN MIXERS



I72
Miscelatore monocomando monoforo 90°, con canna alta a "U" girevole.
Single-lever sink mixer 90°, high "U" swivel spout.



I42B
Miscelatore monocomando per lavello, con bocca alta girevole.
Single-lever one-hole sink mixer, with high swivel spout, Infinity series.



I41
Miscelatore monocomando per lavello a muro, canna dritta.
Single-lever wall mounted sink mixer, straight spout.



I84
Miscelatore monocomando per lavello, con canna alta girevole e sistema di doccetta monofunzione estraibile.
Single-lever sink mixer with high swivel spout and single-function system pull-out hand shower.



I84DJ
Miscelatore monocomando per lavello, con canna alta girevole e doccetta estraibile a due funzioni.
Single-lever sink mixer with high swivel spout and 2-functions pull-out hand shower.

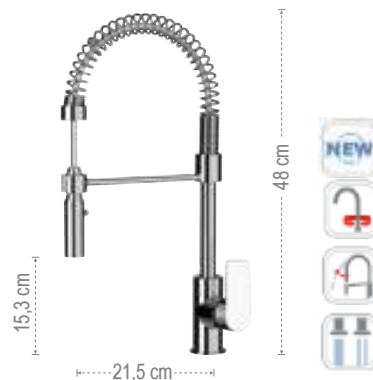

I77E
Miscelatore monocomando lavello a molla con doccetta estraibile dal supporto ed orientabile a due funzioni e cartuccia Ø 35.
Spring single-lever sink mixer with detachable and adjustable 2 functions handshower and Ø 35 mm cartridge.



ACQUA PURIFICATA
PURIFIED WATER MIXERS



I79DW
Miscelatore monocomando monoforo 90° per lavello, con bocca alta girevole ed orientabile, tipo lusso, modello sottofinestra.
Single-lever one-hole sink mixer, with high swivel and orientable spout, luxury type, under window type.



IT72
Miscelatore monocomando lavello, monoforo 90° con canna alta ad "U" dotata di tecnologia Touch-Me con leva laterale e bocca girevole. Dotato di cartuccia Ø35.
Single-lever sink mixer 90°, high "U" spout equipped with Touch-Me system with side lever and swivel spout. Equipped with Ø35 cartridge.



ABSOLUTE

ENERGY

VANITY

INFINITY

DREAM

CLASS LINE

CLASS LINE ECO

WINNER

WINNER ECO

DREAM

DREAM



Dream è l'espressione di un design chiaro e pulito, attento ai dettagli che fanno la differenza tra un prodotto normale ed uno di successo. Gli amanti dei particolari noteranno sicuramente che il corpo è sviluppato da una forma ellittica che sale verso l'alto con uno sforno esterno; in questo modo abbiamo eliminato esteticamente il raggio di giunzione tra corpo e bocca. Dream in sostanza è un sogno, il sogno di avere una rubinetteria dal design raffinato ad un costo ragionevole. La serie è dotata di cartuccia a dischi ceramici Ø 35 mm.

Dream is the expression of a clear and clean design, attentive to the details that make the difference between a normal product and a successful one. Lovers of details can definitely notice that the body is developed on an elliptically shape going upward with an external mould shape, thus aesthetically removing the junction radius between body and spout. Dream is essentially a dream, the dream to have refined design faucets at a reasonable price. The series is equipped with a Ø 35 mm ceramic disc cartridge



ABSOLUTE

ENERGY

VANITY

INFINITY

DREAM

CLASS LINE

CLASS LINE ECO

WINNER

WINNER ECO



NO nero opaco
matt black

BO bianco opaco
matt white

DREAM

OPZIONI DI FINITURA

Questa collezione di rubinetteria è disponibile con diverse opzioni di finitura, scegli il colore perfetto per il tuo progetto di arredo!

Rispondendo alle esigenze stilistiche dei progetti più ambiziosi, Remer Rubinetterie ha selezionato colori alternativi, oltre al cromato, studiati per arricchire, personalizzare e differenziare gli interni di bagno e cucina.

[Per confermare la propria scelta, aggiungere il codice della finitura al termine del codice prodotto durante la fase di acquisto.]

DREAM

FINISHING OPTIONS

This faucet collection is available with different finishing options, choose the perfect color to customize your interior!

Responding to the stylistic needs of the most ambitious designs, Remer Rubinetterie selected alternative colors, in addition to chrome, to enrich, customize and differentiate bathroom and kitchen interiors.

[To confirm your choice, add the finishing code at the end of the item code during the purchase phase.]



ABSOLUTE

ENERGY

VANITY

INFINITY

DREAM

CLASS LINE

CLASS LINE ECO

WINNER

WINNER ECO

CR

cromo
chrome

CR

FIN 1

nero opaco
matt black

NO

bianco opaco
matt white

BO

FIN 2

oro lucido
shiny gold

DO

LAVABI - WASHBASIN MIXERS

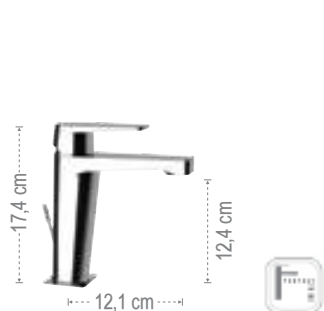

Miscelatore monocomando lavabo.
Single-lever basin mixer.

D10

con scarico.
with pop-up waste.



D11

senza scarico.
without waste.



D12

senza scarico e senza foro sul corpo.
without waste and without body hole.



D15

Miscelatore monocomando a incasso per lavabo, con piastra in ottone.
Single-lever built-in basin mixer, with wall flange in brass.



D15L

Lunghezza bocca 23 cm.
Spout lenght 23 cm.



Miscelatore monocomando lavabo alto L.
L high single-lever basin mixer.

D10L

con scarico click-clack con troppopieno.
with click-clack waste and overflow



D11L

senza scarico.
without waste.



D72C

Miscelatore monocomando lavabo senza scarico, con canna corta a "U" girevole, tipo lusso.
Single-lever basin mixer without waste, with short "U" swivel spout, luxury type.



D57

Miscelatore monocomando lavabo due fori senza scarico.
Two holes single-lever washbasin mixer without waste.



LAVABO BOX INCASSO - BUILT-IN BOX WASHBASIN MIXER



D15KB

Miscelatore monocomando a incasso per lavabo, con piastra in ottone, bocca lunghezza 18 cm, da abbinare al box incasso.
Single-lever built-in basin mixer, with wall flange in brass, spout lenght 18 cm, to match with the built-in box.



D15LKB

Lunghezza bocca 23 cm.
Spout lenght 23 cm.



RRBOX15

Box da incasso per miscelatore monocomando a incasso per lavabo.
Built-in box for single-lever built-in basin mixer.

BIDET - BIDET MIXERS



Miscelatore monocomando bidet.
Single-lever bidet mixer.

D20
con scarico.
with pop-up waste.



D21
senza scarico.
without waste.



Miscelatore incasso per shut-off con supporto doccia/presa acqua integrato, attacco conico da 1/2", tutto in ottone.
Built-in shower mixer with integrated shower holder/water punch on flange all in brass, with 1/2 connection.

D65W
con doccetta shut-off, flessibile doccia cm 120.
including shut-off and flexible cm 120.



D65B
senza kit doccia.
without shower kit.



D60
Miscelatore incasso per shut-off comprensivo di: doccetta shut-off, supporto doccia-presa acqua su piastra in ottone e flessibile doccia cm 120.
Built-in shower mixer set including: shut-off, shower holder water punch on flange all in brass and shower flexible cm 120.



ABSOLUTE

ENERGY

VANITY

INFINITY

DREAM

VASCA - BATH MIXERS



Miscelatore vasca.
Wall mounted bath mixer.

D028CP
con flessibile cm 150 e doccetta a 4 funzioni con getti in silicone anticalcare.
with flexible cm 150 and 4 functions antilimestone handshower with silicon jets.



D05
senza kit doccia.
without shower kit.



D078CP
Miscelatore monocomando bordo vasca con deviatore a leva integrato nella bocca minimale e doccetta in ABS cromato a 4 funzioni.
Single lever deck bath mixer with lever diverter integrated on the minimal spout and pull-out 4 functions chrome plated ABS handshower.



D07UF8CP
Miscelatore monocomando bordo vasca con deviatore integrato nel miscelatore, bocca a cascata e doccetta estraibile in ABS cromato a 4 funzioni.
Single lever deck bath mixer with diverter integrated on the mixer, with waterfall spout and pull-out 4 functions chrome plated ABS handshower.



CLASS LINE

CLASS LINE ECO

WINNER

WINNER ECO

DOCCE - SHOWER MIXERS



Miscelatore doccia.
Exposed shower mixer.

D388CP

con flessibile cm 150 e doccetta a 4 funzioni con getti in silicone anticalcare.
with flexible hose cm 150 and 4 functions antilimestone handshower with silicon jets.



D33

senza kit doccia.
without shower kit.



315L318CP

Saliscendi minimale con doccetta cromata minimale a 4 funzioni con getti in silicone, anticalcare e flessibile in ottone cromato 150 cm.

Minimal sliding rail with minimal handshower 4 functions, antilimestone and brass flexible hose 150 cm.



INCASSI DOCCIA - AND BUILT-IN SHOWER MIXERS



D30

Miscelatore monocomando a incasso per doccia completo.
Complete single lever built-in shower mixer.



D09

Miscelatore monocomando a incasso con deviatore per vasca/doccia completo.
Complete single lever built-in bath/shower mixer with diverter.



N30B

Solo parte interna miscelatore monocomando incasso doccia.
Single-lever shower mixer (only built-in components).



D30E

Solo parte esterna miscelatore monocomando incasso doccia.
Single-lever shower mixer (only external components).



N09B

Solo parte interna miscelatore monocomando incasso vasca/doccia con deviatore.
Single-lever bath/shower mixer with diverter (only built-in components).



D09E

Solo parte esterna miscelatore monocomando incasso vasca/doccia con deviatore.
Single-lever bath/shower mixer with diverter (only external components).



D92

Miscelatore monocomando per doccia, con deviatore a due posizioni (due uscite ed una entrata) su piastra unica.
Single-lever shower mixer with 2 positions diverter (2 outlets and 1 inlet) on single flange.



D93

Miscelatore monocomando per doccia con deviatore a tre vie (una entrata e tre uscite) su unica piastra.
Single lever built-in shower mixer with three ways diverter (1 inlet and 3 outlets) on single flange.



BOX INCASSO - BUILT-IN BOX MIXERS



RRBOX
Box da incasso per miscelatore doccia con deviatore.
Built-in box for shower mixer with diverter.



D30KB
Set miscelatore doccia da abbinare al box incasso.
Shower mixer set to match with the built-in box.

OPPURE
OR



D09KB
Set miscelatore doccia con deviatore da abbinare al box incasso.
Shower mixer set with diverter to match with the built-in box.



RRBOX92
Box da incasso per miscelatore doccia due vie.
Built-in box for two ways shower mixer.



D92KB
Set miscelatore doccia due vie da abbinare al box incasso.
Two ways shower mixer set to match with the built-in box.



RRBOX93
Box da incasso per miscelatore doccia tre vie.
Built-in box for three ways shower mixer.



D93KB
Set miscelatore doccia tre vie da abbinare al box incasso.
Three ways shower mixer set to match with the built-in box.



COLONNE DOCCIA - SHOWER COLUMNS



min. 105 cm - max. 159 cm

Set doccia composto da: miscelatore esterno con deviatore vasca/doccia, soffione in acciaio inox con angoli arrotondati 357UFD20X, colonna doccia in ottone telescopica, altezza asta regolabile 329A, doccetta in abs con 4 funzioni 318CP, flessibile 150 cm.
Shower set including: exposed mixer with bath/shower diverter, stainless steel 20x20 cm shower head with rounded corners 357UFD20X, telescopic brass shower column, with height-adjustable rod 329A, 4-function abs hand shower 318CP, 150 cm flexible hose.

D34A8CPUFD20
con soffione da 20x20 cm
with shower head 20x20

D34A8CPUFD25
con soffione da 25x25 cm
with shower head 25x25 cm

D34A8CPUFD30
con soffione da 30x30 cm
with shower head 30x30 cm

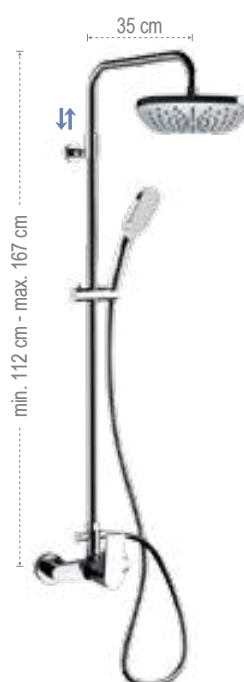

min. 112 cm - max. 167 cm

D37A8CPAD20
Set doccia composto da: miscelatore esterno con attacco superiore, soffione in abs 20x20cm con angoli arrotondati 356AD20X, colonna doccia in ottone telescopica, altezza asta regolabile, con deviatore 330A, doccetta in abs con 4 funzioni 318CP, flessibile 150 cm.
Shower set including: exposed mixer with upper connection, abs 20x20 cm shower head with rounded corners 356AD20X, telescopic brass shower column, with height-adjustable rod, with diverter 330A, 4-function abs hand shower 318CP, 150 cm flexible hose.



ABSOLUTE

ENERGY

VANITY

INFINITY

DREAM

CLASS LINE

CLASS LINE ECO

WINNER

WINNER ECO

**D09S018CPAD20**

Set doccia composto da: miscelatore a incasso con deviatore, soffione in abs 20x20cm con angoli arrotondati 356AD20X, braccio in ottone 30 cm, saliscendi tondo 315R, presa acqua a muro, doccetta in abs con 4 funzioni 318CP, flessibile 150 cm.

Shower set including: built-in mixer with diverter, abs 20x20 cm shower head with rounded corners 356AD20X, brass arm 30 cm, round sliding rail 315R, wall water connection, 4-function abs hand shower 318CP, 150 cm flexible hose.

**D09S028CPAD20**

Set doccia composto da: miscelatore a incasso con deviatore, soffione in abs 20x20cm con angoli arrotondati 356AD20X, braccio in ottone 30 cm, presa acqua a muro con supporto doccetta, doccetta in abs con 4 funzioni 318CP, flessibile 150 cm.

Shower set including: built-in mixer with diverter, abs 20x20 cm shower head with rounded corners 356AD20X, brass arm 30 cm, wall water connection with shower holder, wall water connection with shower holder, 4-function abs hand shower 318CP, 150 cm flexible hose.



Set doccia composto da: miscelatore a incasso con deviatore, soffione in acciaio inox 20x20cm con angoli arrotondati 357UFD20X, braccio in ottone 30 cm, saliscendi tondo 315R, presa acqua a muro, doccetta in abs con 4 funzioni 318CP, flessibile 150 cm.

Shower set including: built-in mixer with diverter, stainless steel 20x20 cm shower head with rounded corners 357UFD20X, brass arm 30 cm, round sliding rail 315R, wall water connection, 4-function abs hand shower 318CP, 150 cm flexible hose.



Set doccia composto da: miscelatore a incasso con deviatore, soffione in acciaio inox con angoli arrotondati 357UFD20X, braccio in ottone 30 cm, presa acqua a muro con supporto doccetta, doccetta in abs con 4 funzioni 318CP, flessibile 150 cm.

Shower set including: built-in mixer with diverter, stainless steel shower head with rounded corners 357UFD20X, brass arm 30 cm, wall water connection with shower holder, wall water connection with shower holder, 4-function abs hand shower 318CP, 150 cm flexible hose.

**D09S018CPUFD20**

con soffione da 20x20 cm e braccio a parete 30 cm.
with shower head 20x20 cm and wall arm 30 cm.

D09S018CPUFD25

con soffione da 25x25 cm e braccio a parete 30 cm.
with shower head 25x25 cm and wall arm 30 cm.

D09S018CPUFD30

con soffione da 30x30 cm e braccio a parete 30 cm.
with shower head 30x30 cm and wall arm 30 cm.

D09S018CPUFD40

con soffione da 40x40 cm e braccio a parete da 40 cm.
with shower head 40x40 cm and wall arm 40 cm.

D09S028CPUFD20

con soffione da 20x20 cm e braccio a parete 30 cm.
with shower head 20x20 cm and wall arm 30 cm.

D09S028CPUFD25

con soffione da 25x25 cm e braccio a parete 30 cm.
with shower head 25x25 cm and wall arm 30 cm.

D09S028CPUFD30

con soffione da 30x30 cm e braccio a parete 30 cm.
with shower head 30x30 cm and wall arm 30 cm.

D09S028CPUFD40

con soffione da 40x40 cm e braccio a parete da 40 cm.
with shower head 40x40 cm and wall arm 40 cm.

CUCINA - KITCHEN MIXERS

**D72**

Miscelatore monocomando monoforo 90°, con canna alta a "U" girevole.
Single-lever sink mixer 90°, high "U" swivel spout.

**D42B**

Miscelatore monocomando per lavello, con bocca alta girevole.
Single-lever one-hole sink mixer, with high swivel spout.

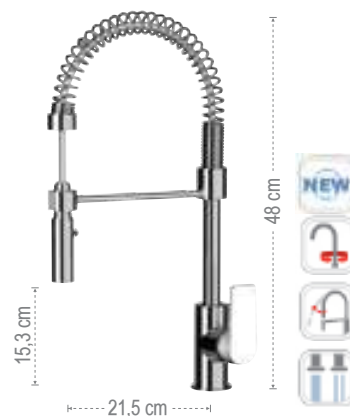
**D77E**

Miscelatore monocomando lavello a molla con doccetta estraibile dal supporto ed orientabile a due funzioni e cartuccia Ø 35.
Spring single-lever sink mixer with detachable and adjustable 2-functions handshower and Ø 35 mm cartridge.

**D84**

Miscelatore monocomando per lavello, con canna alta girevole e sistema di doccetta monofunzione estraibile.
Single-lever sink mixer with high swivel spout and single-function system pull-out hand shower.

**D84DJ**

Miscelatore monocomando per lavello, con canna alta girevole e doccetta estraibile a due funzioni.
Single-lever sink mixer with high swivel spout and 2-functions pull-out hand shower.

**D533**

Miscelatore lavello monocomando con flessibile nero rivestito con molla "fine design" girevole 360°, con doccetta estraibile di supporto ed orientabile a due funzioni e cartuccia Ø 35.
Single-lever mixer with black flexible hose coated with "fine design" spring, 360° swivel, with detachable and adjustable 2 functions handshower and Ø 35 mm cartridge.

ACQUA PURIFICATA
PURIFIED WATER MIXERS**D79DW**

Miscelatore lavello a tre vie di ingresso con bocca girevole e due vie d'uscita completamente indipendenti, con selezione acqua potabile tramite la leva.
Three ways inlet single lever sink mixer, with swivel spout and two fully independent outlets, with selection for drinking water directly from the lever.



TOUCH-ME

**DT72**

Miscelatore monocomando lavello, monoforo 90° con canna alta ad "U" dotata di tecnologia Touch-Me con leva laterale e bocca girevole. Dotato di cartuccia Ø35.
Single-lever sink mixer 90°, high "U" spout equipped with Touch-Me system with side lever and swivel spout. Equipped with Ø35 cartridge.



ABSOLUTE

ENERGY

VANITY

INFINITY

DREAM

CLASS LINE

CLASS LINE ECO

WINNER

WINNER ECO

CLASS LINE

CLASS LINE



Class line è una serie di miscelatori dedicata da Remer Rubinetterie a una Clientela in cerca di un design moderno e del comfort dei miscelatori di tipo classico. Il design della serie gioca sul parallelismo tra leva e bocca di erogazione rendendo le superfici completamente piatte e riflettenti per poi fonderle con raggiature più morbide, in una perfetta unione tra tondo e quadro. Una serie completa che mette in evidenza caratteristiche tecniche e di design esemplari. La serie è dotata di cartuccia a dischi ceramici Ø 35 mm

Class line is a series of mixers dedicated by Remer to customers target to looking for a modern design line and the comforts of the classic mixers. The design of the series plays on parallelism between the lever and the outlet spout, making the surfaces completely flat, reflective and then joining them with softer radius, in a perfect matching between round and squared, at a reasonable price. A complete set of faucets that highlights technical and design features. The series is equipped with a Ø 35 mm ceramic disc cartridge



ABSOLUTE

ENERGY

VANITY

INFINITY

DREAM

CLASS LINE

CLASS LINE ECO

WINNER

WINNER ECO



CLASS LINE

OPZIONI DI FINITURA

Questa collezione di rubinetteria è disponibile con diverse opzioni di finitura, scegli il colore perfetto per il tuo progetto di arredo!

Rispondendo alle esigenze stilistiche dei progetti più ambiziosi, Remer Rubinetterie ha selezionato colori alternativi, oltre al cromato, studiati per arricchire, personalizzare e differenziare gli interni di bagno e cucina.

[Per confermare la propria scelta, aggiungere il codice della finitura al termine del codice prodotto durante la fase di acquisto.]

CLASS LINE

FINISHING OPTIONS

This faucet collection is available with different finishing options, choose the perfect color to customize your interior!

Responding to the stylistic needs of the most ambitious designs, Remer Rubinetterie selected alternative colors, in addition to chrome, to enrich, customize and differentiate bathroom and kitchen interiors.

[To confirm your choice, add the finishing code at the end of the item code during the purchase phase.]



NP nichel spazzolato
brushed nickel

ABSOLUTE

ENERGY

VANITY

INFINITY

DREAM

CLASS LINE

CLASS LINE ECO

WINNER

WINNER ECO

CR



cromo
chrome

CR

FIN 1



nero opaco
matt black

NO



bianco opaco
matt white

BO



nichel spazzolato
brushed nickel

NP

LAVABI - WASHBASIN MIXERS



Miscelatore monocomando lavabo.
Single-lever basin mixer.

L10

con scarico.
with pop-up waste.



L10P

con scarico in plastica.
with plastic waste.



L11

senza scarico.
without waste.



L12

senza scarico e
senza foro sul corpo.
without waste and
without body hole.

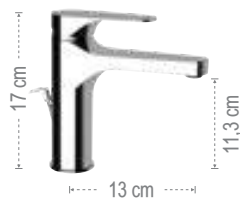

Miscelatore monocomando lavabo alto L.
L high single lever basin mixer.

L10L

con scarico.
with pop-up waste.



L11L

senza scarico.
without waste.



L12L

senza scarico e
senza foro sul corpo.
without waste and
without body hole.

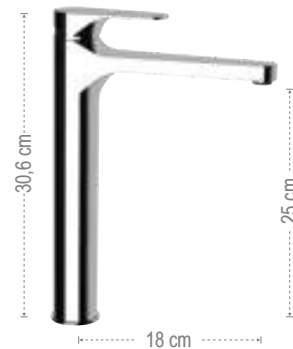

Miscelatore monocomando lavabo alto XL.
XL high basin mixer.

L10LXL

con scarico click-clack
con troppopieno.
with click-clack waste
and overflow



L11LXL

senza scarico.
without waste.



L72C

Miscelatore monocomando lavabo
senza scarico, con canna corta a
"U" girevole, tipo lusso.
Single-lever basin mixer without
waste, with short "U" swivel
spout, luxury type.



L57

Miscelatore monocomando
lavello due fori senza scarico.
Two holes single-lever mixer
without waste.



L15

Miscelatore monocomando a
incasso per lavabo, con piastra
rettangolare in ottone.
Single-lever built-in basin mixer,
with rectangular wall flange in brass.



91LD

Bocca incasso con deviatore
integrato.
Built-in spout with diverter.



91L

Bocca incasso.
Built-in spout.



L18

Miscelatore monocomando
lavabo da terra con scarico
click-clack.
Single-lever mixer for floor
mounting with click-clack waste.



LAVABO BOX INCASSO - BUILT-IN BOX WASHBASIN MIXER



L15KB
Miscelatore monocomando a incasso per lavabo, con piastra in ottone, da abbinare al box incasso.
Single-lever built-in basin mixer, with wall flange in brass, to match with the built-in box.



+



RRBOX15
Box da incasso per miscelatore monocomando a incasso per lavabo.
Built-in box for single-lever built-in basin mixer.

L15LKB
Lunghezza bocca 23 cm.
Spout length 23 cm.



BIDET - BIDET MIXERS



Miscelatore monocomando bidet.
Single-lever bidet mixer.

L20
con scarico.
with pop-up waste.



L20P
con scarico in plastica.
with plastic waste.



L21
senza scarico.
without waste.



Miscelatore incasso per shut-off con supporto doccia/presa acqua integrato, attacco conico da 1/2", tutto in ottone.
Built-in shower mixer with integrated shower holder/water punch on flange all in brass, with 1/2 connection.

L65W
con doccetta shut-off e flessibile cm 120.
with shut-off and flexible hose cm 120.



L65B
senza kit doccia.
without shower kit.



Miscelatore monocomando esterno doccia, interasse 100 mm.
Wall mounted single lever shower mixer, interaxis 100 mm.

LC31DP
con doccetta shut-off e flessibile cm 120.
with shut-off and flexible hose cm 120.



LC31
senza kit doccia.
without shower kit.



L63
Miscelatore incasso per shut-off.
Built-in shut-off mixer.



L60W
Miscelatore incasso per shut-off comprensivo di: doccetta shut-off, supporto doccia/presa acqua su piastra in ottone e flessibile cm 120.
Built-in shower mixer set including: shut-off, shower holder water punch on flange all in brass and flexible hose cm 120.



L10SHW
Miscelatore monocomando lavabo con doccetta shut-off e scarico click-clack con troppo pieno.
Single-lever basin mixer with handshower shut-off and click-clack waste with overflow.



ABSOLUTE

ENERGY

VANITY

INFINITY

DREAM

CLASS LINE

CLASS LINE ECO

WINNER

WINNER ECO

VASCA - BATH MIXERS



Miscelatore vasca con deviatore integrato.
Wall mounted bath mixer with integrated diverter.

L02

con flessibile cm 150 e doccetta a 4 funzioni con getti anticalcare e supporto snodato.
with flexible hose cm 150 and 4 functions antilimestone handshower and swivel shower holder.



L05

senza kit doccia.
without shower kit.



Miscelatore lavabo/vasca con canna fusa lunghezza 30 cm con deviatore integrato.
Wall mounted basin/bath single lever mixer with long casted spout length 30 cm and integrated diverter.

L49

con flessibile cm 150 e doccetta in ABS a 4 funzioni con anticalcare e supporto snodato.
with brass flexible hose cm 150 and 4 functions ABS antilimestone handshower and swivel shower holder.



L46

senza kit doccia.
without shower kit.



L07

Miscelatore monocomando bordo vasca con deviatore a leva integrato nella bocca minimale in ottone e doccetta cromata estraibile a 4 funzioni.
Single lever deck bath mixer with lever diverter integrated on the spout, with minimal brass spout and 4 functions ABS handshower.



Miscelatore monocomando per vasca.
Single lever bath mixer with diverter.

L03

con flessibile cm 150 e doccetta a 4 funzioni con getti anticalcare e supporto snodato.
with flexible hose cm 150 and 4 functions antilimestone handshower and swivel shower holder.

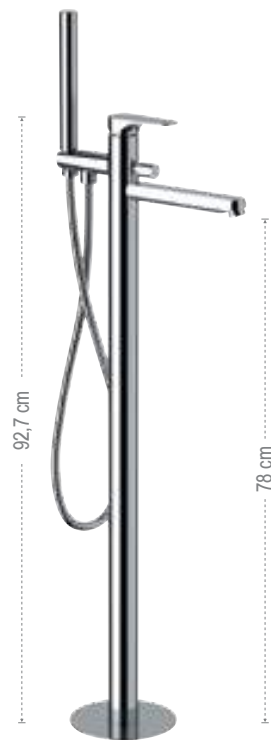

92,7 cm

78 cm

23 cm

L08

Miscelatore bordo vasca da pavimento, con deviatore e kit doccia in ottone doccetta ad 1 funzione e flessibile 150 cm, senza scarico.
Single-lever bath mixer floor mounting, with diverter and brass shower kit, 1 function handshower and flexible hose 150 cm, without waste.



L07UF

Miscelatore monocomando bordo vasca con deviatore integrato nel miscelatore, bocca a cascata e doccetta estraibile a 4 funzioni in ABS.
Single lever deck bath mixer with diverter integrated on the mixer, with waterfall spout and pull-out 4 functions ABS handshower.



L06

Miscelatore monocomando bordo vasca con deviatore, bocca con effetto multigetto e doccetta in ABS estraibile a 4 funzioni.
Single lever deck bath/shower mixer with diverter, spout with multijets effect and pull-out ABS handshower 4 functions.



INCASSI DOCCIA - BUILT-IN SHOWER MIXERS



L30

Miscelatore monocomando a incasso per doccia completo.
Complete single lever built-in shower mixer.



N30B

Solo parte interna miscelatore monocomando incasso doccia.
Single-lever shower mixer (only built-in components).



L30E

Solo parte esterna miscelatore monocomando incasso doccia.
Single-lever shower mixer (only external components).



L09

Miscelatore monocomando a incasso con deviatore per vasca/doccia completo.
Complete single lever built-in bath/shower mixer with diverter.



N09B

Solo parte interna miscelatore monocomando incasso vasca/doccia con deviatore.
Single-lever 36,5 bath/shower mixer with diverter (only built-in components).



L09E

Solo parte esterna miscelatore monocomando incasso vasca/doccia con deviatore.
Single-lever bath/shower mixer with diverter (only external components).



L30L

Monocomando doccia incasso con piastra lusso Class Line completo.
Complete built-in shower mixer with deluxe Class Line plate.



N30B

Solo parte interna miscelatore monocomando incasso doccia.
Single-lever shower mixer (only built-in components).



L30LE

Solo parte esterna miscelatore monocomando incasso doccia, piastra lusso Class Line.
Single-lever shower mixer (only external components), deluxe Class Line plate.



L09L

Monocomando vasca/doccia incasso con deviatore con piastra lusso Class Line completo.
Complete built-in bath/shower mixer with diverter with deluxe Class Line Plate.



N09B

Solo parte interna miscelatore monocomando incasso vasca/doccia con deviatore.
Single-lever bath/shower mixer with diverter (only built-in components).



L09LE

Solo parte esterna miscelatore monocomando incasso vasca/doccia con deviatore, piastra lusso Class Line.36,5
Single-lever bath/shower mixer with diverter (only external components), deluxe Class Line plate.



L92

Miscelatore monocomando per doccia, con deviatore a due posizioni (due uscite ed una entrata) su piastra unica.
Single-lever shower mixer with 2 positions diverter (2 outlets and 1 inlet) on single flange.



L93

Miscelatore monocomando per doccia con deviatore a tre vie (una entrata e tre uscite) su unica piastra.
Single lever built-in shower mixer with three ways diverter (1 inlet and 3 outlets) on single flange.



L94

Miscelatore monocomando per doccia, con deviatore a 4 posizioni (4 uscite ed 1 entrata) su piastra unica.
Single-lever shower mixer with 4 positions diverter (4 outlets and 1 inlet,) on single flange.



L95

Miscelatore monocomando per doccia, con deviatore a 5 posizioni (5 uscite ed 1 entrata) su piastra unica.
Single-lever shower mixer with 5 positions diverter (5 outlets and 1 inlet,) on single flange.



ABSOLUTE

ENERGY

VANITY

INFINITY

DREAM

CLASS LINE

CLASS LINE ECO

WINNER

WINNER ECO

DOCCE E SALISCENDI - SHOWER MIXERS AND SLIDING RAIL SETS



317M319MO

Saliscendi minimale con doccetta con idromassaggio a 4 funzioni.
Minimal sliding rail set with hydromassage and 4 function handshower.



315L318MP

Saliscendi minimale con doccetta a 4 funzioni con pulsante per il cambio getti, anticalcare.
Minimal sliding rail set with 4 function handshower, with button to change jets, antilimestone.



Miscelatore doccia esterno.
Exposed shower mixer.

L39

con flessibile cm 150 e doccetta a 4 funzioni con getti in silicone anticalcare e supporto snodato.
with flexible cm 150 and 4 functions antilimestone handshower with silicon jets and swivel shower holder.



L33

Miscelatore monocomando doccia esterno con leva frontale, senza kit doccia, con attacco 1/2".
Wall mounted single-lever shower mixer with frontal lever, without shower kit, 1/2" connection.



L31

senza kit doccia.
without shower kit.



BOX INCASSO - BUILT-IN BOX MIXERS



RRBOX

Box da incasso per miscelatore doccia con deviatore.
Built-in box for shower mixer with diverter.

+



L30KB

Set miscelatore doccia da abbinare al box incasso.
Shower mixer set to match with the built-in box.

OPPURE
OR



L09KB

Set miscelatore doccia con deviatore da abbinare al box incasso.
Shower mixer set with diverter to match with the built-in box.



RRBOX92

Box da incasso per miscelatore doccia due vie.
Built-in box for two ways shower mixer.

+



L92KB

Set miscelatore doccia due vie da abbinare al box incasso.
Two ways shower mixer set to match with the built-in box.



RRBOX93

Box da incasso per miscelatore doccia tre vie.
Built-in box for three ways shower mixer.

+



L93KB

Set miscelatore doccia tre vie da abbinare al box incasso.
Three ways shower mixer set to match with the built-in box.



COLONNE DOCCIA - SHOWER COLUMN



min. 105 cm - max. 159 cm

Miscelatore vasca/doccia a 3 vie con deviatore integrato, colonna doccia telescopica, doccetta in ABS anticalcare 4 funzioni, flessibile 150 cm e soffione in ABS con getti anticalcare.
3 ways bath/shower mixer with integrated diverter, telescopic shower column, ABS handshower with antilimestone jets 4 functions, 150 cm flexible hose and ABS shower head, with antilimestone jets.

L34A8MPMD20
 con soffione Ø 20 cm.
with shower head Ø 20 cm.

L34A8MPMD25
 con soffione Ø 25 cm.
with shower head Ø 25 cm.

L34A8MPMD30
 con soffione Ø 30 cm.
with shower head Ø 30 cm.

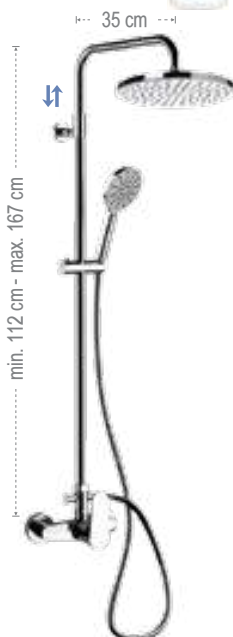

min. 112 cm - max. 167 cm

Miscelatore doccia con attacco da 3/4", colonna doccia telescopica con deviatore, doccetta in ABS anticalcare 4 funzioni, flessibile 150 cm e soffione ABS con getti anticalcare.
Shower mixer with upper 3/4" connection, telescopic shower column with diverter, ABS handshower with antilimestone jets 4 functions, 150 cm flexible hose and ABS shower head with antilimestone jets.

L37A8MPMD20
 con soffione Ø 20 cm.
with shower head Ø 20 cm.

L37A8MPMD25
 con soffione Ø 25 cm.
with shower head Ø 25 cm.

L37A8MPMD30
 con soffione Ø 30 cm.
with shower head Ø 30 cm.



WELLNESS



Set doccia composto da: miscelatore a incasso con deviatore, soffione in abs 356MD20X, braccio in ottone 30 cm, saliscendi tondo 315L, presa acqua a muro, doccetta in abs con 4 funzioni 318MP, flessibile 150 cm.
Shower set including: built-in mixer with diverter, abs shower head 356MD20X, brass arm 30 cm, round sliding rail 315L, wall water connection, 4-function abs hand shower 318MP, 150 cm flexible hose.



L09S01MD20
 con soffione da Ø20 cm e braccio a parete 30 cm.
with shower head Ø20 cm and wall arm 30 cm.

L09S01MD25
 con soffione da Ø25 cm e braccio a parete 30 cm.
with shower head cm 25 cm and wall arm 30 cm.

L09S01MD30
 con soffione da Ø30 cm e braccio a parete 30 cm.
with shower head Ø30 cm and wall arm 30 cm.



Set doccia composto da: miscelatore a incasso con deviatore, soffione in abs Ø 20 cm 356MD20X, braccio in ottone 30 cm, presa acqua a muro con supporto doccetta, doccetta in abs con 4 funzioni 318MP, flessibile 150 cm.
Shower set including: built-in mixer with diverter, abs shower head 356MD20X, brass arm 30 cm, wall water connection with shower holder, 4-function abs hand shower 318MP, 150 cm flexible hose.



L09S02MD20
 con soffione da Ø20 cm e braccio a parete 30 cm.
with shower head Ø20 cm and wall arm 30 cm.

L09S02MD25
 con soffione da Ø25 cm e braccio a parete 30 cm.
with shower head Ø25 cm and wall arm 30 cm.

L09S02MD30
 con soffione da Ø30 cm e braccio a parete 30 cm.
with shower head Ø30 cm and wall arm 30 cm.



L09S01
 Set doccia composto da: miscelatore a incasso con deviatore, soffione in abs Ø 20 cm 356MD20X, braccio in ottone 30 cm, saliscendi minimale 317M, presa acqua a muro, doccetta in abs a 4 funzioni 319MO, flessibile 150 cm.
Shower set including: built-in mixer with diverter, abs Ø 20 cm shower head 356MD20X, brass arm 30 cm, minimal sliding rail 317M, wall water connection, 4-function abs hand shower 319MO, 150 cm flexible hose.



L09S02
 Set doccia composto da: miscelatore a incasso con deviatore, soffione in abs Ø 20 cm 356MD20X, braccio in ottone 30 cm, presa acqua a muro con supporto doccetta, doccetta in abs a 4 funzioni 319MO, flessibile 150 cm.
Shower set including: built-in mixer with diverter, abs Ø 20 cm shower head 356MD20X, brass arm 30 cm, wall water connection with shower holder, 4-function abs hand shower 319MO, 150 cm flexible hose.



ABSOLUTE

ENERGY

VANITY

INFINITY

DREAM

CLASS LINE

CLASS LINE ECO

WINNER

WINNER ECO



L84DJ

CUCINA - KITCHEN MIXERS



L72
Miscelatore monocomando monoforo 90°, con canna a "U" girevole.
Single-lever sink mixer 90°, high swivel "U" spout.



L77E
Miscelatore monocomando lavello a molla con doccetta estraibile dal supporto ed orientabile a due funzioni e cartuccia Ø 35.
Spring single-lever sink mixer with detachable and adjustable 2-functions handshower and Ø 35 mm cartridge.



L84
Miscelatore monocomando per lavello, con canna alta girevole e sistema di doccetta monofunzione estraibile.
Single-lever sink mixer with high swivel spout and single-function system pull-out hand shower.



L84DJ
Miscelatore monocomando per lavello, con canna alta girevole e doccetta estraibile a due funzioni.
Single-lever sink mixer with high swivel spout and 2-functions pull-out hand shower.



L42B
Miscelatore monocomando per lavello, con bocca alta girevole.
Single-lever one-hole sink mixer, with high swivel spout.



L42
Miscelatore monocomando per lavello, con bocca girevole tipo lusso.
Single-lever one-hole sink mixer, with luxury type swivel spout.



**L42U**

Miscelatore monocomando per lavello, con bocca girevole a "U".
Single-lever sink mixer, with "U" swivel spout.

**L42R**

Miscelatore monocomando monoforo 90° per lavello, con bocca alta girevole ed abbattibile tipo lusso, modello sottofinestra.
Single-lever one-hole sink mixer, with high spout, luxury type, under window type.

**L42C**

Miscelatore monocomando per lavello, con bocca corta girevole, tipo lusso a "C".
Single-lever one-hole sink mixer, with high swivel spout, shorter model, luxury type.

**L40**

Miscelatore monocomando per lavello, girevole.
Single-lever one-hole sink mixer with swivel spout.

**L41**

Miscelatore monocomando per lavello a muro, canna dritta.
Single-lever wall mounted sink mixer with straight spout.

**L43**

Miscelatore monocomando per lavello a muro, con leva frontale e bocca alta girevole.
Single-lever wall mounted sink mixer, with frontal lever and high swivel spout.

**L43B**

Miscelatore monocomando per lavello a muro, con leva frontale e bocca alta a "U" girevole.
Single-lever wall mounted sink mixer, with frontal lever and high "U" swivel spout.



ACQUA PURIFICATA PURIFIED WATER MIXERS

**L79DW**

Miscelatore lavello a tre vie di ingresso con bocca girevole e due vie d'uscita completamente indipendenti, con selezione acqua potabile tramite la leva.
Three ways inlet single lever sink mixer, with swivel spout and two fully independent outlets, with selection for drinking water directly from the lever.



TOUCH-ME

**LT72**

Miscelatore monocomando lavello, monoforo 90° con canna alta a "U" dotata di tecnologia Touch-Me con leva laterale e bocca girevole. Dotato di cartuccia Ø35.
Single-lever sink mixer 90°, high "U" spout equipped with Touch-Me system with side lever and swivel spout. Equipped with Ø35 cartridge.

**LT72U**

Miscelatore monocomando lavello, monoforo 90° con canna alta quadra a "U" dotata di tecnologia Touch-Me con leva laterale e bocca girevole. Dotato di cartuccia Ø35.
Single-lever sink mixer 90°, high squared "U" spout equipped with Touch-Me system with side lever and swivel spout. Equipped with Ø35 cartridge.



ABSOLUTE

ENERGY

VANITY

INFINITY

DREAM

CLASS LINE

CLASS LINE ECO

WINNER

WINNER ECO

CLASS LINE ECO



CLASS LINE ECO è una collezione di miscelatori dal design semplice e curato, creata per controllare e ridurre i consumi idrici ed energetici in casa. La combinazione di più tecnologie di risparmio permette infatti di limitare alla sola necessità sia il consumo di acqua che l'utilizzo di acqua calda, senza stravolgere le abitudini quotidiane. La serie è dotata di cartuccia ENERGY SAVING a dischi ceramici Ø 35 mm

CLASS LINE ECO is a collection of mixers with a simple and refined design, created to control and reduce the water and energy consumption in the house. The combination of different saving technologies limit to the actual need both the consumption of water and the use of hot water, without upsetting daily habits. The series is equipped with a Ø 35 mm ceramic disc ENERGY SAVING cartridge



LE10LXLLT6

WINNER ECO

WINNER

CLASS LINE ECO

CLASS LINE

DREAM

INFINITY

VANITY

ENERGY

ABSOLUTE



RISPARMIO IDRICO ED ENERGETICO
ENERGY AND WATER SAVING
 WATER SAVING

PROGRAMMA ECO
ECO PROGRAM



Design e tecnologia ambientale
Design and environmental technology

Il programma ECO nasce per il controllo dei consumi, per un reale risparmio sia economico che ambientale. CLASS LINE ECO combina diverse tecnologie di risparmio: cartuccia ENERGY SAVING, aeratore WATER SAVING, anello ANTISCALDING, leva WATER SAVING DYNAMIC.

Funzioni standard incluse:

La cartuccia **ENERGY SAVING** di serie evita la richiesta accidentale e involontaria di acqua calda, consentendo un risparmio energetico. Questa funzione prevede l'apertura in sola acqua fredda quando la leva è allineata alla bocca del miscelatore; per l'erogazione di acqua calda è invece necessario un movimento volontario della leva verso sinistra.

Aeratore **WATER SAVING** di serie. I miscelatori CLASS LINE ECO sono dotati di serie di un aeratore con limitazione di portata di 6 litri al minuto (disponibile anche nelle varianti da 8, 4, 3 L / min).

Per ottimizzare il risparmio, la collezione CLASS LINE ECO può essere integrata, su richiesta, anche con le seguenti tecnologie opzionali:

Tecnologia **ANTISCALDING** per limitare la temperatura massima dell'acqua erogabile. Questa tecnologia applica una speciale ghiera sulla cartuccia che permette, previa regolazione durante l'installazione, la limitazione della temperatura massima erogabile, impedendo la completa rotazione della maniglia verso l'acqua calda.

Tecnologia **WATER SAVING DYNAMIC**: un promemoria per utilizzare solo la quantità di acqua strettamente necessaria ad ogni operazione. Questo sistema permette di percepire una leggera limitazione all'apertura della leva intorno al 50% dell'erogazione massima d'acqua del miscelatore: un invito per l'utente a non aprire completamente il flusso dell'acqua quando non strettamente necessario. Superando questa leggera resistenza, l'erogazione del flusso al 100% della portata rimane sempre possibile e con la solita morbidezza della leva.

ECO program is created to control consumption for effective economic and environmental savings. CLASS LINE ECO combines different saving technologies: ENERGY SAVING cartridge, WATER SAVING aerator, ANTISCALDING ring, WATER SAVING DYNAMIC lever.

Standard features included:

ENERGY SAVING cartridge as standard equipment avoids the accidental and unintentional request of hot water, thus allowing energy savings. This function provides for opening in only cold water when the lever is aligned with the mixer spout; for the supply of hot water a voluntary movement of the lever to the left is instead necessary.

WATER SAVING aerator: CLASS LINE ECO mixers are standard equipped with a low flow aerator with a limitation of 6 liters per minute (also available in 8, 4, 3 L / min variants).

To optimize savings, CLASS LINE ECO collection can also be easily integrated, on demand, with the following optional technologies:

ANTISCALDING ring technology to limit the maximum temperature of the water supplied. This technology applies a special ring nut on the cartridge that allows, after adjustment during installation, the limitation of the maximum deliverable temperature, preventing the complete rotation of the lever towards hot water.

WATER SAVING DYNAMIC technology: a reminder to use only the amount of water strictly necessary for each operation. During the opening phase this system provides a slight limitation of the lever around the 50% of the maximum water supply: an invitation for the user not to fully open the water flow when not strictly necessary. By overcoming this slight resistance, the delivery of the flow at 100% of the flow is always possible and with the usual softness of the lever.



STANDARD ECO



ENERGY SAVING



WATER SAVING



OPTIONS:
 3 L/MIN
 4 L/MIN
 8 L/MIN

COD. 83L6
 STANDARD 6 L/min

OPTIONAL ECO



ANTISCALDING



WATER SAVING DYNAMIC





ABSOLUTE

ENERGY

VANITY

INFINITY

DREAM

CLASS LINE

CLASS LINE ECO

La serie Eco viene proposta in una gamma di articoli in cui la tecnologia Eco trova migliori benefici nell'uso.

Gli articoli doccia e vasca non sono stati proposti in quanto si presuppone che non vi sia la necessità di apertura in acqua fredda in quanto gli ambienti vasca e doccia sono generalmente utilizzati per loro natura con acqua miscelata/calda.

Per completare la gamma Eco con gli articoli vasca/doccia si consiglia di utilizzare la serie nella versione cartuccia standard.

Le versioni eco vasca e doccia sono comunque disponibili a richiesta.

The Eco series covers a range of items in which the Eco technology finds best benefit of use.

The shower and bathtub items are not offered because it is assumed that there is no need to open in cold water as the bathtub and shower environments are generally used with mixed/hot water for their nature.

To complete the Eco range with bath/shower items, we suggest to use the series in standard cartridge version.

The bath and shower eco versions are anyway available on demand.

CLASS LINE ECO

FLESSIBILI MADE IN ITALY,
IN GOMMA ALIMENTARE EPDM,
RACCORDATI CON
MACCHINE AUTOMATICHE
MADE IN ITALY FLEXIBLE HOSES,
WITH EPDM ALIMENTARY RUBBER,
MADE BY AUTOMATIC
ASSEMBLING MACHINES

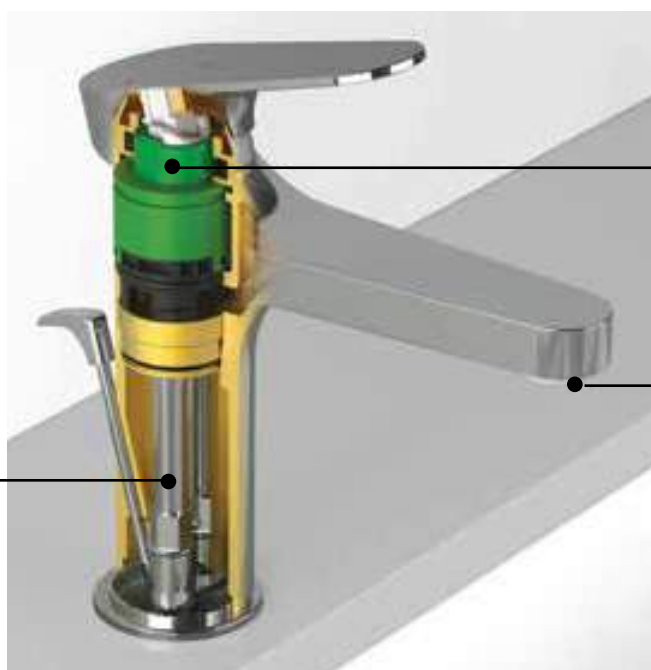

CARTUCCIA MADE IN ITALY
TECNOLOGICA REALIZZATA
CON PLASTICA
ALIMENTARE
ECO FRIENDLY
MADE IN ITALY ECO
FRIENDLY TECHNOLOGIC
CARTRIDGE

AERATORE A
RISPARMIO IDRICO
WATER SAVING
AERATOR

WINNER

WINNER ECO

LAVABI ECO - ECO WASHBASIN MIXERS 

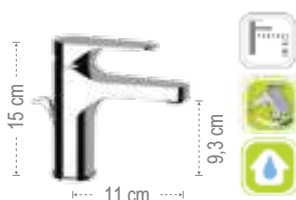

Miscelatore monocomando lavabo.
Single-lever basin mixer.

LE10LT6
con scarico.
with pop-up waste.



LE11LT6
senza scarico.
without waste.



LE12LT6
senza scarico e
senza foro sul corpo.
*without waste and
without body hole.*

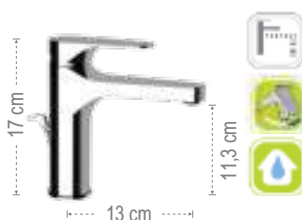

Miscelatore monocomando lavabo
alto L.
Single-lever L high basin mixer.

LE10LLT6
con scarico.
with pop-up waste.



LE11LLT6
senza scarico.
without waste.

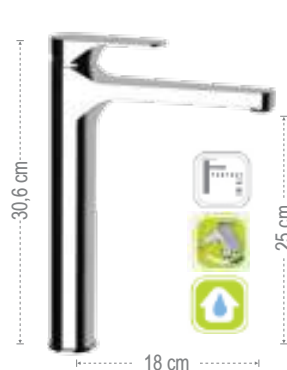

Miscelatore monocomando lavabo
alto XL.
Single-lever XL high basin mixer.

LE10LXLLT6
con click-clack e troppo pieno.
*with click-clack waste
and overflow.*



LE11LXLLT6
senza scarico.
without waste.



LE18LT6
Miscelatore monocomando lavabo
da terra, con scarico click-clack con
troppo pieno.
*Single-lever mixer for floor mounting,
with click-clack waste with overflow.*



LE15LT6
Miscelatore monocomando a
incasso per lavabo, con piastra
rettangolare in ottone.
*Single-lever built-in basin mixer,
with rectangular wall flange in
brass.*



LE72CLT6
Miscelatore monocomando lavabo
senza scarico, con canna corta
girevole tipo lusso.
*Single-lever basin mixer without
waste, with swivel luxury type spout.*



BIDET ECO - ECO BIDET MIXERS 

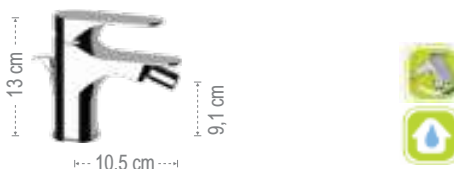

Miscelatore monocomando bidet.
Single-lever bidet mixer.

LE20LT6
con scarico.
with pop-up waste.



LE21LT6
senza scarico.
without waste.



LE65LT6
Miscelatore incasso per shut-off comprensivo di: doccetta shut-off, supporto
doccia-presa acqua su piastra in ottone e flessibile doccia cm 120.
*Built-in shower mixer set including: shut-off, shower holder-water punch on
flange, all in brass and shower flexible cm 120.*

SOFFIONI - SHOWER HEADS



351AXLT8

Soffione con disco anticalcare a snodo Ø 7 cm con limitatore di portata a 8 litri/minuto, con scatola.
Shower-head with anti-limestone jet Ø 7 cm with balljoint with 8 liters/minute flow limiter, box included.



354EC20XLT8

Soffione a pioggia minimale, in abs cromato Ø 20 cm, con getti in silicone anticalcare con limitatore di portata a 8 litri/minuto, con scatola.
c.p. abs shower head, rain jet Ø 20 cm, with anti-limestone silicon jets with 8 liters/minute flow limiter, box included..



357UFM25XLT8

Soffione doccia ultra piatto in acciaio inox lucidato a specchio Ø 25 cm, con limitatore di portata a 8 litri/minuto, con scatola.
Ultra slim stainless steel mirror polished shower head Ø 25 cm, with 8 liters/minute flow limiter, box included.



357UFS25XLT8

Soffione doccia ultra piatto in acciaio inox lucidato a specchio 25x25cm, con limitatore di portata a 8 litri/minuto, con scatola.
Ultra slim stainless steel mirror polished shower head 25x25 cm, with 8 liters/minute flow limiter, box included.



CUCINA ECO -ECO KITCHEN MIXERS



LE72LT6

Miscelatore monocomando monoforo 90°, con bocca alta girevole a "U".
Single-lever sink mixer 90°, swivel "U" spout.



LE42LT6

Miscelatore monocomando per lavello, con bocca alta girevole tipo lusso.
Single-lever one-hole sink mixer, with swivel luxury type spout.



LE42CLT6

Miscelatore monocomando per lavello, con canna corta girevole, tipo lusso.
Single-lever one-hole sink mixer, with high swivel spout, shorter model, luxury type.



LE42ULT6

Miscelatore monocomando per lavello, con bocca girevole a "U".
Single-lever sink mixer, with swivel "U" spout.



LE41LT6

Miscelatore monocomando per lavello a muro con canna girevole.
Single-lever wall mounted sink mixer with swivel spout.



LE41SLT6

Miscelatore monocomando per lavello a muro, con bocca a "S" con canna girevole.
Single-lever wall mounted sink mixer, with "S" swivel spout.



LE40LT6

Miscelatore monocomando per lavello con canna girevole.
Single-lever one-hole sink mixer with swivel spout.



LE42RLT6

Miscelatore monocomando monoforo 90° per lavello, con bocca alta girevole ed abbattibile, tipo lusso, modello sottofinestra.
Single-lever one-hole sink mixer, with high swivel and foldable spout, luxury type, under window type.



Miscelatore lavabo/vasca con canna fusa lunga 30 cm, con deviatore integrato.
Wall basin/bath single lever mixer with swivel long casted spout 30 cm, with diverter integrated.

LE49LT6

con flessibile cm 150 e doccia a 4 funzioni con getti in silicone anticalcare e supporto snodato.
with flexible cm 150 and 4 functions antilimestone handshower with silicon jets and swivel shower holder.



LE46LT6

senza kit doccia.
without shower kit.

ABSOLUTE

ENERGY

VANITY

INFINITY

DREAM

CLASS LINE

CLASS LINE ECO

WINNER

WINNER ECO

WINNER

WINNER



Una linea semplice, progettata nei minimi dettagli per essere leggera ed estremamente funzionale in tutte le sue figure di bagno e cucina. Le sue forme essenziali si inseriscono con facilità in contesti moderni, mentre i suoi contorni discreti aggiungono un tocco di eleganza alle ambientazioni più classiche. La serie WINNER è il compromesso vincente per chi desidera una soluzione pratica, economica e funzionale senza rinunciare allo stile e all'estetica degli arredi. La serie è dotata di cartuccia a dischi ceramici Ø 35 mm.

A simple line, designed up to the minimum detail to be lightweight and extremely functional in all its models for bathroom and kitchen. Its essential shapes easily fit in modern contexts, while its soft edges add a touch of elegance to the most traditional environments. The WINNER series is the winning compromise for those who want a convenient, economical and practical solution without sacrificing style and aesthetics of the furnishings. The series is equipped with a Ø 35 mm ceramic disc cartridge.



ABSOLUTE

ENERGY

VANITY

INFINITY

DREAM

CLASS LINE

CLASS LINE ECO

WINNER

WINNER ECO

WINNER



NO
nero opaco
matt black

WINNER

OPZIONI DI FINITURA

Questa collezione di rubinetteria è disponibile con diverse opzioni di finitura, scegli il colore perfetto per il tuo progetto di arredo!
Rispondendo alle esigenze stilistiche dei progetti più ambiziosi, Remer Rubinetterie ha selezionato colori alternativi, oltre al cromato, studiati per arricchire, personalizzare e differenziare gli interni di bagno e cucina.

[Per confermare la propria scelta, aggiungere il codice della finitura al termine del codice prodotto durante la fase di acquisto.]

WINNER

FINISHING OPTIONS

*This faucet collection is available with different finishing options, choose the perfect color to customize your interior!
Responding to the stylistic needs of the most ambitious designs, Remer Rubinetterie selected alternative colors, in addition to chrome, to enrich, customize and differentiate bathroom and kitchen interiors.*

[To confirm your choice, add the finishing code at the end of the item code during the purchase phase.]



ABSOLUTE

ENERGY

VANITY

INFINITY

DREAM

CLASS LINE

CLASS LINE ECO

WINNER

WINNER ECO

CR

cromo
chrome

CR

FIN 1

nero opaco
matt black

NO

bianco opaco
matt white

BO

nichel spazzolato
brushed nickel

NP

LAVABI - WASHBASIN MIXERS



Miscelatore monocomando lavabo.
Single-lever basin mixer.

W10

con scarico.
with pop-up waste.



W10P

con scarico in plastica.
with plastic waste.



W11

senza scarico.
without waste.



W12

senza scarico e senza foro sul
corpo.
without waste and without body
hole.



Miscelatore monocomando lavabo.
Single-lever basin mixer.

W10S

con scarico.
with pop-up waste.



W11S

senza scarico.
without waste.



Miscelatore monocomando lavabo alto L.
Single-lever high L basin mixer.

W10L

con scarico click-clack
con troppopieno.
with click-clack
waste and overflow



W11L

senza scarico.
without waste.

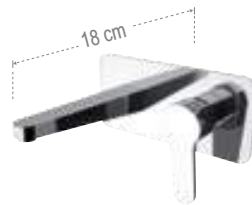

W15

Miscelatore monocomando a
incasso per lavabo, con piastra
orizzontale in ottone.
Single-lever built-in basin mixer,
with wall flange in brass.



W72C

Miscelatore monocomando
lavabo senza scarico, con canna
corta girevole a "U", tipo lusso.
Single-lever basin mixer without
waste, with short swivel "U"
spout, luxury type.



W57

Miscelatore monocomando lavabo
due fori, senza scarico.
Two holes single-lever washbasin
mixer, without waste.



91L

Bocca incasso.
Built-in spout.

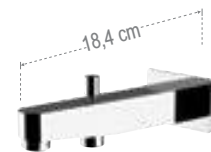

91LD

Bocca incasso con
deviatore integrato.
Built-in spout with diverter.

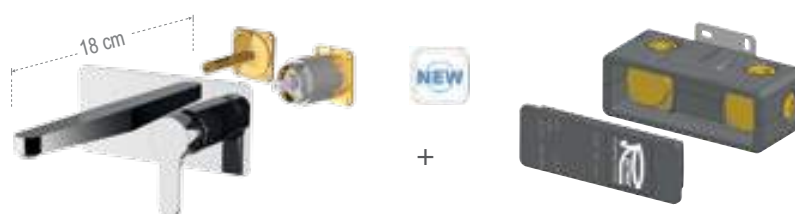

LAVABO BOX INCASSO - BUILT-IN BOX WASHBASIN MIXER

**W15KB**

Miscelatore monocomando a incasso per lavabo, con piastra in ottone e bocca da abbinare al box incasso.

Single-lever built-in basin mixer, with wall flange in brass and spout, to match with the built-in box.

**RRBOX15**

Box da incasso per miscelatore monocomando a incasso per lavabo.

Built-in box for single-lever built-in basin mixer.

W15LKB

Lunghezza bocca 23 cm.
Spout length cm 23.



BIDET - BIDET MIXERS



Miscelatore monocomando bidet.
Single-lever bidet mixer.

W20

con scarico.
with pop-up waste.

**W20P**

con scarico in plastica.
with plastic waste.

**W21**

senza scarico.
without waste.



Miscelatore incasso per shut-off con supporto doccia/ presa acqua integrato, attacco conico da 1/2", tutto in ottone.

Built-in shower mixer with integrated shower holder/ water punch on flange all in brass, with 1/2 connection.

W65W

con doccetta shut-off e flessibile cm 120.
including shut-off and flexible hose cm 120.

**W65B**

senza kit doccia.
without shower kit.



Miscelatore monocomando esterno doccia, interasse 100 mm.
Wall mounted single lever shower mixer, interaxis 100 mm.

WC31DP

con doccetta shut-off e flessibile cm 120.
including shut-off and flexible hose cm 120.

**WC31**

senza kit doccia.
without shower kit.



ABSOLUTE

ENERGY

VANITY

INFINITY

DREAM

CLASS LINE

CLASS LINE ECO

WINNER

WINNER ECO

VASCA - BATH MIXERS



Miscelatore vasca con deviatore integrato.
Wall mounted bath mixer with integrated diverter.

W02

con flessibile cm 150 e doccetta a 4 funzioni con getti in silicone anticalcare e supporto snodato.
with flexible cm 150 and 4 functions antilimestone handshower with silicon jets and swivel shower holder.



W05

senza kit doccia.
without shower kit.



Miscelatore monocomando per vasca.
Single lever bath mixer with diverter.

W03

con flessibile cm 150 e doccetta a 4 funzioni, getti in silicone anticalcare e supporto snodato.
with flexible cm 150 and 4 functions antilimestone handshower with silicon jets and swivel shower holder.



W04

senza kit doccia.
without shower kit.



Miscelatore lavabo/vasca con canna fusa lunghezza 30 cm con deviatore integrato.
Wall mounted basin/bath single lever mixer with long casted spout length 30 cm and integrated diverter.

W49

con flessibile cm 150 e doccetta a 4 funzioni con getti in silicone anticalcare e supporto snodato.
with flexible cm 150 and 4 functions antilimestone handshower with silicon jets and swivel shower holder.



W46

senza kit doccia.
without shower kit.



W07

Miscelatore monocomando bordo vasca con deviatore a leva integrato nella bocca minimale e doccetta estraibile in ABS cromato a 4 funzioni, flessibile 150 cm.
Single lever deck bath mixer with lever diverter integrated on the spout, with minimal spout and pull-out 4 functions chrome plated ABS handshower, flexible hose 150 cm.



W07UF

Miscelatore monocomando bordo vasca con deviatore integrato nel miscelatore, bocca a cascata e doccetta estraibile in ABS cromato a 4 funzioni, flessibile 150 cm.
Single lever deck bath mixer with diverter integrated on the mixer, with waterfall spout and pull-out 4 functions chrome plated ABS handshower, flexible hose 150 cm.



DOCCE - EXPOSED SHOWER MIXERS



Miscelatore doccia con leva frontale.
Exposed shower mixer with frontal lever.

W38

con flessibile cm 150 e doccetta a 4 funzioni con getti in silicone anticalcare e supporto snodato.
with flexible cm 150 and 4 functions antilimestone handshower with silicon jets and swivel shower holder.



W33

senza kit doccia.
without shower kit.



Miscelatore doccia.
Exposed shower mixer.

W39

con flessibile cm 150 e doccetta a 4 funzioni con getti in silicone anticalcare e supporto snodato.
with flexible cm 150 and 4 functions antilimestone handshower with silicon jets and swivel shower holder.



W31

senza kit doccia.
without shower kit.



89 cm

315L318MP

Saliscendi cromato con asta tonda, doccetta anticalcare a 4 funzioni con getti anticalcare e flessibile in acciaio inox 150 cm.
Sliding rail set with round rod and antilimestone 4 functions handshower and stainless steel flexible hose 150 cm.



ABSOLUTE

ENERGY

VANITY

INFINITY

DREAM

CLASS LINE

CLASS LINE ECO

WINNER

WINNER ECO

INCASSI DOCCIA - BUILT-IN SHOWER MIXERS



W30

Miscelatore monocomando a incasso per doccia completo.
Complete built-in shower single lever mixer.



W09

Miscelatore monocomando a incasso con deviatore per vasca/doccia completo.
Complete built-in bath/shower single-lever mixer with diverter.



N30B

Solo parte interna miscelatore monocomando incasso doccia.
Single-lever shower mixer (only built-in components).



W30E

Solo parte esterna miscelatore monocomando incasso doccia.
Single-lever shower mixer (only external components).



N09B

Solo parte interna miscelatore monocomando incasso vasca/doccia con deviatore.
Single-lever bath/shower mixer with diverter (only built-in components).



W09E

Solo parte esterna miscelatore monocomando incasso vasca/doccia con deviatore.
Single-lever bath/shower mixer with diverter (only external components).



W92

Miscelatore monocomando per doccia, con deviatore a due posizioni (due uscite ed una entrata) su piastra unica.
Single-lever shower mixer with 2 positions diverter (2 outlets and 1 inlet) on single flange.



W93

Miscelatore monocomando per doccia con deviatore a tre vie (una entrata e tre uscite) su unica piastra.
Single lever built-in shower mixer with three ways diverter (1 inlet and 3 outlets) on single flange.



W94

Miscelatore monocomando per doccia, con deviatore a 4 posizioni (4 uscite ed 1 entrata) su piastra unica.
Single-lever shower mixer with 4 positions diverter (4 outlets and 1 inlet,) on single flange.



W95

Miscelatore monocomando per doccia, con deviatore a 5 posizioni (5 uscite ed una entrata) su piastra unica.
Single-lever shower mixer with 5 positions diverter (5 outlets and 1 inlet) on single flange.



BOX INCASSO - BUILT-IN BOX MIXERS



RRBOX
Box da incasso per miscelatore doccia con deviatore.
Built-in box for shower mixer with diverter.



W30KB
Miscelatore monocomando da incasso per doccia completo.
Complete built-in shower single lever mixer.

OPPURE
OR



W09KB
Set miscelatore doccia con deviatore da abbinare al box incasso.
Shower mixer set with diverter to match with the built-in box.



RRBOX92
Box da incasso per miscelatore doccia due vie.
Built-in box for two ways shower mixer.



W92KB
Set miscelatore doccia due vie da abbinare al box incasso.
Two ways shower mixer set to match with the built-in box.



RRBOX93
Box da incasso per miscelatore doccia tre vie.
Built-in box for three ways shower mixer.



W93KB
Set miscelatore doccia tre vie da abbinare al box incasso.
Three ways shower mixer set to match with the built-in box.



COLONNE DOCCIA - SHOWER COLUMN

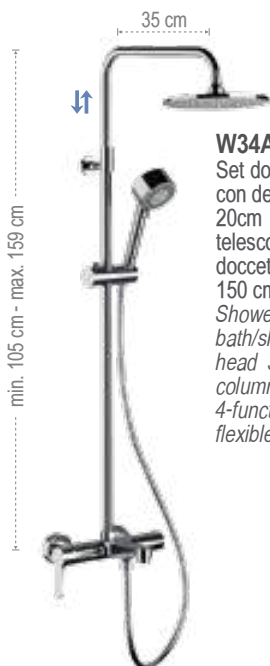

W34AEC20
Set doccia composto da: miscelatore esterno con deviatore vasca/doccia, soffione in abs Ø 20cm 354EC20X, colonna doccia in ottone telescopica, altezza asta regolabile 329A, doccetta in abs a 4 funzioni 319MO, flessibile 150 cm.
Shower set including: exposed mixer with bath/shower diverter, abs Ø 20 cm shower head 354EC20X, telescopic brass shower column, with height-adjustable rod 329A, 4-function abs hand shower 319MO, 150 cm flexible hose.

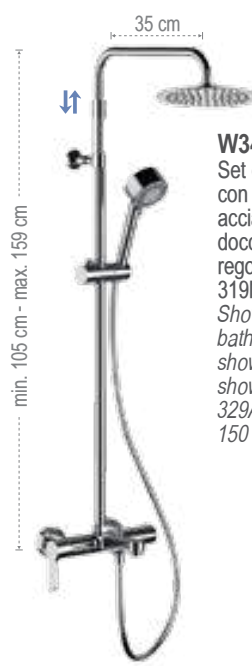

W34AUFM20
Set doccia composto da: miscelatore esterno con deviatore vasca/doccia, soffione in acciaio inox Ø 20 cm 357UFM20X, colonna doccia in ottone telescopica, altezza asta regolabile 329A, doccetta in abs a 4 funzioni 319MO, flessibile 150 cm.
Shower set including: exposed mixer with bath/shower diverter, stainless steel Ø 20cm shower head 357UFM20X, telescopic brass shower column, with height-adjustable rod 329A, 4-function abs hand shower 319MO, 150 cm flexible hose.





W37AEC20

Set doccia composto da: miscelatore esterno con attacco superiore, soffione in abs Ø 20cm 354EC20X, colonna doccia in ottone telescopica, altezza asta regolabile, con deviatore 330A, doccetta in abs a 4 funzioni 319MO, flessibile 150 cm.

Shower set including: exposed mixer with upper connection, abs Ø 20 cm shower head 354EC20X, telescopic brass shower column, with height-adjustable rod, with diverter 330A, 4-function abs hand shower 319MO, 150 cm flexible hose.



W37AUFM20

Set doccia composto da: miscelatore esterno con attacco superiore, soffione in acciaio inox Ø 20 cm 357UFM20X, colonna doccia in ottone telescopica, altezza asta regolabile, con deviatore 330A, doccetta in abs a 4 funzioni 319MO, flessibile 150 cm.

Shower set including: exposed mixer with upper connection, stainless steel Ø 20cm shower head 357UFM20X, telescopic brass shower column, with height-adjustable rod, with diverter 330A, 4-function abs hand shower 319MO, 150 cm flexible hose.



KIT WELLNESS - WELLNESS KITS



W09S02EC20

Set doccia composto da: miscelatore a incasso con deviatore, soffione in abs Ø 20cm 354EC20X, braccio in ottone 30 cm, presa acqua a muro con supporto doccetta, doccetta in abs a 4 funzioni 319MO, flessibile 150 cm.

Shower set including: built-in mixer with diverter, abs Ø 20 cm shower head 354EC20X, brass arm 30 cm, wall water connection with shower holder, 4-function abs hand shower 319MO, 150 cm flexible hose.



W09S01EC20

Set doccia composto da: miscelatore a incasso con deviatore, soffione in abs Ø 20cm 354EC20X, braccio in ottone 30 cm, saliscendi tondo 315R, presa acqua a muro, doccetta in abs a 4 funzioni 319MO, flessibile 150 cm.

Shower set including: built-in mixer with diverter, abs Ø 20 cm shower head 354EC20X, brass arm 30 cm, round sliding rail 315R, wall water connection, 4-function abs hand shower 319MO, 150 cm flexible hose.



ABSOLUTE

ENERGY

VANITY

INFINITY

DREAM

CLASS LINE

CLASS LINE ECO

WINNER

WINNER ECO

WINNER | SET

COMPOSIZIONE DEL BOX - BOX COMPOSITION:

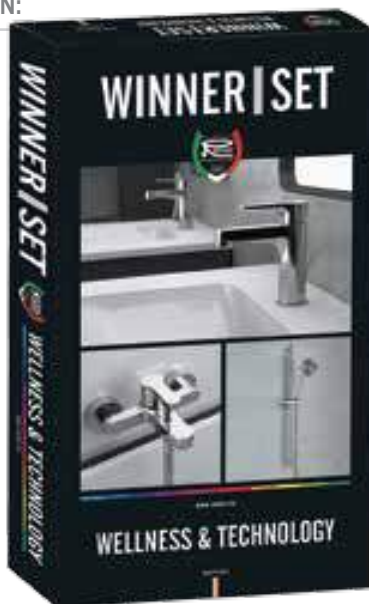

W0510315RMOI

Set composto da: miscelatore vasca esterno W05, saliscendi tondo 315R, miscelatore per lavabo con scarico W10, doccetta in abs a 4 funzioni 319MO, flessibile 150 cm.

Set including: Exposed bath mixer W05, round sliding rail 315R, basin mixer with pop-up waste W10, 4-function abs hand shower 319MO, 150 cm flexible hose.



COMPOSIZIONE DEL BOX - BOX COMPOSITION:



W0910315RMOI

Set composto da: miscelatore a incasso con deviatore, soffione in abs Ø 20cm 354EC20X, braccio in ottone 30 cm, saliscendi tondo 315R, miscelatore per lavabo con scarico W10, presa acqua a muro, doccetta in abs a 4 funzioni 319MO, flessibile 150 cm.

Set including: built-in mixer with diverter, abs Ø 20 cm shower head 354EC20X, brass arm 30 cm, round sliding rail 315R, basin mixer with pop-up waste W10, wall water connection, 4-function abs hand shower 319MO, 150 cm flexible hose..



COMPOSIZIONE DEL BOX - BOX COMPOSITION:



W 10



W 20



W 05



315R 319MOI

**W051020315RMOI**

Set composto da: miscelatore vasca esterno W05, saliscendi tondo 315R, miscelatore per lavabo con scarico W10, miscelatore bidet con scarico (W20), doccia in abs a 4 funzioni 319MO, flessibile 150 cm.

Set including: Exposed bath mixer W05, round sliding rail 315R, basin mixer with pop-up waste W10, bidet mixer with pop-up waste (W20); 4-function abs hand shower 319MO, 150 cm flexible hose.



W05

CUCINA - KITCHEN MIXERS



W84

Miscelatore monocomando per lavello, con canna alta girevole e sistema di doccetta monofunzione estraibile.

Single-lever sink mixer with high swivel spout and single-function system pull-out hand shower.



W84DJ

Miscelatore monocomando per lavello, con canna alta girevole e doccetta estraibile a due funzioni.

Single-lever sink mixer with high swivel spout and 2-functions pull-out hand shower.



W72

Miscelatore monocomando monoforo 90°, con canna alta girevole a "U".

Single-lever sink mixer 90°, high swivel "U" spout.



W72U

Miscelatore monocomando monoforo 90° con canna alta quadrata a "U" girevole e leva laterale.

Single-lever one-hole sink mixer, 90° with high movable squared "U" spout and side lever.



W42B

Miscelatore monocomando per lavello, con bocca alta girevole.

Single-lever one-hole sink mixer, with high swivel spout.



W42

Miscelatore monocomando per lavello, con bocca alta girevole.

Single-lever one-hole sink mixer, with high swivel spout.



W42U

Miscelatore monocomando per lavello, con bocca alta quadrata a "U" girevole.

Single-lever one-hole sink mixer, with squared "U" high swivel spout.

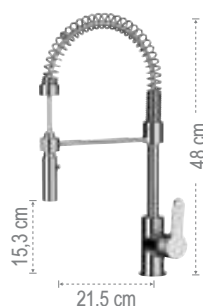

W77E

Miscelatore monocomando lavello a molla con doccetta estraibile dal supporto ed orientabile a due funzioni e cartuccia Ø 35.

Spring single-lever sink mixer with detachable and adjustable 2-functions handshower and Ø 35 mm cartridge.



W533

Miscelatore lavello monocomando con flessibile nero rivestito con molla "fine design" girevole 360°, con doccetta estraibile di supporto ed orientabile a due funzioni e cartuccia Ø 35.

Single-lever mixer with black flexible hose coated with "fine design" spring, 360° swivel, with detachable and adjustable 2 functions handshower and Ø 35 mm cartridge.





W42R

Miscelatore monocomando monoforo 90° per lavello, con bocca alta girevole ed abbattibile, tipo lusso, modello sottofinestra.
Single-lever one-hole sink mixer, with high spout swivel and movable, luxury type, under window type.



W43

Miscelatore monocomando per lavello a muro, con leva frontale e bocca alta girevole.
Single-lever wall mounted sink mixer, with frontal lever and high swivel spout.



W43B

Miscelatore monocomando per lavello a muro, con leva frontale e bocca alta a "U" girevole.
Single-lever wall mounted sink mixer, with frontal lever and high swivel "U" spout.



W40

Miscelatore monocomando per lavello con canna girevole.
Single-lever one-hole sink mixer, with swivel spout.



W41

Miscelatore monocomando per lavello a muro con canna lunghezza 20 cm.
Single-lever wall mounted sink mixer with spout length 20 cm.



W41S

Miscelatore monocomando per lavello a muro con canna a "S" lunghezza 21 cm.
Single-lever wall mounted sink mixer with "S" spout length 21 cm.

TOUCH-ME



WT72

Miscelatore monocomando lavello, monoforo 90° con canna alta ad "U" dotata di tecnologia Touch-Me con leva laterale e bocca girevole. Dotato di cartuccia Ø35.
Single-lever sink mixer 90°, high "U" spout equipped with Touch-Me system with side lever and swivel spout. Equipped with Ø35 cartridge.



WT72C

Miscelatore monocomando lavello, monoforo 90° con canna corta ad "U" dotata di tecnologia Touch-Me con leva laterale e bocca girevole. Dotato di cartuccia Ø35.
Single-lever sink mixer 90°, short "U" spout equipped with Touch-Me system with side lever and swivel spout. Equipped with Ø35 cartridge.



WT72U

Miscelatore monocomando lavello, monoforo 90° con canna alta quadra a "U" dotata di tecnologia Touch-Me con leva laterale e bocca girevole. Dotato di cartuccia Ø35.
Single-lever sink mixer 90°, high squared "U" spout equipped with Touch-Me system with side lever and swivel spout. Equipped with Ø35 cartridge.

**ACQUA PURIFICATA
PURIFIED WATER**



W79DW

Miscelatore lavello serie Winner a tre vie di ingresso con bocca girevole e due vie d'uscita completamente indipendenti, con selezione acqua potabile tramite la leva.
Three ways inlet Winner series single lever sink mixer, with swivel spout and two fully independent outlets, with selection for drinking water directly from the lever.



ABSOLUTE

ENERGY

VANITY

INFINITY

DREAM

CLASS LINE

CLASS LINE ECO

WINNER

WINNER ECO

WINNER ECO



WINNER ECO è una collezione monocomando dal design moderno e giovanile, creata per controllare e ridurre i consumi idrici ed energetici in casa. La combinazione di più tecnologie di risparmio permette infatti di limitare alla sola necessità sia il consumo di acqua che l'utilizzo di acqua calda, senza stravolgere le abitudini quotidiane. La serie è dotata di cartuccia ENERGY SAVING a dischi ceramici Ø 35 mm.

WINNER ECO is a single-lever collection with a modern and youthful design, created to control and reduce water and energy consumption in the home. The combination of different saving technologies limit to the actual need both the consumption of water and the use of hot water, without upsetting daily habits. The series is equipped with a Ø 35 mm ceramic disc ENERGY SAVING cartridge.

ABSOLUTE

ENERGY

VANITY

INFINITY

DREAM

CLASS LINE

CLASS LINE ECO

WINNER

WINNER ECO





ACQUA E AMBIENTE
WATER & ENVIRONMENT
WATER SAVING

PROGRAMMA ECO
ECO PROGRAM



Design e tecnologia ambientale
Design and environmental technology

Il programma ECO nasce per il controllo dei consumi, per un reale risparmio sia economico che ambientale. WINNER ECO combina diverse tecnologie di risparmio: cartuccia ENERGY SAVING, aeratore WATER SAVING, anello ANTISCALDING, leva WATER SAVING DYNAMIC.

Funzioni standard incluse:

La cartuccia **ENERGY SAVING** di serie evita la richiesta accidentale e involontaria di acqua calda, consentendo un risparmio energetico. Questa funzione prevede l'apertura in sola acqua fredda quando la leva è allineata alla bocca del miscelatore; per l'erogazione di acqua calda è invece necessario un movimento volontario della leva verso sinistra.

Aeratore **WATER SAVING** di serie. I miscelatori WINNER ECO sono dotati di serie di un aeratore con limitazione di portata di 6 litri al minuto (disponibile anche nelle varianti da 8, 4, 3 L / min).

Per ottimizzare il risparmio, la collezione WINNER ECO può essere integrata, su richiesta, anche con le seguenti tecnologie opzionali:

Tecnologia **ANTISCALDING** per limitare la temperatura massima dell'acqua erogabile. Questa tecnologia applica una speciale ghiera sulla cartuccia che permette, previa regolazione durante l'installazione, la limitazione della temperatura massima erogabile, impedendo la completa rotazione della maniglia verso l'acqua calda.

Tecnologia **WATER SAVING DYNAMIC**: un promemoria per utilizzare solo la quantità di acqua strettamente necessaria ad ogni operazione. Questo sistema permette di percepire una leggera limitazione all'apertura della leva intorno al 50% dell'erogazione massima d'acqua del miscelatore: un invito per l'utente a non aprire completamente il flusso dell'acqua quando non strettamente necessario. Superando questa leggera resistenza, l'erogazione del flusso al 100% della portata rimane sempre possibile e con la solita morbidezza della leva.

ECO program is created to control consumption for effective economic and environmental savings. WINNER ECO combines different saving technologies: ENERGY SAVING cartridge, WATER SAVING aerator, ANTISCALDING ring, WATER SAVING DYNAMIC lever.

Standard features included:

ENERGY SAVING cartridge as standard equipment avoids the accidental and unintentional request of hot water, thus allowing energy savings. This function provides for opening in only cold water when the lever is aligned with the mixer spout; for the supply of hot water a voluntary movement of the lever to the left is instead necessary.

WATER SAVING aerator: WINNER ECO mixers are standard equipped with a low flow aerator with a limitation of 6 liters per minute (also available in 8, 4, 3 L / min variants).

To optimize savings, WINNER ECO collection can also be easily integrated, on demand, with the following optional technologies:

ANTISCALDING ring technology to limit the maximum temperature of the water supplied. This technology applies a special ring nut on the cartridge that allows, after adjustment during installation, the limitation of the maximum deliverable temperature, preventing the complete rotation of the lever towards hot water.

WATER SAVING DYNAMIC technology: a reminder to use only the amount of water strictly necessary for each operation. During the opening phase this system provides a slight limitation of the lever around the 50% of the maximum water supply: an invitation for the user not to fully open the water flow when not strictly necessary. By overcoming this slight resistance, the delivery of the flow at 100% of the flow is always possible and with the usual softness of the lever.



STANDARD ECO



ENERGY SAVING



WATER SAVING



OPTIONS:
3 L/MIN
4 L/MIN
8 L/MIN
COD. 83L6
STANDARD 6 L/min

OPTIONAL ECO



ANTISCALDING



WATER SAVING DYNAMIC





WE10LLT6

La serie Eco viene proposta in una gamma di articoli in cui la tecnologia Eco trova migliori benefici nell'uso.

Gli articoli doccia e vasca non sono stati proposti in quanto si presuppone che non vi sia la necessità di apertura in acqua fredda in quanto gli ambienti vasca e doccia sono generalmente utilizzati per loro natura con acqua miscelata/calda. Per completare la gamma Eco con gli articoli vasca/doccia si consiglia di utilizzare la serie nella versione cartuccia standard.

Le versioni eco vasca e doccia sono comunque disponibili a richiesta.

The Eco series covers a range of items in which the Eco technology finds best benefit of use.

The shower and bathtub items are not offered because it is assumed that there is no need to open in cold water as the bathtub and shower environments are generally used with mixed/hot water for their nature.

To complete the Eco range with bath/shower items, we suggest to use the series in standard cartridge version.

The bath and shower eco versions are anyway available on demand.

ABSOLUTE

ENERGY

VANITY

INFINITY

DREAM

CLASS LINE

CLASS LINE ECO

WINNER

WINNER ECO

WINNER ECO



FLESSIBILI MADE IN ITALY,
IN GOMMA ALIMENTARE EPDM,
RACCORDATI CON MACCHINE
AUTOMATICHE
MADE IN ITALY FLEXIBLE HOSES,
WITH EPDM ALIMENTARY RUBBER,
MADE BY AUTOMATIC
ASSEMBLING MACHINES



CARTUCCIA MADE IN ITALY
TECNOLOGICA REALIZZATA
CON PLASTICA ALIMENTARE
ECO FRIENDLY
MADE IN ITALY ECO FRIENDLY
TECHNOLOGIC CARTRIDGE

AERATORE A
RISPARMIO IDRICO
WATER SAVING
AERATOR



WE10LLT6

LAVABI ECO - ECO WASHBASIN MIXERS 



Miscelatore monocomando lavabo.
Single-lever basin mixer.

WE10LT6
con scarico.
with pop-up waste.

WE11LT6
senza scarico.
without waste.

WE12LT6
senza scarico e senza foro sul corpo.
without waste and without body hole.



Miscelatore monocomando lavabo alto L.
Single-lever L high basin mixer.

WE10LLT6
con click-clack con troppo pieno.
with click-clack waste with overflow.

WE11LLT6
senza scarico.
without waste.



WE72CLT6
Miscelatore monocomando lavabo senza scarico,
con canna corta girevole a "U", tipo lusso.
Single-lever basin mixer without waste, with short swivel "U" spout, luxury type.



WE15LT6
Miscelatore monocomando a incasso per lavabo,
con piastra rettangolare in ottone.
Single-lever built-in basin mixer, with rectangular wall flange in brass.



BIDET ECO - ECO BIDET MIXERS



Miscelatore monocomando bidet.
Single-lever bidet mixer.

WE20LT6

con scarico.
with pop-up waste.

WE21LT6

senza scarico.
without waste.



WE65LT6

Miscelatore incasso per shut-off comprensivo di: doccetta shut-off, supporto doccia-presa acqua su piastra in ottone e flessibile doccia cm 120.
Built-in shower mixer set including :shut-off, shower holder-water punch on flange, all in brass and shower flexible cm 120.

SOFFIONI - SHOWER HEADS



351AXLT8

Soffione con disco anticalcare a snodo Ø 7 cm con limitatore di portata a 8 litri/minuto, con scatola.
Shower-head with anti-limestone jet Ø 7 cm with balljoint with 8 liters/minute flow limiter, box included.



354EC20XLT8

Soffione a pioggia minimale, in abs cromato Ø 20 cm, con getti in silicone anticalcare con limitatore di portata a 8 litri/minuto, con scatola.
c.p. abs shower head, rain jet Ø 20 cm, with anti-limestone silicon jets with 8 liters/minute flow limiter, box included..



357UFM25XLT8

Soffione doccia ultra piatto in acciaio inox lucidato a specchio Ø 25 cm, con limitatore di portata a 8 litri/minuto, con scatola.
Ultra slim stainless steel mirror polished shower head Ø 25 cm, with 8 liters/minute flow limiter, box included.



357UFS25XLT8

Soffione doccia ultra piatto in acciaio inox lucidato a specchio 25x25cm, con limitatore di portata a 8 litri/minuto, con scatola.
Ultra slim stainless steel mirror polished shower head 25x25 cm, with 8 liters/minute flow limiter, box included.



CUCINA ECO - ECO KITCHEN MIXERS



WE72LT6

Miscelatore monocomando monoforo 90°, con canna alta girevole a "U".
Single-lever sink mixer 90°, high swivel "U" spout.



WE42LT6

Miscelatore monocomando per lavello, con bocca alta girevole.
Single-lever one-hole sink mixer, with high swivel spout.



WE42CLT6

Miscelatore monocomando per lavello, canna corta girevole, tipo lusso.
Single-lever one-hole sink mixer, shorter swivel spout, luxury type.



WE42RLT6

Miscelatore monocomando monoforo 90° per lavello, con bocca alta girevole ed abbattibile, tipo lusso, modello sottofinestra.
Single-lever one-hole sink mixer, with swivel and foldable high spout, luxury type, under window type.



WE41LT6

Miscelatore monocomando per lavello a muro con canna girevole 20 cm.
Single-lever wall mounted sink mixer with swivel spout lenght 20 cm.



ABSOLUTE

ENERGY

VANITY

INFINITY

DREAM

CLASS LINE

CLASS LINE ECO

WINNER

WINNER ECO

DESIGN

DESIGN MINIMALE - MINIMAL DESIGN

CONTRACT

CLASSICA - CLASSIC

TERMOSTATICI - THERMOSTATICS

SENSOR & TEMPOR

ACCESSORI - ACCESSORIES



X STYLE

pag. 120



Q DESIGN

pag. 134



MINIMAL

pag. 144



QUBIKA

pag. 158



QUBIKA CASCATA

pag. 170

X STYLE

X STYLE



L'utilizzo di una cartuccia dal diametro di 25 mm rende il corpo del miscelatore particolarmente slanciato, mentre la bocca di erogazione accompagna dolcemente il fluire dell'acqua con una morbida curvatura. Una collezione di rubinetteria monocomando dall'eleganza intramontabile, disponibile in un'ampia gamma di finiture. La serie è dotata di cartuccia a dischi ceramici Ø 25 mm.

The use of a 25 mm diameter cartridge makes the mixer body particularly slender, while the spout gently accompanies the flow of water with a soft curvature. A collection of single-lever mixers with timeless elegance, available in a wide range of finishes. The series is equipped with a Ø 25 mm ceramic disc cartridge.

X STYLE

Q DESIGN

MINIMAL

QUBIKA

QUBIKA CASCATA





X STYLE

OPZIONI DI FINITURA

Questa collezione di rubinetteria è disponibile con diverse opzioni di finitura, scegli il colore perfetto per il tuo progetto di arredo!
Rispondendo alle esigenze stilistiche dei progetti più ambiziosi, Remer Rubinetterie ha selezionato colori alternativi, oltre al cromato, studiati per arricchire, personalizzare e differenziare gli interni di bagno e cucina.

[Per confermare la propria scelta, aggiungere il codice della finitura al termine del codice prodotto durante la fase di acquisto.]

X STYLE

FINISHING OPTIONS

*This faucet collection is available with different finishing options, choose the perfect color to customize your interior!
Responding to the stylistic needs of the most ambitious designs, Remer Rubinetterie selected alternative colors, in addition to chrome, to enrich, customize and differentiate bathroom and kitchen interiors.*

[To confirm your choice, add the finishing code at the end of the item code during the purchase phase.]



DO oro lucido
shiny gold

NPO nichel spazzolato opaco
matt brushed nickel

CR

	cromo chrome	CR
---	-----------------	----

FIN 1

	nero opaco matt black	NO
	bianco opaco matt white	BO
	nichel spazzolato brushed nickel	NP
	nichel spazzolato opaco matt brushed nickel	NPO

FIN 2

	cromo nero spazzolato brushed black chrome	CFP
	oro spazzolato brushed gold	BG
	oro lucido shiny gold	DO
	rame lucido shiny copper	RL

LAVABI E BIDET - WASHBASIN AND BIDET MIXERS

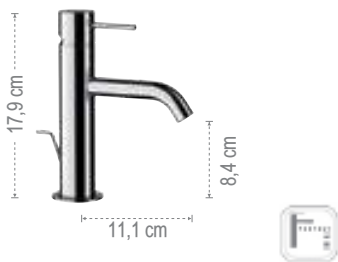

Miscelatore monocomando lavabo.
Single-lever basin mixer.

X10

con scarico.
with pop-up waste.



X11

senza scarico.
without waste.



X12

senza scarico e senza foro
sul corpo.
without waste and without
body hole.

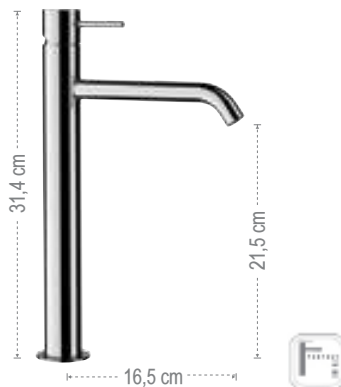

Miscelatore monocomando lavabo alto XL.
XL high single-lever basin mixer.

X10LXL

con scarico click-clack
con troppopieno.
with click-clack waste
and overflow



X11LXL

senza scarico.
without waste.

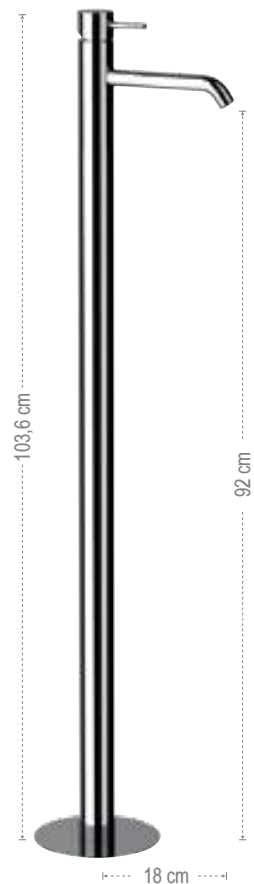

X18

Miscelatore monocomando lavabo
da pavimento con scarico
click-clack con troppopieno.
Single-lever mixer floor
mounting with click-clack waste
with overflow.



X57

Miscelatore monocomando
lavabo due fori senza scarico.
Two holes single-lever
washbasin mixer without waste.



X72C

miscelatore monocomando per
lavello con canna corta a "u", tipo
lusso.
Single-lever one-hole sink mixer
with short "u" spout, luxury type.



CUCINA - KITCHEN



X72

Miscelatore monocomando
monoforo con canna alta a "U"
girevole.
Single-lever sink mixer high
movable "U" spout.

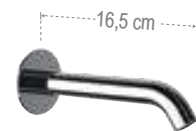

91X

Bocca incasso.
Built-in spout.



91XL

Lunghezza bocca 19 cm.
Spout length 19 cm.





X15
Miscelatore monocomando a incasso per lavabo, con piastra orizzontale in ottone.
Single-lever built-in basin mixer, with horizontal wall flange in brass.

X15L
Lunghezza bocca 19 cm.
Spout length 19 cm.



X15P
Miscelatore monocomando a incasso per lavabo, in ottone.
Single-lever built-in basin mixer with double flanges, in brass.

X15PL
Lunghezza bocca 19 cm.
Spout length 19 cm.

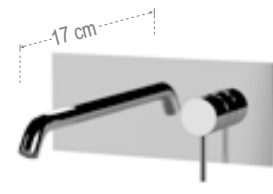

X15Q
Miscelatore monocomando a incasso per lavabo, con piastra rettangolare in ottone.
Single-lever built-in basin mixer, with rectangular wall flange in brass.

X15QL
Lunghezza bocca 19 cm.
Spout length 19 cm.

LAVABO BOX INCASSO - BUILT-IN BOX WASHBASIN MIXER



X15KB
Miscelatore monocomando a incasso per lavabo, con piastra in ottone, da abbinare al box incasso.
Single-lever built-in basin mixer, with wall flange in brass, to match with the built-in box.

X15LKB
Lunghezza bocca 19 cm.
Spout length 19 cm.



X15QKB
Miscelatore monocomando a incasso per lavabo, con piastra in ottone, da abbinare al box incasso.
Single-lever built-in basin mixer, with wall flange in brass, to match with the built-in box.

X15QLKB
Lunghezza bocca 19 cm.
Spout length 19 cm.

+



RRBOX15
Box da incasso per miscelatore monocomando a incasso per lavabo.
Built-in box for single-lever built-in basin mixer.

+



RRBOX15
Box da incasso per miscelatore monocomando a incasso per lavabo.
Built-in box for single-lever built-in basin mixer.



NR17

BOCCHIE - SPOUT

X STYLE

Q DESIGN

MINIMAL

QUBIKA

QUBIKA CASCATA



Miscelatore da soffitto in ottone, con miscelazione e controllo flusso integrati nella bocca di erogazione.
Ceiling mixer in brass, with mixing and flow control integrated in the outlet spout.

N17
lunghezza 166 cm.
length 166 cm.

N17L
lunghezza 181 cm.
length 181 cm.

N17LXL
lunghezza 231 cm.
length 231 cm.



Miscelatore da soffitto in ottone, con miscelazione e controllo flusso integrati nella bocca di erogazione, dispositivo COLOR LED LIGHT.
Ceiling mixer in brass, with mixing and flow control integrated in the outlet spout, including COLOR LED LIGHT device.

NR17
lunghezza 166 cm.
length 166 cm.

NR17L
lunghezza 181 cm.
length 181 cm.

NR17LXL
lunghezza 231 cm.
length 231 cm.



Bocca da soffitto in ottone.
Ceiling spout in brass.

91VN2
lunghezza 166 cm.
length 166 cm.

91VLN2
lunghezza 181 cm.
length 181 cm.



Bocca da soffitto in ottone, dispositivo COLOR LED LIGHT.
Ceiling spout in brass, including COLOR LED LIGHT device

91VNR
lunghezza 166 cm.
length 166 cm.

91VLNR
lunghezza 181 cm.
length 181 cm.

BIDET - BIDET MIXERS



Miscelatore monocomando bidet.
Single-lever bidet mixer.

X20

con scarico.
with pop-up waste.



X21

senza scarico.
without waste.



X22

senza scarico e senza
forosul corpo.
*without waste and
without body hole.*



Miscelatore incasso per shut-off con supporto doccia/
presa acqua integrato, attacco conico da 1/2", tutto in
ottone.

*Built-in shower mixer with integrated shower
holder/water punch on flange all in brass, with 1/2
connection.*

X65W

con doccetta shut-off
e flessibile cm 120.
*with shut-off and
flexible hose cm 120.*



N64W

Miscelatore shut-off con cartuccia
progressiva, apertura su acqua
fredda e passaggio ad acqua calda
tramite rotazione di maniglia unica,
comprensivo di doccetta shut-off e
flessibile doccia cm 120.

*Shut-off mixer with progressive
cartridge, opening with cold water,
switching on hot water by rotating
one single handle including shut-off
and shower flexible 120 cm.*



MISCELATORI VASCA E DOCCIA - SHOWER AND BATH MIXERS



Miscelatore vasca esterno.
Exposed bath mixer.

X02

con kit doccia, flessibile 150 cm e
doccetta ad una funzione in ottone.
*with shower kit, flexible 150 cm
and one function brass minimal
handshower.*



X05

senza kit doccia.
without shower kit.



Monocomando doccia esterno.
Exposed shower mixer.

X39

con kit doccia, flessibile 150 cm e
doccetta ad una funzione in ottone.
*with shower kit, flexible 150 cm
and one function brass minimal
handshower.*



X31

senza kit doccia.
without shower kit.

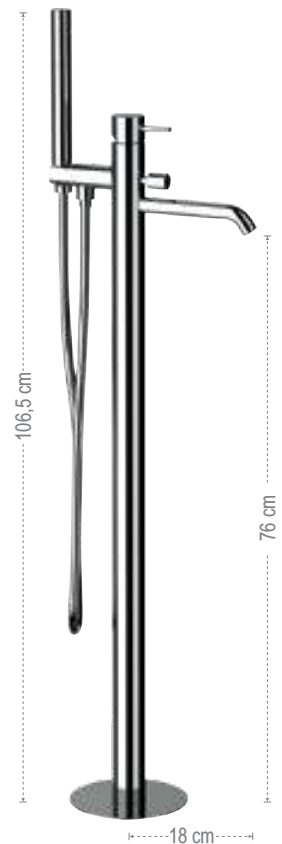

X08

Miscelatore vasca da pavimento,
con deviatore, flessibile 150 cm
e doccetta ad una funzione in
ottone.

*Freestanding bath mixer, with
diverter, flexible 150 cm and
one function brass minimal
handshower.*





X STYLE

Q DESIGN

MINIMAL

QUBIKA

QUBIKA CASCATA

X08 (FIN1 - NO)

INCASSI DOCCIA - BUILT-IN SHOWER MIXERS



X30L
Miscelatore monocomando a incasso per doccia completo.
Complete single lever built-in shower mixer.



X09L
Miscelatore monocomando a incasso con deviatore per vasca/doccia completo.
Complete single lever built-in bath/shower mixer with diverter.



N30B
Solo parte interna miscelatore monocomando incasso doccia.
Single-lever shower mixer (only built-in components).



X30LE
Solo parte esterna miscelatore monocomando incasso doccia.
Single-lever shower mixer (only external components).



N09B
Solo parte interna miscelatore monocomando incasso vasca/doccia con deviatore.
Single-lever bath/shower mixer with diverter (only built-in components).



X09LE
Solo parte esterna miscelatore monocomando incasso vasca/doccia con deviatore.
Single-lever bath/shower mixer with diverter (only external components).



X92
Miscelatore monocomando per doccia con deviatore a 2 posizioni su piastra unica.
Single-lever shower mixer, with 2 positions diverter on single flange.



X93
Miscelatore monocomando per doccia con deviatore a 3 vie e 3 posizioni (una entrata e tre uscite) su unica piastra.
Single lever built-in shower mixer with 3 ways diverter and 3 positions (1 inlet and 3 outlets) on single flange.



X94
Miscelatore monocomando per doccia, con deviatore a 4 posizioni (4 uscite ed 1 entrata) su piastra unica.
Single-lever shower mixer with 4 positions diverter (4 outlets and 1 inlet,) on single flange.



X95
Miscelatore monocomando per doccia, con deviatore a 5 posizioni (5 uscite ed una entrata) su piastra unica.
Single-lever shower mixer with 5 positions diverter (5 outlets and 1 inlet) on single flange.



X96
Miscelatore e deviatore su piastre separate.
Built-in shower mixer with diverter on double flange.



X30Q
Miscelatore doccia incasso completo.
Complete built-in shower mixer.



X09Q
Miscelatore doccia incasso con deviatore completo.
Complete built-in bath/shower mixer with diverter.



N30B
Solo parte interna miscelatore monocomando incasso doccia.
Single-lever shower mixer (only built-in components).



X30QE
Solo parte esterna miscelatore monocomando incasso doccia.
Single-lever shower mixer (only external components).



N09B
Solo parte interna miscelatore monocomando incasso vasca/doccia con deviatore.
Single-lever bath/shower mixer with diverter (only built-in components).



X09QE
Solo parte esterna miscelatore monocomando incasso vasca/doccia con deviatore.
Single-lever bath/shower mixer with diverter (only external components).





X92Q

Miscelatore monocomando per doccia con deviatore a 2 posizioni su piastra unica.
Single-lever shower mixer, with 2 positions diverter on single flange.



X93Q

Miscelatore monocomando per doccia con deviatore a 3 vie e 3 posizioni (una entrata e tre uscite) su unica piastra.
Single lever built-in shower mixer with 3 ways diverter and 3 positions (1 inlet and 3 outlets) on single flange.



X94Q

Miscelatore monocomando per doccia, con deviatore a 4 posizioni (4 uscite ed 1 entrata) su piastra unica.
Single-lever shower mixer with 4 positions diverter (4 outlets and 1 inlet,) on single flange.



X95Q

Miscelatore monocomando per doccia, con deviatore a 5 posizioni (5 uscite ed una entrata) su piastra unica.
Single-lever shower mixer with 5 positions diverter (5 outlets and 1 inlet) on single flange.



BOX INCASSO - BUILT-IN BOX MIXERS



RRBOX

Box da incasso per miscelatore doccia con deviatore.
Built-in box for shower mixer with diverter.

+



X30KB

Set miscelatore doccia da abbinare al box incasso.
Shower mixer set to match with the built-in box.

OPPURE
OR



X09KB

Set miscelatore doccia con deviatore da abbinare al box incasso.
Shower mixer set with diverter to match with the built-in box.



RRBOX92

Box da incasso per miscelatore doccia due vie.
Built-in box for two ways shower mixer.

+



X92KB

Set miscelatore doccia due vie da abbinare al box incasso.
Two ways shower mixer set to match with the built-in box.



RRBOX93

Box da incasso per miscelatore doccia tre vie.
Built-in box for three ways shower mixer.

+



X93KB

Set miscelatore doccia tre vie da abbinare al box incasso.
Three ways shower mixer set to match with the built-in box.





RRBOX
Box da incasso per miscelatore doccia con deviatore.
Built-in box for shower mixer with diverter.

+



X30QKB
Set miscelatore doccia da abbinare al box incasso.
Shower mixer set to match with the built-in box.

OPPURE
OR



X09QKB
Set miscelatore doccia con deviatore da abbinare al box incasso.
Shower mixer set with diverter to match with the built-in box.



RRBOX92
Box da incasso per miscelatore doccia due vie.
Built-in box for two ways shower mixer.

+



X92QKB
Set miscelatore doccia due vie da abbinare al box incasso.
Two ways shower mixer set to match with the built-in box.



RRBOX93
Box da incasso per miscelatore doccia tre vie.
Built-in box for three ways shower mixer.

+



X93QKB
Set miscelatore doccia tre vie da abbinare al box incasso.
Three ways shower mixer set to match with the built-in box.



COLONNE DOCCIA - SHOWER COLUMNS

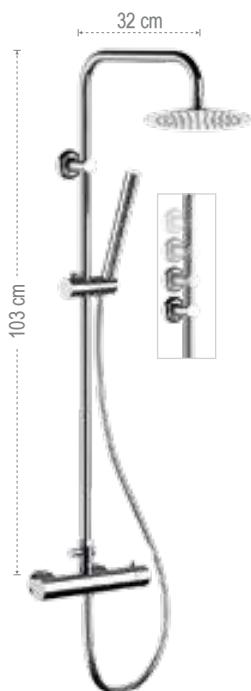

X37X7MMUFM20
Set doccia composto da: miscelatore esterno con attacco superiore, soffione in acciaio inox Ø 20 cm 357UFM20X, colonna doccia con fissaggio superiore regolabile in altezza, con deviatore 330X, doccetta minimale in ottone, 1 funzione 317MM, flessibile 150 cm.
Shower set including: exposed mixer with upper connection, stainless steel Ø 20cm shower head 357UFM20X, shower column with height-adjustable upper fixing and diverter 330X, 1-function brass hand shower 317MM, 150 cm flexible hose.



X37A7MMUFM20
Set doccia composto da: miscelatore esterno con attacco superiore, soffione in acciaio inox Ø 20 cm 357UFM20X, colonna doccia in ottone telescopica, altezza asta regolabile, con deviatore 330A, doccetta minimale in ottone, 1 funzione 317MM, flessibile 150 cm.
Shower set including: exposed mixer with upper connection, stainless steel Ø 20cm shower head 357UFM20X, telescopic brass shower column, with height-adjustable rod, with diverter 330A, 1-function brass hand shower 317MM, 150 cm flexible hose.



WELLNESS



X09S01

Set doccia composto da: miscelatore a incasso con deviatore, soffione in acciaio inox Ø 20 cm 357UFM20X, braccio in ottone 30 cm, saliscendi minimale 317M, presa acqua a muro, doccetta minimale in ottone, 1 funzione 317MM, flessibile 150 cm.

Shower set including: built-in mixer with diverter, stainless steel Ø 20cm shower head 357UFM20X, brass arm 30 cm, minimal sliding rail 317M, wall water connection, 1-function brass hand shower 317MM, 150 cm flexible hose.

X09S01UFM25

Soffione Ø 25 cm.
Shower head Ø 25 cm.

X09S01UFM30

Soffione Ø 30 cm.
Shower head Ø 30 cm.



X09S02

Set doccia composto da: miscelatore a incasso con deviatore, soffione in acciaio inox Ø 20 cm 357UFM20X, braccio in ottone 30 cm, presa acqua a muro con supporto doccetta, doccetta minimale in ottone, 1 funzione 317MM, flessibile 150 cm.

Shower set including: built-in mixer with diverter, stainless steel Ø 20cm shower head 357UFM20X, brass arm 30 cm, wall water connection with shower holder, 1-function brass hand shower 317MM, 150 cm flexible hose.

X09S02UFM25

Soffione Ø 25 cm.
Shower head Ø 25 cm.

X09S02UFM30

Soffione Ø 30 cm.
Shower head Ø 30 cm.



X96S02

Set doccia composto da: miscelatore a incasso orizzontale con deviatore, soffione in acciaio inox Ø 20 cm 357UFM20X, braccio in ottone 30 cm, presa acqua a muro con supporto doccetta, doccetta minimale in ottone, 1 funzione 317MM, flessibile 150 cm.

Shower set including: horizontal built-in mixer with diverter, stainless steel Ø 20cm shower head 357UFM20X, brass arm 30 cm, wall water connection with shower holder, 1-function brass hand shower 317MM, 150 cm flexible hose.

X96S02UFM25

Soffione Ø 25 cm.
Shower head Ø 25 cm.

X96S02UFM30

Soffione Ø 30 cm.
Shower head Ø 30 cm.

X STYLE

Q DESIGN

MINIMAL

QUBIKA

QUBIKA CASCATA

CON OPZIONI DI FINITURA WITH FINISHING OPTIONS



X09S010

Set doccia composto da: miscelatore a incasso con deviatore, soffione in ottone Ø 20 cm 359MM20X, braccio in ottone 30 cm, saliscendi in ottone 317G, presa acqua a muro, doccetta minimale in ottone, 1 funzione 317MM, flessibile 150 cm.

Shower set including: built-in mixer with diverter, brass shower head Ø 20 cm 359MM20X, brass arm 30 cm, brass sliding rail 317G, wall water connection, 1-function brass hand shower 317MM, 150 cm flexible hose.



X09S020

Set doccia composto da: miscelatore a incasso con deviatore, soffione in ottone Ø 20 cm 359MM20X, braccio in ottone 30 cm, presa acqua a muro con supporto doccetta, doccetta minimale in ottone, 1 funzione 317MM, flessibile 150 cm.

Shower set including: built-in mixer with diverter, brass shower head Ø 20 cm 359MM20X, brass arm 30 cm, wall water connection with shower holder, 1-function brass hand shower 317MM, 150 cm flexible hose.



X96S020

Set doccia composto da: miscelatore a incasso orizzontale con deviatore, soffione in ottone Ø 20 cm 359MM20X, braccio in ottone 30 cm, presa acqua a muro con supporto doccetta, doccetta minimale in ottone, 1 funzione 317MM, flessibile 150 cm.

Shower set including: horizontal built-in mixer with diverter, brass shower head Ø 20 cm 359MM20X, brass arm 30 cm, wall water connection with shower holder, 1-function brass hand shower 317MM, 150 cm flexible hose.

Q DESIGN

Q DESIGN



Q-DESIGN è una collezione di rubinetteria monocomando caratterizzata da un design totalmente squadrato e da un forte impatto moderno. La base quadrata del miscelatore si sviluppa intorno a una cartuccia dal diametro di 25 mm e si interseca a bocca e leva rettangolari di spessore minimo. La collezione dispone di numerose soluzioni sia da appoggio che da parete per inserirsi con naturale eleganza in ogni progetto d'arredo.

Q-DESIGN is a single-lever faucet collection characterized by a totally squared design and by a strong modern impact. The square base of the mixer is developed on a cartridge with a diameter of 25 mm and is intersected by rectangular spout and lever of minimum thickness. The collection has numerous solutions both as stand and built-in to naturally fit into any furnishing project.



X STYLE

Q DESIGN

MINIMAL

QUBIKA

QUBIKA CASCATA



▲
NPO nichel spazzolato opaco
matt brushed nickel

▲
NO nero opaco
matt black

Q DESIGN

OPZIONI DI FINITURA

Questa collezione di rubinetteria è disponibile con diverse opzioni di finitura, scegli il colore perfetto per il tuo progetto di arredo! Rispondendo alle esigenze stilistiche dei progetti più ambiziosi, Remer Rubinetterie ha selezionato colori alternativi, oltre al cromato, studiati per arricchire, personalizzare e differenziare gli interni di bagno e cucina.

[Per confermare la propria scelta, aggiungere il codice della finitura al termine del codice prodotto durante la fase di acquisto.]

Q DESIGN

FINISHING OPTIONS

This faucet collection is available with different finishing options, choose the perfect color to customize your interior! Responding to the stylistic needs of the most ambitious designs, Remer Rubinetterie selected alternative colors, in addition to chrome, to enrich, customize and differentiate bathroom and kitchen interiors.

[To confirm your choice, add the finishing code at the end of the item code during the purchase phase.]



X STYLE

Q DESIGN

MINIMAL

QUBIKA

QUBIKA CASCATA

BG oro spazzolato
brushed gold

BO bianco opaco
matt white

CR

 cromo
chrome

CR

FIN 1

 nero opaco
matt black NO

 bianco opaco
matt white BO

 nichel spazzolato
brushed nickel NP

 nichel spazzolato opaco
matt brushed nickel NPO

FIN 2

 cromo nero spazzolato
brushed black chrome CFP

 oro spazzolato
brushed gold BG

LAVABI E BIDET - WASHBASINS AND BIDET MIXERS



Miscelatore monocomando lavabo.
Single-lever basin mixer.

QD10

con scarico quadrato.
with squared pop-up waste.



QD11

senza scarico.
without waste.



QD12

senza scarico e senza foro sul corpo.
without waste and without body hole.



Miscelatore monocomando lavabo medio.
Medium single-lever basin mixer.

QD10A

con scarico quadrato.
with squared pop-up waste.



QD11A

senza scarico.
without waste.



QD12A

senza scarico e senza foro sul corpo.
without waste and without body hole.



Miscelatore monocomando lavabo alto L.
L high single-lever basin mixer.

QD10L

con scarico quadrato click-clack con troppopieno.
with squared click-clack waste and overflow.



QD11L

senza scarico.
without waste.

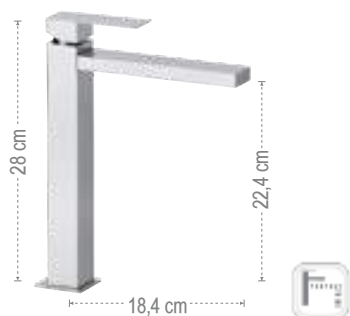

Miscelatore monocomando lavabo alto LXL.
Single-lever LXL high washbasin mixer.

QD10LXL

con scarico quadrato click-clack con troppopieno.
with squared click-clack waste and overflow.



QD11LXL

senza scarico.
without waste.



QD10LXXL

Miscelatore monocomando lavabo alto LXXL con scarico quadrato click-clack con troppopieno.
Single-lever LXXL high washbasin mixer with squared click-clack waste with overflow.

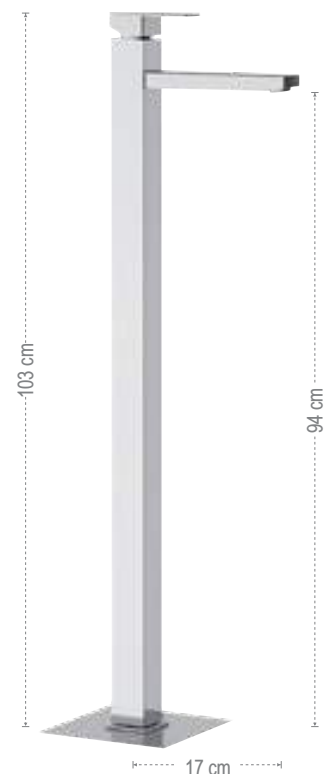

QD18

Miscelatore monocomando lavabo da pavimento con scarico quadrato click-clack con troppopieno.
Single-lever mixer floor mounting with squared click-clack waste with overflow.



91ZC

Bocca incasso con getto a cascata.
Built-in spout with waterfall jet.

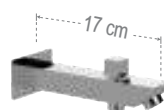

91QD

Bocca incasso con deviatore integrato.
Built-in spout with diverter.





QD15
Miscelatore monocomando a incasso per lavabo, con piastra rettangolare.
Single-lever built-in basin mixer, with rectangular wall flange.

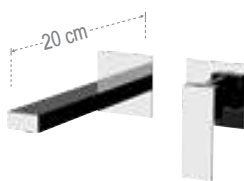

QD15P
Miscelatore monocomando a incasso per lavabo.
Single-lever built-in basin mixer.



QD15C
Miscelatore lavabo da incasso.
Single-lever built-in basin mixer, in chrome plated brass.



QD15L
Lunghezza bocca 23cm.
Spout length 23cm.



QD15PL
Lunghezza bocca 23cm.
Spout length 23cm.



91Q
Bocca incasso.
Built-in spout.



Miscelatore monocomando bidet.
ingle-lever bidet mixer with.

QD20
con scarico quadrato.
with squared pop-up waste.



91QL
Lunghezza bocca 23cm.
Spout length 23cm.



QD21
senza scarico.
without waste.

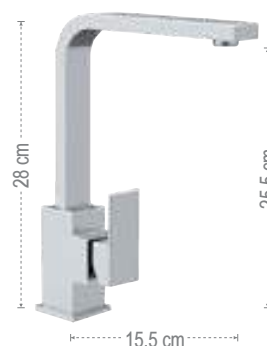

QD10G
Miscelatore monocomando per lavabo con canna a "U" girevole e scarico click-clack quadrato con troppopieno.
Single-lever one-hole sink mixer with "U" swivel spout and click-clack waste.



LAVABO BOX INCASSO - BUILT-IN BOX WASHBASIN MIXER



QD15KB
Miscelatore monocomando a incasso per lavabo, con piastra in ottone, da abbinare al box incasso.
Single-lever built-in basin mixer, with wall flange in brass, to match with the built-in box.



QD15LKB
Lunghezza bocca 23cm.
Spout length 23cm.



RRBOX15
Box da incasso per miscelatore monocomando a incasso per lavabo.
Built-in box for single-lever built-in basin mixer.

MISCELATORI VASCA - BATH MIXERS

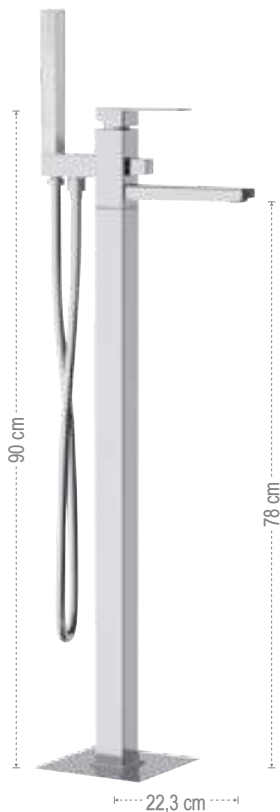

QD08

Miscelatore vasca da pavimento con deviatore, doccetta ad 1 funzione in ottone e flessibile 150 cm.
Free standing bath mixer floor mounting with diverter, 1 function handshower and flexible hose 150 cm.



QD04

Miscelatore monocomando vasca da incasso, flessibile 150 cm e doccetta ad 1 funzione, tutto in ottone.
Single-lever bath mixer with wall flange, 1 function handshower and 150 cm flexible hose all in brass.



Miscelatore vasca esterno.
Exposed bath mixer.

QD02

con kit doccia, flessibile 150 cm e doccetta ad una funzione in ottone.
with shower kit, flexible 150 cm and one function brass minimal handshower.



QD05

senza kit doccia.
without shower kit.



Z07

Miscelatore monocomando bordo vasca con deviatore integrato nella bocca e doccetta estraibile in ottone.
Single lever deck bath/shower mixer with integrated diverter on the spout and pull-out brass handshower.



91ZCA

Bocca bordo vasca.
Spout for deck bath/shower.



91ZCF

Bocca bordo vasca.
Spout for deck bath/shower.

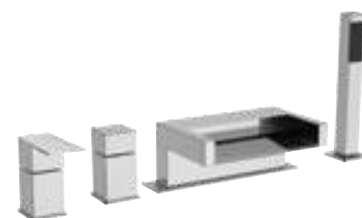

ZC06

Miscelatore monocomando bordo vasca con deviatore, doccetta estraibile in ottone e bocca a cascata.
Single-lever deck bath/shower mixer with diverter, pull-out brass handshower and waterfall spout.



ZC06

X STYLE

Q DESIGN

MINIMAL

QUBIKA

QUBIKA CASCATA

SALISCENDI E COLONNE DOCCIA - SLIDING RAILS & SHOWER COLUMN



QD37

Set doccia composto da: miscelatore esterno doccia, colonna doccia quadra con saliscendi e deviatore, doccetta 1 funzione in ottone cromato 317SS; soffione 20x20 cm in ottone 359SSX; flessibile 150 cm.

Shower set including: exposed shower mixer, square shower column with sliding rail and diverter, 1-function hand shower in chromed brass 317SS; 20x20 cm brass shower head 359SSX; flexible hose 150 cm.



317R317RR

Saliscendi e doccetta tutto in ottone serie ultrapiatta rettangolare minimale lusso, flessibile 150 cm.

Deluxe sliding rail and handshower ultrathin series, rectangular minimal, all in brass, flexible hose 150 cm.



INCASSI DOCCIA - SHOWER MIXERS

**QD30**

Miscelatore monocomando a incasso per doccia completo.
Complete single lever built-in shower mixer.

**QD09**

Miscelatore monocomando a incasso con deviatore per vasca/doccia completo.
Complete single lever built-in bath/shower mixer with diverter.

**N30B**

Solo parte interna miscelatore monocomando incasso doccia.
Single-lever shower mixer (only built-in components).

**QD30E**

Solo parte esterna miscelatore monocomando incasso doccia.
Single-lever shower mixer (only external components).

**N09B**

Solo parte interna miscelatore monocomando incasso vasca/doccia con deviatore.
Single-lever bath/shower mixer with diverter (only built-in components).

**QD09E**

Solo parte esterna miscelatore monocomando incasso vasca/doccia con deviatore.
Single-lever bath/shower mixer with diverter (only external components).

**Z92**

Miscelatore monocomando per doccia con deviatore a 2 posizioni su piastra unica.
Single-lever shower mixer, with 2 positions diverter on single flange.

**Z93**

Miscelatore monocomando per doccia con deviatore a 3 vie e 3 posizioni (una entrata e tre uscite) su unica piastra.
Single lever built-in shower mixer with 3 ways diverter and 3 positions (1 inlet and 3 outlets) on single flange.

**Z94**

Miscelatore monocomando per doccia, con deviatore a 4 posizioni (4 uscite ed 1 entrata) su piastra unica.
Single-lever shower mixer with 4 positions diverter (4 outlets and 1 inlet,) on single flange.

**Z95**

Miscelatore monocomando per doccia, con deviatore a 5 posizioni (5 uscite ed una entrata) su piastra unica.
Single-lever shower mixer with 5 positions diverter (5 outlets and 1 inlet) on single flange.



BOX INCASSO - BUILT-IN BOX MIXERS

X STYLE

Q DESIGN

MINIMAL

QUBIKA

QUBIKA CASCATA



RRBOX
Box da incasso per miscelatore doccia con deviatore.
Built-in box for shower mixer with diverter.

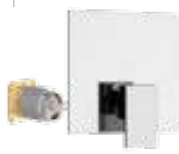

Z30KB
Set miscelatore doccia da abbinare al box incasso.
Shower mixer set to match with the built-in box.

OPPURE
OR

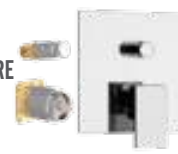

Z09KB
Set miscelatore doccia con deviatore da abbinare al box incasso.
Shower mixer set with diverter to match with the built-in box.



RRBOX92
Box da incasso per miscelatore doccia due vie.
Built-in box for two ways shower mixer.



Z92KB
Set miscelatore doccia due vie da abbinare al box incasso.
Two ways shower mixer set to match with the built-in box.



RRBOX93
Box da incasso per miscelatore doccia tre vie.
Built-in box for three ways shower mixer.



Z93KB
Set miscelatore doccia tre vie da abbinare al box incasso.
Three ways shower mixer set to match with the built-in box.

OPPURE
OR



Z937KB
Set miscelatore doccia tre vie e sette posizioni da abbinare al box incasso.
Three ways and seven positions shower mixer set to match with the built-in box.



CUCINA
KITCHEN MIXERS



QD42U
Miscelatore monocomando per lavello, con bocca alta a "U" girevole.
Single-lever one-hole sink mixer, with high "U" swivel spout.



ACQUA DEPURATA
PURIFIED WATER MIXER

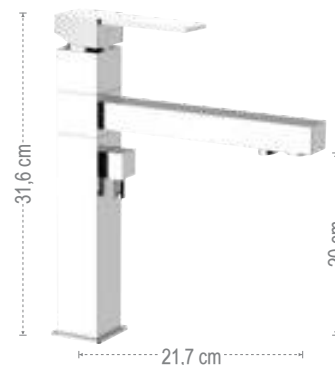

Q40DW
Miscelatore quadrato per lavello a tre vie di ingresso con bocca girevole, selezione acqua potabile tramite la leva e 2 aeratori in uscita.
Three-ways inlet squared single-lever sink mixer with swivel spout, selection for drinking water directly from the lever and 2 outlet aerators



MINIMAL

MINIMAL



Elegante e raffinata, la linea Minimal si pone come icona del nuovo millennio in termini di modernità estetica e costruttiva. L'interpretazione modello di forme completamente arrotondate viene interrotta dal taglio obliquo della bocca di erogazione e dal particolare della maniglia che, piegandosi leggermente all'insù, ci porta a visioni di rinnovata positività. Questa rubinetteria si posiziona sicuramente tra i classici del moderno. La serie è dotata di cartuccia a dischi ceramici Ø 35 mm.

Elegant and refined, the Minimal line stands as an icon of the new millennium in terms of aesthetic and constructive modernity. The model interpretation of fully rounded forms is interrupted by the oblique cut of the spout and by the handle particular that, slightly bending upward, brings us a renewed vision of positivity. This taps series is indeed positioned between the classics of modern. The series is equipped with a Ø 35 mm ceramic disc cartridge.



X STYLE

Q DESIGN

MINIMAL

QUBIKA

QUBIKA CASCATA

MINIMAL

OPZIONI MANIGLIA

La collezione è disponibile con due varianti di maniglia. Selezionare la preferenza al momento dell'ordine.

LEVER OPTIONS

The collection is available with two lever options. Select your preference before ordering.



LAVABI - WASHBASIN MIXERS



Miscelatore monocomando lavabo.
Single-lever basin mixer.

N10
con scarico.
with pop-up waste.



N11
senza scarico.
without waste.



Miscelatore monocomando lavabo, bocca lunga.
Single-lever basin mixer, long spout.

N10A
con scarico.
with pop-up waste.



N11A
senza scarico.
without waste.



Miscelatore monocomando lavabo alto LXL, su colonna.
Single-lever basin mixer, LXL high neck.

N10LXL
con scarico.
with pop-up waste.



N10LXLB
con scarico click-clack con troppopieno senza foro sul corpo.
with click-clack waste and overflow, without body hole.



N11LXL
senza scarico senza foro sul corpo.
without waste and body hole.



Miscelatore monocomando lavabo alto L, su colonna.
Single-lever basin mixer, L high neck.

N10L
con scarico.
with pop-up waste.



N10LB
con scarico click-clack con troppopieno senza foro sul corpo.
with click-clack waste and overflow, without body hole.



N11L
senza scarico senza foro sul corpo.
without waste and body hole.

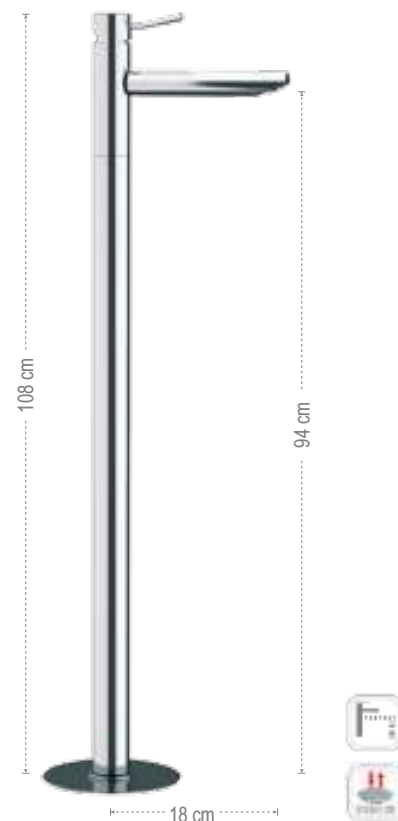

N18
Miscelatore monocomando lavabo da terra con scarico click-clack con troppopieno.
Single-lever mixer for floor mounting with click-clack waste with overflow.



N57
Miscelatore monocomando lavabo due fori senza scarico.
Two holes single-lever washbasin mixer without waste.

LAVABO BOX INCASSO - BUILT-IN BOX WASHBASIN MIXER



N15
Miscelatore monocomando a incasso con piastra rettangolare in ottone e bocca minimal 18 cm.
Single lever built-in basin mixer with rectangular wall flange in brass and minimal spout length 18 cm.



N15KB
Miscelatore monocomando a incasso per lavabo, con piastra in ottone, da abbinare al box incasso.
Single-lever built-in basin mixer, with wall flange in brass, to match with the built-in box.



RRBOX15
Box da incasso per miscelatore monocomando a incasso per lavabo.
Built-in box for single-lever built-in basin mixer.

X STYLE

Q DESIGN

MINIMAL

QUBIKA

QUBIKA CASCATA

BOCCHE - SPOUTS



91NC
Bocca incasso cascata con bordi arrotondati.
Waterfall built-in spout with rounded corners.



91M
Bocca incasso per miscelatore vasca/doccia.
Built-in spout for bath-shower mixer.



91MD
Bocca incasso per miscelatore vasca/doccia, con deviatore integrato.
Built-in spout for bath-shower mixer, with diverter.



91NCF
Bocca bordo vasca con effetto multigetto ed angoli arrotondati.
Spout for deck bath/shower multijets effect and rounded corners.



91N2
Bocca incasso per miscelatore vasca-doccia.
Built-in spout for bath-shower mixer.



N17PROL10CR
Prolunga per Miscelatore da soffitto lunghezza 10 cm, Ø 35 mm, in ottone modello N17, N17L, NR17, NR17L.
Extension for Ceiling mixer length 10 cm, Ø 35 mm, in chrome plated brass for model N17, N17L, NR17, NR17L.

BIDET - BIDET MIXERS



Miscelatore monocomando per bidet, con aeratore direzionabile.
Single-lever bidet mixer with adjustable aerator.

N20
con scarico.
with pop-up waste.



N21
senza scarico.
without waste.



Miscelatore incasso per shut-off con supporto doccia/presa acqua integrato, attacco conico da 1/2", tutto in ottone.
Built-in shower mixer with integrated shower holder/water punch on flange all in brass, with 1/2 connection.

N65
con doccetta shut-off e flessibile cm 120.
with shut-off and flexible hose cm 120.



N65B
senza kit doccia.
without shower kit.



N64W
Miscelatore shut-off con cartuccia progressiva, apertura su acqua fredda e passaggio ad acqua calda tramite rotazione di maniglia unica, comprensivo di doccetta shut-off e flessibile doccia cm 120.
Shut-off mixer with progressive cartridge, opening with cold water, switching on hot water by rotating one single handle including shut-off and flexible hose 120 cm.



N60
Miscelatore incasso per shut-off comprensivo di: doccetta shut-off, supporto doccia/presa acqua su piastra in ottone e flessibile doccia cm 120.
Built-in shut-off mixer set including: shut.off, shower holder water punch on flange, all in brass and flexible hose cm 120.



N63
Miscelatore incasso per shut-off.
Built-in shut-off mixer.

VASCA - BATH MIXER



N06317MM
Miscelatore monocomando bordo vasca con deviatore, bocca con effetto multigetto e doccetta estraibile ad 1 funzione in ottone.
Single lever deck bath/shower mixer with diverter, spout with multijets effect and pull-out 1 function brass handshower.



N04
Miscelatore monocomando a incasso per vasca, su piastra rettangolare, con bocca lunga cm 18, deviatore e kit doccia integrato.
Single-lever built-in bath mixer, with rectangular wall flange, spout long 18 cm with diverter and integrated shower kit.



Miscelatore vasca esterno.
Exposed bath mixer.

N02
con flessibile 150 cm con supporto snodato e doccetta ad 1 funzione in ABS anticalcare.
with flexible hose 150 cm with swivel shower holder and 1 function antilimestone ABS handshower.



N05
senza kit doccia.
without shower kit.



N07
 Miscelatore monocomando bordo vasca con deviatore a leva integrato nella bocca minimale e doccetta estraibile.
Single lever deck bath/shower mixer with lever diverter integrated on the spout, with spout and hand pull-out shower.



N27
 Miscelatore bordo vasca con deviatore integrato nel miscelatore e doccetta estraibile minimale.
Single lever bath deck mixer with diverter integrated on the mixer and pull-out minimal handshower.



N03
 Miscelatore monocomando lavabo/vasca, con deviatore integrato, flessibile 150 cm con supporto snodato e doccetta ad 1 funzione in ABS anticalcare.
Single lever basin/bath mixer with diverter, flexible hose 150 cm with swivel shower holder and 1 function antilimestone ABS handshower.

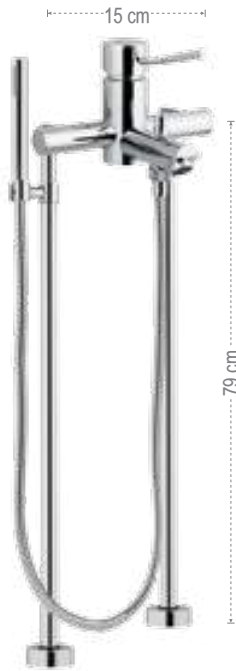

N02XL
 Gruppo vasca esterno su colonne da pavimento Minimal, con flessibile 150 cm e doccetta ad 1 funzione in ABS anticalcare.
Traditional bathtub mixer, on Minimal floor columns, with shower kit, flexible 150 cm with 1 function antilimestone ABS handshower.

88N02
 Coppia colonne vasca in ottone, serie Minimal, con supporto doccia, 3/4M x 3/4M.
Couple brass vertical connections for bath mixer, serie Minimal, with handshower holder 3/4M x 3/4M.

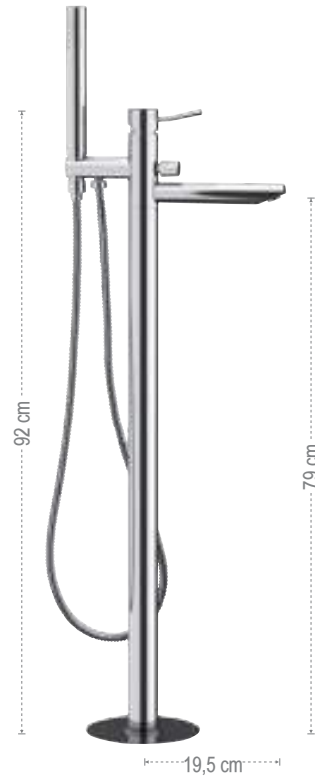

N08
 Miscelatore vasca da pavimento con deviatore e kit doccia, senza scarico.
Single-lever bath mixer floor mounting with diverter and shower kit.

X STYLE

Q DESIGN

MINIMAL

QUBIKA

QUBIKA CASCATA

DOCCE - SHOWER MIXERS



317M317MD

Saliscendi minimale con doccetta anticalcare.
Minimal sliding rail set with antilimestone handshower.



Miscelatore monocomando esterno doccia.
Wall mounted single-lever shower mixer.

N39

con flessibile 150 cm con supporto snodato e doccetta ad 1 funzione in ABS anticalcare.
with flexible hose 150 cm with swivel shower holder and 1 function antilimestone ABS handshower.



N31

senza kit doccia.
without shower kit.



N35R

Gruppo doccia a muro minimale, con attacco superiore per colonna da 3/4.
Minimal wall mounted shower mixer, with 3/4 upper connection.

INCASSI - BUILT-IN MIXERS



N30

Miscelatore monocomando a incasso per doccia completo.
Complete single lever built-in shower mixer.

N30B

Solo parte interna miscelatore monocomando incasso doccia.
Single-lever shower mixer (only built-in components).

N30E

Solo parte esterna miscelatore monocomando incasso doccia.
Single-lever shower mixer (only external components).



N09

Miscelatore monocomando a incasso con deviatore per vasca/doccia completo.
Complete single lever built-in bath/shower mixer with diverter.

N09B

Solo parte interna miscelatore monocomando incasso vasca/doccia con deviatore.
Single-lever bath/shower mixer with diverter (only built-in components).

N09E

Solo parte esterna miscelatore monocomando incasso vasca/doccia con deviatore.
Single-lever bath/shower mixer with diverter (only external components).



N30L

Miscelatore monocomando a incasso per doccia completo, con piastra lusso.
Complete single lever built-in shower mixer, with deluxe flange.

N30B

Solo parte interna miscelatore monocomando incasso doccia.
Single-lever shower mixer (only built-in components).

N30LE

Solo parte esterna miscelatore monocomando incasso doccia, con piastra lusso.
Single-lever shower mixer (only external components), with deluxe flange.



N09L

Miscelatore monocomando a incasso con deviatore per vasca/doccia completo, con piastra lusso.
Complete single lever built-in bath/shower mixer with diverter, with deluxe flange.

N09B

Solo parte interna miscelatore monocomando incasso vasca/doccia con deviatore.
Single-lever bath/shower mixer with diverter (only built-in components).

N09LE

Solo parte esterna miscelatore monocomando incasso vasca/doccia con deviatore, con piastra lusso.
Single-lever bath/shower mixer with diverter (only external components), with deluxe flange.



N92
Miscelatore monocomando a incasso per doccia, con deviatore a due posizioni (due uscite ed una entrata) su piastra unica.
Single-lever built-in shower mixer with 2 positions diverter (2 outlets and 1 inlet) on single flange.



N93
Miscelatore monocomando per doccia con deviatore a tre vie (una entrata e tre uscite) su unica piastra.
Single lever built-in shower mixer with three ways diverter (1 inlet and 3 outlets) on single flange.



N937
Miscelatore monocomando per doccia con deviatore a tre vie e sette posizioni (una entrata, tre uscite e sette posizioni con cui selezionare uscite singole o miscelate tra loro) su unica piastra.
Single lever built-in shower mixer with three ways diverter with seven positions (1 inlet and 3 outlets and seven positions to select single or mixed outlets) on single flange.



N94
Miscelatore monocomando per doccia, con deviatore a 4 posizioni (4 uscite ed 1 entrata) su piastra unica.
Single-lever shower mixer with 4 positions diverter (4 outlets and 1 inlet) on single flange.



N95
Miscelatore monocomando per doccia, con deviatore a 5 posizioni (5 uscite ed una entrata) su piastra unica.
Single-lever shower mixer with 5 positions diverter (5 outlets and 1 inlet) on single flange.



N94C
Miscelatore monocomando per doccia, con deviatore a 4 posizioni (4 uscite ed una entrata) su doppia piastra.
Single-lever shower mixer with 4 positions diverter (4 outlets and 1 inlet) on double flange.



N95C
Miscelatore monocomando per doccia, con deviatore a 5 posizioni (5 uscite ed una entrata) su doppia piastra.
Single-lever shower mixer with 5 positions diverter (5 outlets and 1 inlet) on double flange.



X STYLE

Q DESIGN

MINIMAL

QUBIKA

QUBIKA CASCATA

BOX INCASSO - BUILT-IN BOX MIXERS



RRBOX
Box da incasso per miscelatore doccia con deviatore.
Built-in box for shower mixer with diverter.

+



N30KB
Set miscelatore doccia da abbinare al box incasso.
Shower mixer set to match with the built-in box.

OPPURE
OR



N 09 KB
Set miscelatore doccia con deviatore da abbinare al box incasso.
Shower mixer set with diverter to match with the built-in box.



RRBOX92
Box da incasso per miscelatore doccia due vie.
Built-in box for two ways shower mixer.

+



N92KB
Set miscelatore doccia due vie da abbinare al box incasso.
Two ways shower mixer set to match with the built-in box.



RRBOX93
Box da incasso per miscelatore doccia tre vie.
Built-in box for three ways shower mixer.

+



N93KB
Set miscelatore doccia tre vie da abbinare al box incasso.
Three ways shower mixer set to match with the built-in box.



OPPURE
OR



N937KB
Set miscelatore doccia tre vie e sette posizioni da abbinare al box incasso.
Three ways and seven positions shower mixer set to match with the built-in box.



COLONNE DOCCIA - SHOWER COLUMNS



N37R

Set doccia composto da: miscelatore esterno con attacco superiore, soffione in ottone Ø 20 cm 359MM20X, colonna doccia in ottone con deviatore 330U, doccetta in abs, 1 funzione 317MD, flessibile 150 cm.

Shower set including: exposed mixer with upper connection, brass shower head Ø 20 cm 359MM20X, brass swivel shower column with diverter 330U, 1-function abs hand shower 317MD, 150 cm flexible hose.

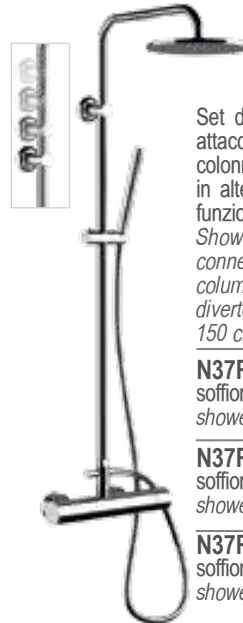

Set doccia composto da: miscelatore esterno con attacco superiore, soffione in abs 356MD20X, colonna doccia con fissaggio superiore regolabile in altezza, con deviatore 330X, doccetta in abs, 1 funzione 317MD, flessibile 150 cm.

Shower set including: exposed mixer with upper connection, abs shower head 356MD20X, shower column with height-adjustable upper fixing and diverter 330X, 1-function abs hand shower 317MD, 150 cm flexible hose.

N37RXMD20

soffione Ø 20 cm.
shower head Ø 20 cm.

N37RXMD25

soffione Ø 25 cm.
shower head Ø 25 cm.

N37RXMD30

soffione Ø 30 cm.
shower head Ø 30 cm.

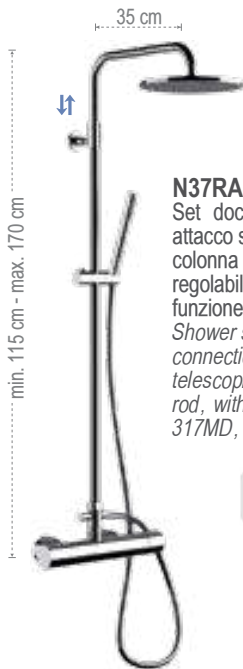

N37RAMD20

Set doccia composto da: miscelatore esterno con attacco superiore, soffione in abs Ø 20 cm 356MD20X, colonna doccia in ottone telescopica, altezza asta regolabile, con deviatore 330A, doccetta in abs, 1 funzione 317MD, flessibile 150 cm.

Shower set including: exposed mixer with upper connection, abs Ø 20 cm shower head 356MD20X, telescopic brass shower column, with height-adjustable rod, with diverter 330A, 1-function abs hand shower 317MD, 150 cm flexible hose.

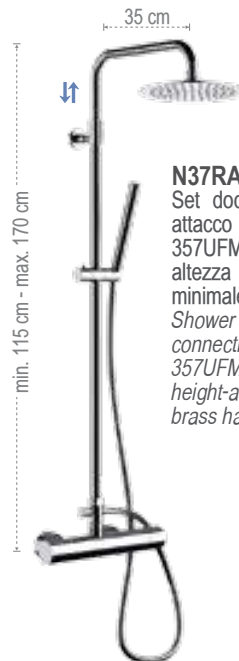

N37RA7MMUFM20

Set doccia composto da: miscelatore esterno con attacco superiore, soffione in acciaio inox Ø 20 cm 357UFM20X, colonna doccia in ottone telescopica, altezza asta regolabile, con deviatore 330A, doccetta minimale in ottone, 1 funzione 317MM, flessibile 150 cm.

Shower set including: exposed mixer with upper connection, stainless steel Ø 20cm shower head 357UFM20X, telescopic brass shower column, with height-adjustable rod, with diverter 330A, 1-function brass hand shower 317MM, 150 cm flexible hose.



COLONNE PISCINA - POOL COLUMNS

**331N52**

Colonna free-standing con miscelatore acqua calda-fredda, con attacco da pavimento tutta in ottone, minimale rotonda con soffione anticalcare in ottone Ø 30 cm.

Free-standing chrome plated brass column with single lever mixer hot/cold water control, with brass antilimestone shower head Ø 30 cm.



331N52

X STYLE

Q DESIGN

MINIMAL

QUBIKA

QUBIKA CASCATA



Set doccia composto da: miscelatore a incasso con deviatore, soffione in acciaio inox 357UFM20X, braccio in ottone 30 cm, presa acqua a muro con supporto doccetta, doccetta minimale in ottone, 1 funzione 317MM, flessibile 150 cm.

Shower set including: built-in mixer with diverter, stainless steel Ø 20cm shower head 357UFM20X, brass arm 30 cm, wall water connection with shower holder, 1-function brass hand shower 317MM, 150 cm flexible hose.



N09S02UFM20

con soffione doccia ultrapiatto Ø20 cm, con braccio 30 cm.
with Ø20 cm ultraslim shower head with arm cm 30.

N09S02UFM25

con soffione doccia ultrapiatto Ø25 cm, con braccio 30 cm.
with Ø25 cm ultraslim shower head with arm cm 30.

N09S02UFM30

con soffione doccia ultrapiatto Ø30 cm, con braccio 30 cm.
with Ø30 cm ultraslim shower head with arm cm 30.

N09S02UFM40

con soffione doccia ultrapiatto Ø40 cm, con braccio 40 cm.
with Ø40 cm ultraslim shower head with arm cm 40.



Set doccia composto da: miscelatore a incasso con deviatore, soffione in acciaio inox 357UFM20X, braccio in ottone 30 cm, saliscendi minimale 317M, presa acqua a muro, doccetta minimale in ottone, 1 funzione 317MM, flessibile 150 cm.

Shower set including: built-in mixer with diverter, stainless steel shower head 357UFM20X, brass arm 30 cm, minimal sliding rail 317M, wall water connection, 1-function brass hand shower 317MM, 150 cm flexible hose.



N09S01UFM20

con soffione doccia Ø20 cm e braccio 30 cm.
with Ø20 cm shower head and arm cm 30.

N09S01UFM25

con soffione doccia Ø25 cm e braccio 30 cm.
with Ø25 cm shower head and arm cm 30.

N09S01UFM30

con soffione doccia Ø30 cm e braccio 30 cm.
with Ø30 cm shower head and arm cm 30.

N09S01UFM40

con soffione doccia Ø40 cm e braccio 40 cm.
with Ø40 cm shower head and arm cm 40.



N94S02UFMCA

Set doccia composto da: miscelatore a incasso con deviatore a 4 vie, soffione a parete in acciaio inox con getto a pioggia e cascata 350UFMCA, presa acqua a muro con supporto doccetta, doccetta minimale in ottone, 1 funzione 317MM, 6 getti tondi, flessibile 150 cm.

Shower set including: built-in mixer with 4-way diverter, wall mounted stainless steel shower head with rain and waterfall functions 350UFMCA, wall water connection with shower holder, 1-function brass hand shower 317MM, 6 round body jets, 150 cm flexible hose.



Set doccia composto da: miscelatore a incasso con deviatore a 3 vie e 7 posizioni, soffione in acciaio inox 357UFM20X, braccio in ottone 30 cm, presa acqua a muro con supporto doccetta, doccetta minimale in ottone, 1 funzione 317MM, 6 getti tondi, flessibile 150 cm.

Shower set including: built-in mixer with 3-way and 7-position diverter, stainless steel Ø 20cm shower head 357UFM20X, brass arm 30 cm, wall water connection with shower holder, 1-function brass hand shower 317MM, 6 round body jets, 150 cm flexible hose.



N937S01UFM20

con soffione doccia ultrapiatto Ø20 cm, con braccio 30 cm.
with Ø20 cm ultraslim shower head with arm cm 30.

N937S01UFM25

con soffione doccia ultrapiatto Ø25 cm, con braccio 30 cm.
with Ø25 cm ultraslim shower head with arm cm 30.

N937S01UFM30

con soffione doccia ultrapiatto Ø30 cm, con braccio 30 cm.
with Ø30 cm ultraslim shower head with arm cm 30.

N937S01UFM40

con soffione doccia ultrapiatto Ø40 cm, con braccio 40 cm.
with Ø40 cm ultraslim shower head with arm cm 40.



N09S02UFM

Set doccia composto da: miscelatore a incasso con deviatore, soffione a parete in acciaio inox con getto a pioggia 350UFMX, presa acqua a muro con supporto doccetta, doccetta minimale in ottone, 1 funzione 317MM, flessibile 150 cm.

Shower set including: built-in mixer with diverter, wall-mounted stainless steel shower head with rain jet 350UFMX, wall water connection with shower holder, 1-function brass hand shower 317MM, 150 cm flexible hose.



N937S02UFMCA

Set doccia composto da: miscelatore a incasso con deviatore a 3 vie e 7 posizioni, soffione a parete in acciaio inox con getto a pioggia e cascata 350UFMCA, presa acqua a muro con supporto doccetta, doccetta minimale in ottone, 1 funzione 317MM, flessibile 150 cm.

Shower set including: built-in mixer with 3-way and 7-position diverter, wall mounted stainless steel shower head with rain and waterfall functions 350UFMCA, wall water connection with shower holder, 1-function brass hand shower 317MM, 150 cm flexible hose.



N09S02

Set doccia composto da: miscelatore a incasso con deviatore, soffione in abs Ø 24 cm 356LUX, braccio in ottone 30 cm, presa acqua a muro con supporto doccetta, doccetta in abs, 1 funzione 317MD, flessibile 150 cm.

Shower set including: built-in mixer with diverter, abs Ø 24 cm shower head 356LUX, brass arm 30 cm, wall water connection with shower holder, 1-function abs hand shower 317MD, 150 cm flexible hose.



N09S01

Set doccia composto da: miscelatore a incasso con deviatore, soffione in abs Ø 24 cm 356LUX, braccio in ottone 30 cm, saliscendi minimale 317M, presa acqua a muro, doccetta in abs, 1 funzione 317MD, flessibile 150 cm.

Shower set including: built-in mixer with diverter, abs Ø 24 cm shower head 356LUX, brass arm 30 cm, minimal sliding rail 317M, wall water connection, 1-function abs hand shower 317MD, 150 cm flexible hose.



CUCINA - KITCHEN MIXERS



N40
Miscelatore monocomando per lavello, con bocca girevole.
Single-lever one-hole sink mixer, with swivel spout.



N40L
Miscelatore monocomando per lavello, con bocca girevole.
Single-lever one-hole sink mixer, with swivel body.

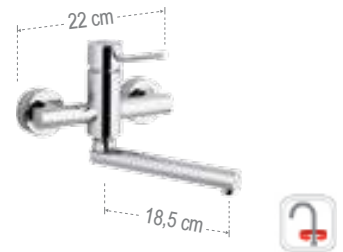

N41
Miscelatore monocomando per lavello a muro, con bocca girevole lunghezza 20 cm.
Single-lever wall mounted sink mixer, with swivel spout length 20 cm.

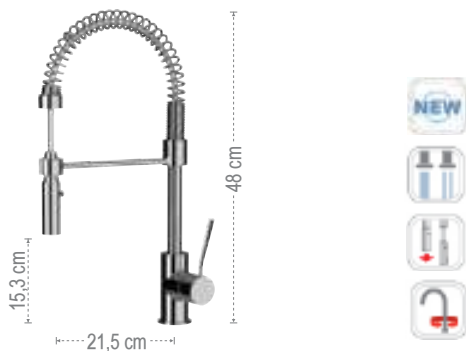

N77E
Miscelatore monocomando lavello a molla con doccetta estraibile ed orientabile a due funzioni e cartuccia Ø 35.
Spring single-lever sink mixer with pull-out and swivelling 2 functions handshower and Ø 35 mm cartridge.

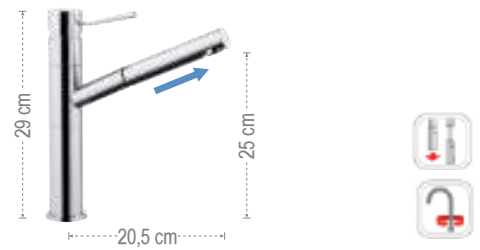

N47
Miscelatore monocomando per lavello, con bocca estraibile e girevole.
Single-lever one-hole sink mixer, with pull-out spray jet shower with swivel spout.



N48319MO
Miscelatore monocomando bordo lavello con deviatore a leva integrato nella bocca minimale e doccetta cromata minimale estraibile a 4 funzioni anticalcare.
Single lever deck sink mixer with integrated lever diverter on spout, pull-out handshower 4 functions with antilimestone.



N48332EU
Miscelatore monocomando bordo lavello con deviatore a leva integrato nella bocca minimale e doccetta estraibile a pulsante minimale in ABS, cromata con impugnatura liscia 1/2".
Single lever deck sink mixer with integrated lever diverter on spout, pull-out c.p. ABS minimal shut-off, with plain handgrip 1/2".



X STYLE

Q DESIGN

MINIMAL

QUBIKA

QUBIKA CASCATA



CUCINA ACQUA POTABILE - KITCHEN DRINKING WATER MIXERS

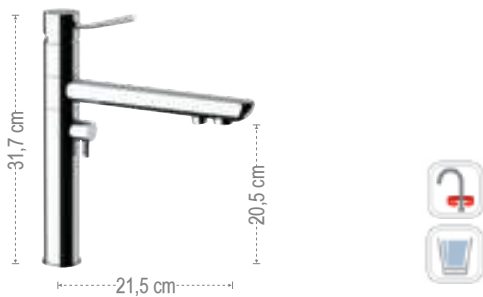

N40DW

Miscelatore lavello Minimale a tre vie di ingresso con bocca girevole, con selezione acqua potabile tramite la leva, con due vie d'uscita completamente indipendenti.

Three ways inlet minimal single lever sink mixer, with swivel spout, with selection for drinking water directly from the lever and two fully independent outlets.



N792DW

Miscelatore lavello serie Minimal a tre vie di ingresso con bocca girevole e due vie d'uscita completamente indipendenti, con selezione acqua potabile tramite la leva.

Three ways inlet minimal series single lever sink mixer, with swivel spout and two fully independent outlets, with selection for drinking water directly from the lever.

QUBIKA

QUBIKA



Il design di QUBIKA ha un carattere elegante ed una bellezza immediata. La base quadrata viene armonicamente intersecata dalle bocche rettangolari di spessore minimo. Ogni singolo componente si lega al precedente in un gioco di angoli vivi che scolpiscono l'oggetto e ne delineano le caratteristiche di essenzialità e forte impatto estetico. Una serie dalla modernità spiccata e minimale. La serie è dotata di cartuccia a dischi ceramici Ø 35 mm.

The design of QUBIKA has an elegant character and an immediate beauty. The square base is harmonically intersected by the rectangular spouts of minimum thickness. Each single component is in harmony with the previous one in a game of sharp angles sculpting the object and delineating the characteristics of simplicity and strong visual impact. A series of high and minimal modernity. The series is equipped with a Ø 35 mm ceramic disc cartridge



X STYLE

Q DESIGN

MINIMAL

QUBIKA

QUBIKA CASCATA

LAVABI - WASHBASIN MIXERS

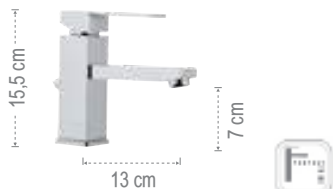

Miscelatore monocomando lavabo.
Single-lever basin mixer.

Q10
con scarico quadrato
with squared pop-up waste.

Q11
senza scarico.
without waste.



Q15
Miscelatore monocomando a incasso per lavabo, con piastra rettangolare in ottone e bocca Qubika.
Single lever built-in basin mixer, with rectangular wall flange in chrome plated brass and Qubika spout.

Q15L
Lunghezza bocca 23 cm.
Spout length 23cm.



Q57
Miscelatore monocomando lavabo due fori, senza scarico.
Two holes single-lever washbasin mixer without waste.



Miscelatore monocomando lavabo alto L.
Single-lever basin mixer L high neck.

Q10L
con scarico quadrato click-clack con troppopieno.
with squared click-clack waste with overflow.

Q10LB
con scarico quadrato click-clack.
with squared click-clack waste.

Q11L
senza scarico senza foro sul corpo.
without waste and body hole.



Miscelatore monocomando lavabo extra alto XXL.
Single-lever basin mixer XXL high.

Q10LXXL
con scarico quadrato click-clack con troppopieno.
with squared click-clack waste with overflow.

Q11LXXL
senza scarico senza foro sul corpo.
without waste and body hole.



Miscelatore monocomando lavabo extra alto XL.
Single-lever basin mixer extra high XL neck.

Q10LXL
con scarico quadrato click-clack con troppopieno.
with squared click-clack waste with overflow.

Q11LXL
senza scarico senza foro sul corpo.
without waste and body hole.

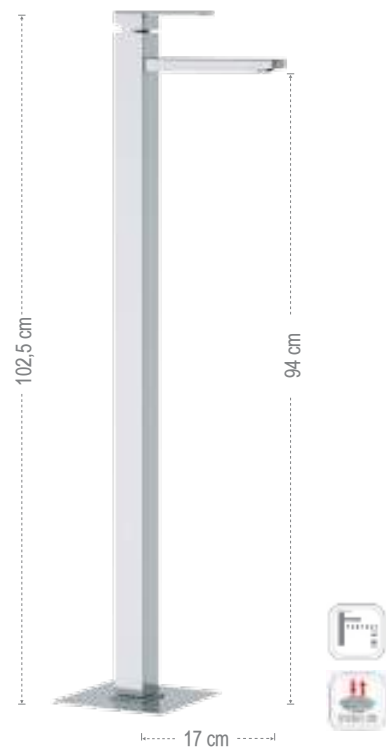

Q18
Miscelatore monocomando lavabo da pavimento, con scarico click-clack quadrato con troppo pieno.
Single-lever basin mixer floor mounting with squared click-clack waste with overflow.



Q10G
Miscelatore monocomando lavabo, con canna corta a "U" e scarico click-clack quadrato con troppo pieno.
Single-lever one-hole sink mixer, with short "U" spout, with squared click-clack waste with overflow.



Q10GL
Miscelatore monocomando lavabo alto L, con canna corta a "U", e scarico click-clack quadrato con troppo pieno.
L high single-lever one-hole sink mixer, with short "U" spout, with squared click-clack waste with overflow.



Q10GLXL
Miscelatore monocomando lavabo alto XL, con canna lunga a "U" con scarico click-clack quadrato con troppo pieno.
XL high single-lever one-hole sink mixer, with long "U" spout, with squared click-clack waste with overflow.

X STYLE

Q DESIGN

MINIMAL

QUBIKA

QUBIKA CASCATA

LAVABO BOX INCASSO - BUILT-IN BOX WASHBASIN MIXER



Q15KB
Miscelatore monocomando a incasso per lavabo, con piastra in ottone da abbinare al box incasso.
Single-lever built-in basin mixer, with wall flange in chrome plated brass to match with the built-in box.

RRBOX15
Box da incasso per miscelatore monocomando a incasso per lavabo.
Built-in box for single-lever built-in basin mixer.

BOCCHE - SPOUT

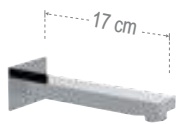

91Q
Bocca incasso.
Built-in spout.

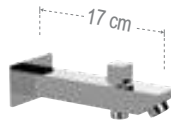

91QD
Bocca incasso, con deviatore integrato.
Built-in spout, with diverter.



91Q2
Bocca incasso.
Built-in spout.



91ZCA
Bocca bordo vasca getto a cascata.
Spout for deck bath/shower with waterfall jet.



91ZCF
Bocca bordo vasca con effetto multigetto.
Spout for deck bath/shower with multijets effect.



91ZC
Bocca a muro con getto cascata.
Wall mounted spout, with waterfall jet.

BIDET - BIDET MIXERS



Miscelatore monocomando per bidet, con aeratore direzionabile, tettuccio di protezione.
Single-lever bidet mixer with adjustable aerator, covered and shielded.

Q20
con scarico quadrato.
with squared pop-up waste.



Q21
senza scarico.
without waste.



Miscelatore incasso shut-off con supporto doccia-presa acqua, attacco conico da 1/2" e supporto shut-off, tutto in ottone.
Built-in shut-off mixer set including with water punch on flange, all in brass, with 1/2 connection, handshower support.

Q65
doccetta shut-off e flessibile doccia cm 120.
shut-off and flexible hose cm 120.



Q65B
senza kit doccia.
without shower kit.



Q60
Miscelatore incasso per shut-off comprensivo di: doccetta shut-off, supporto doccia-presa acqua su piastra in ottone e flessibile doccia cm 120.
Built-in shut-off mixer set including: shut-off, shower holder-water punch on flange, all in brass and flexible hose cm 120.



Q23
Miscelatore monocomando per bidet, con getto spray.
Single-lever bidet mixer with spray.



Q63
Miscelatore incasso per shut-off.
Built-in shut-off mixer.

VASCA - BATH MIXERS



Miscelatore vasca esterno.
Exposed bath mixer.

Q02
con flessibile 150 cm, supporto snodato e doccetta anticalcare ad 1 funzione.
with flexible hose 150 cm, swivel shower holder and 1 function antilimestone handshower.



Q05
senza kit doccia.
without shower kit.



Q04
Miscelatore monocomando per vasca da incasso, su piastra rettangolare, bocca lunga cm 18 con deviatore, doccetta anticalcare ad 1 funzione, flessibile 150 cm.
Single-lever bath mixer, with rectangular wall flange, spout long 18 cm with integrated diverter, 1 function antilimestone handshower and flexible hose 150 cm.

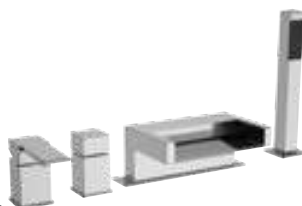

QC06
Miscelatore monocomando bordo vasca con deviatore, bocca cascata e doccetta estraibile in ottone.
Single lever deck bath/shower mixer with diverter, waterfall spout and pull-out brass handshower

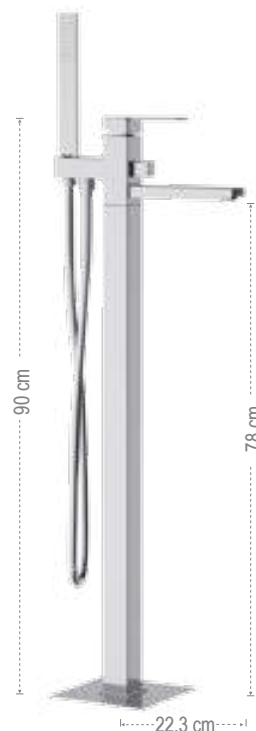

Q08
Miscelatore vasca da pavimento, con deviatore, doccetta anticalcare ad 1 funzione e flessibile 150 cm, senza scarico.
Single-lever bath mixer floor mounting, with diverter, 1 function antilimestone handshower and flexible hose 150 cm.





Q06
Miscelatore monocomando bordo vasca con deviatore, bocca con effetto multigetto e doccetta estraibile in ottone.
Single lever deck bath/shower mixer with diverter, spout with multijets effect and pull-out brass handshower.



Q07
Miscelatore monocomando bordo vasca con deviatore integrato nella bocca quadra e doccetta quadrata estraibile in ottone.
Single-lever deck bath/shower mixer with diverter integrated on the squared spout, and squared chrome plated brass pull-out handshower.



DOCCE - EXPOSED SHOWER MIXERS



Miscelatore monocomando esterno per doccia.
Wall mounted single-lever shower mixer.

Q39
con flessibile 150 cm, supporto snodato e doccetta anticalcare ad 1 funzione.
with flexible hose 150 cm, swivel shower holder and 1 function antilimestone handshower.



317S317SQ
Saliscendi quadro completamente in ottone con doccetta minimale SQ in ABS cromato e flessibile conico in ottone cm 150.
SQ sliding bar completely in brass, with handshower SQ in c.p. ABS and one conical nut flexible hose cm 150.



Q31
senza kit doccia.
without shower kit.

INCASSI - BUILT-IN MIXERS



Q30
Miscelatore monocomando a incasso per doccia completo.
Complete single lever built-in shower mixer.

N30B
Solo parte interna miscelatore monocomando incasso doccia.
Single-lever shower mixer (only built-in components).

Q30E
Solo parte esterna miscelatore monocomando incasso doccia.
Single-lever shower mixer (only external components).



Q09
Miscelatore monocomando a incasso con deviatore per vasca/doccia completo.
Complete single lever built-in bath/shower mixer with diverter.

N09B
Solo parte interna miscelatore monocomando incasso vasca/doccia con deviatore.
Single-lever bath/shower mixer with diverter (only built-in components).

Q09E
Solo parte esterna miscelatore monocomando incasso vasca/doccia con deviatore.
Single-lever bath/shower mixer with diverter (only external components).



Q92
Miscelatore monocomando per doccia, con deviatore a due posizioni (due uscite ed una entrata).
Single-lever shower mixer with 2 positions diverter (2 outlets and 1 inlet).





Q93
Miscelatore monocomando per doccia con deviatore a tre vie (1 entrata e 3 uscite).
Single lever built-in shower mixer with 3 ways diverter (1 inlet and 3 outlets).



Q937
Miscelatore monocomando per doccia con deviatore a 3 vie e 7 posizioni d'uscita (con cui selezionare uscite singole o combiate).
Single lever built-in shower mixer with 3 ways diverter and 7 positions (to select single or combined outlets).



Q94
Miscelatore monocomando per doccia, con deviatore a 4 posizioni (4 uscite ed 1 entrata).
Single-lever shower mixer with 4 positions diverter (4 outlets and 1 inlet).



Q95
Miscelatore monocomando per doccia, con deviatore a 5 posizioni (5 uscite ed una entrata).
Single-lever shower mixer with 5 positions diverter (5 outlets and 1 inlet).



Q94C
Miscelatore monocomando per doccia, con deviatore a 4 posizioni (4 uscite ed 1 entrata).
Single-lever shower mixer with 4 positions diverter (4 outlets and 1 inlet).



Q95C
Miscelatore monocomando per doccia, con deviatore a 5 posizioni (5 uscite ed 1 entrata).
Single-lever shower mixer with 5 positions diverter (5 outlets and 1 inlet).



BOX INCASSO - BUILT-IN BOX MIXERS



RRBOX
Box da incasso per miscelatore doccia con deviatore.
Built-in box for shower mixer with diverter.

+



Q30KB
Set miscelatore doccia da abbinare al box incasso.
Shower mixer set to match with the built-in box.

OPPURE
OR



Q09KB
Set miscelatore doccia con deviatore da abbinare al box incasso.
Shower mixer set with diverter to match with the built-in box.



RRBOX92
Box da incasso per miscelatore doccia due vie.
Built-in box for two ways shower mixer.

+



Q92KB
Set miscelatore doccia due vie da abbinare al box incasso.
Two ways shower mixer set to match with the built-in box.



RRBOX93
Box da incasso per miscelatore doccia tre vie.
Built-in box for three ways shower mixer.

+



Q93KB
Set miscelatore doccia tre vie da abbinare al box incasso.
Three ways shower mixer set to match with the built-in box.



OPPURE
OR



Q937KB
Set miscelatore doccia tre vie e sette posizioni da abbinare al box incasso.
Three ways and seven positions shower mixer set to match with the built-in box.



COLONNE DOCCIA - SHOWER COLUMN

X STYLE

Q DESIGN

MINIMAL

QUBIKA

QUBIKA CASCATA



Q37

Set doccia composto da: miscelatore esterno doccia, colonna doccia quadra con saliscendi e deviatore 330S, doccetta in abs a 1 funzione 317SQ, soffione in ottone 20x20 cm 359SSX, flessibile 150 cm.

Shower set including: external shower mixer, square shower column with sliding rail and diverter 330S, 1-function abs handshower 317SQ, 20x20 cm brass shower head 359SSX, flexible hose 150 cm.



Q37XL

Set doccia composto da: miscelatore esterno con attacco superiore, soffione in ottone 35x35cm 359SSXLX, colonna doccia quadrata in ottone con deviatore 330S, doccetta in abs a 1 funzione 317SQ, flessibile 150 cm.

Shower set including: exposed mixer with upper connection, brass shower head 35x35cm 359SSXLX, square brass shower column with diverter 330S, 1-function abs hand shower 317SQ, 150 cm flexible hose.



WELLNESS



Set doccia composto da: miscelatore a incasso con deviatore, soffione in acciaio inox 357UFS20X, braccio quadrato in ottone 30 cm, saliscendi piatto in ottone 317R, presa acqua a muro, doccetta piatta in ottone a 1 funzione 317RR, flessibile 150 cm.

Shower set including: built-in mixer with diverter, stainless steel shower head 357UFS20X, square brass arm 30 cm, flat brass sliding rail 317R, wall water connection, 1-function brass flat hand shower 317RR, 150 cm flexible hose.



Q09S01UFS20

con soffione ultrapiatto 20x20 cm e braccio doccia 30 cm.
with ultraslim shower head 20x20 cm and shower arm 30 cm.

Q09S01UFS25

con soffione ultrapiatto 25x25 cm e braccio doccia 30 cm.
with ultraslim shower head 25x25 cm and shower arm 30 cm.

Q09S01UFS30

con soffione ultrapiatto 30x30 cm e braccio doccia 30 cm.
with ultraslim shower head 30x30 cm and shower arm 30 cm.

Q09S01UFS40

con soffione ultrapiatto 40x40 cm e braccio doccia 30 cm.
with ultraslim shower head 40x40 cm and shower arm 30 cm.

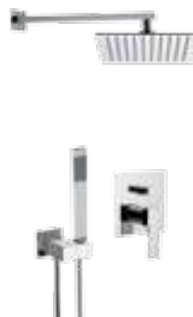

Set doccia composto da: miscelatore a incasso con deviatore, soffione in acciaio inox 357UFS20X, braccio quadrato in ottone 30 cm, presa acqua a muro con supporto doccetta, doccetta piatta in ottone a 1 funzione 317RR, flessibile 150 cm.

Shower set including: built-in mixer with diverter, stainless steel shower head 357UFS20X, square brass arm 30 cm, wall water connection with shower holder, 1-function brass flat hand shower 317RR, 150 cm flexible hose.



Q09S02UFS20

con soffione ultrapiatto 20x20 cm e braccio doccia 30 cm.
with ultraslim shower head 20x20 cm and shower arm 30 cm.

Q09S02UFS25

con soffione ultrapiatto 25x25 cm e braccio doccia 30 cm.
with ultraslim shower head 25x25 cm and shower arm 30 cm.

Q09S02UFS30

con soffione ultrapiatto 30x30 cm e braccio doccia 30 cm.
with ultraslim shower head 30x30 cm and shower arm 30 cm.

Q09S02UFS40

con soffione ultrapiatto 40x40 cm e braccio doccia 30 cm.
with ultraslim shower head 40x40 cm and shower arm 30 cm.



Q09S01SS

Set doccia composto da: miscelatore a incasso con deviatore, soffione a parete in acciaio inox con getto a pioggia 350SSX, saliscendi piatto in ottone 317R, presa acqua a muro, doccetta piatta in ottone a 1 funzione 317RR, flessibile 150 cm.
 Shower set including: built-in mixer with diverter, wall-mounted stainless steel shower head with rain jet 350SSX, flat brass sliding rail 317R, wall water connection, 1-function brass flat hand shower 317RR, 150 cm flexible hose.



Q09S02SS

Set doccia composto da: miscelatore a incasso con deviatore, soffione a parete in acciaio inox con getto a pioggia 350SSX, presa acqua a muro con supporto doccetta, doccetta piatta in ottone a 1 funzione 317RR, flessibile 150 cm.
 Shower set including: built-in mixer with diverter, wall-mounted stainless steel shower head with rain jet 350SSX, wall water connection with shower holder, 1-function brass flat hand shower 317RR, 150 cm flexible hose.



Q09S01

Set doccia composto da: miscelatore a incasso con deviatore, soffione in ottone 20x20cm 359SSX, braccio quadrato in ottone 30 cm, saliscendi quadrato in ottone 317S, presa acqua a muro, doccetta in abs a 1 funzione 317SQ, flessibile 150 cm.
 Shower set including: built-in mixer with diverter, brass shower head 20x20cm 359SSX, square brass arm 30 cm, square brass sliding rail 317S, wall water connection, 1-function abs hand shower 317SQ, 150 cm flexible hose.

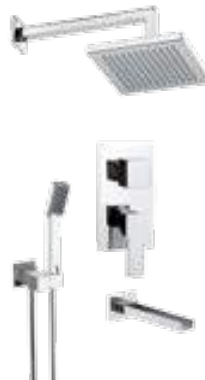

QC937S03

Set doccia composto da: miscelatore a incasso con deviatore a 3 vie e 7 posizioni, soffione in ottone 20x20cm 359SSX, braccio quadrato in ottone 30 cm, bocca a incasso con cascata, presa acqua a muro con supporto doccetta orientabile, doccetta in abs a 1 funzione 317SQ, flessibile 150 cm.
 Shower set including: built-in mixer with 3-way and 7-position diverter, brass shower head 20x20cm 359SSX, square brass arm 30 cm, built-in spout, wall water connection with adjustable shower holder, 1-function abs hand shower 317SQ, 150 cm flexible hose.



Set doccia composto da: miscelatore a incasso con deviatore a 3 vie e 7 posizioni, soffione in acciaio inox 357UFS20X, braccio quadrato in ottone 30 cm, presa acqua a muro con supporto doccetta, doccetta piatta in ottone a 1 funzione 317RR, 6 getti quadrati, flessibile 150 cm.
 Shower set including: built-in mixer with 3-way and 7-position diverter, stainless steel shower head 357UFS20X, square brass arm 30 cm, wall water connection with shower holder, 1-function brass flat hand shower 317RR, 6 square body jets, 150 cm flexible hose.



Q94S02SSCA

Set doccia composto da: miscelatore a incasso con deviatore a 4 vie, soffione a parete in acciaio inox con getto a pioggia e cascata 350SSCAX, presa acqua a muro con supporto doccetta, doccetta piatta in ottone a 1 funzione 317RR, 6 getti quadrati, flessibile 150 cm.
 Shower set including: built-in mixer with 4-way diverter, wall mounted stainless steel shower head with rain and waterfall functions 350SSCAX, wall water connection with shower holder, 1-function brass flat hand shower 317RR, 6 square body jets, 150 cm flexible hose..



Q937S02UFS20

con soffione ultrapiatto 20x20 cm e braccio doccia 30 cm.
 with ultraslim shower head 20x20 cm and shower arm 30 cm.

Q937S02UFS25

con soffione ultrapiatto 25x25 cm e braccio doccia 30 cm.
 with ultraslim shower head 25x25 cm and shower arm 30 cm.

Q937S02UFS30

con soffione ultrapiatto 30x30 cm e braccio doccia 30 cm.
 with ultraslim shower head 30x30 cm and shower arm 30 cm.

Q937S02UFS40

con soffione ultrapiatto 40x40 cm e braccio doccia 40 cm.
 with ultraslim shower head 40x40 cm and shower arm 40 cm.



X STYLE

Q DESIGN

MINIMAL

QUBIKA

QUBIKA CASCATA

Q09S02SS



Q937S01SSCA

Set doccia composto da: miscelatore a incasso con deviatore a 3 vie e 7 posizioni, soffione in acciaio inox con getto a pioggia e cascata 350SSCAX, saliscendi piatto in ottone 317R, presa acqua a muro, doccetta piatta in ottone a 1 funzione 317RR, flessibile 150 cm.

Shower set including: built-in mixer with 3-way and 7-position diverter, wall mounted stainless steel shower head with rain and waterfall functions 350SSCAX, flat brass sliding rail 317R, wall water connection, 1-function brass flat hand shower 317RR, 150 cm flexible hose.



Q937S02SSCA

Set doccia composto da: miscelatore a incasso con deviatore a 3 vie e 7 posizioni, soffione a parete in acciaio inox con getto a pioggia e cascata 350SSCAX, presa acqua a muro con supporto doccetta, doccetta piatta in ottone a 1 funzione 317RR, flessibile 150 cm.

Shower set including: built-in mixer with 3-way and 7-position diverter, wall mounted stainless steel shower head with rain and waterfall functions 350SSCAX, wall water connection with shower holder, 1-function brass flat hand shower 317RR, 150 cm flexible hose.



Set doccia composto da: miscelatore a incasso con deviatore, soffione in ottone 20x20cm 359SSX, braccio quadrato in ottone 30 cm, presa acqua a muro con supporto doccetta orientabile, doccetta in abs a 1 funzione 317SQ, flessibile 150 cm.

Shower set including: built-in mixer with diverter, brass shower head 20x20cm 359SSX, square brass arm 30 cm, wall water connection with adjustable shower holder, 1-function abs hand shower 317SQ, 150 cm flexible hose.



Q09S03

Set doccia composto da: miscelatore a incasso con deviatore, soffione in ottone 20x20cm 359SSX, braccio quadrato in ottone 30 cm, bocca a incasso con deviatore, supporto doccetta orientabile, doccetta in abs a 1 funzione 317SQ, flessibile 150 cm.

Shower set including: built-in mixer with diverter, brass shower head 20x20cm 359SSX, square brass arm 30 cm, built-in spout with diverter, adjustable shower holder, 1-function abs hand shower 317SQ, 150 cm flexible hose.



Q09S02

Con braccio doccia a parete quadrato in ottone 30 cm.
With squared wall shower arm all in brass cm 30.

Q09S22

Con braccio doccia a soffitto quadrato in ottone 30 cm.
With ceiling squared shower arm all in brass cm 30.



Set doccia composto da: miscelatore a incasso con deviatore a 3 vie e 7 posizioni, soffione in ottone 20x20cm 359SSX, braccio quadrato in ottone 30 cm, saliscendi quadrato in ottone 317S, presa acqua a muro, doccetta in abs a 1 funzione 317SQ, 6 getti quadrati, flessibile 150 cm.

Shower set including: built-in mixer with 3-way and 7-position diverter, brass shower head 20x20cm 359SSX, square brass arm 30 cm, square brass sliding rail 317S, wall water connection, 1-function abs hand shower 317SQ, 6 square body jets, 150 cm flexible hose.



Set doccia composto da: miscelatore a incasso con deviatore a 3 vie e 7 posizioni, soffione in ottone 20x20cm 359SSX, braccio quadrato in ottone 30 cm, presa acqua a muro con supporto doccetta orientabile, doccetta in abs a 1 funzione 317SQ, 6 getti quadrati, flessibile 150 cm.

Shower set including: built-in mixer with 3-way and 7-position diverter, brass shower head 20x20cm 359SSX, square brass arm 30 cm, wall water connection with adjustable shower holder, 1-function abs hand shower 317SQ, 6 square body jets, 150 cm flexible hose.



Q937S01

Con braccio doccia a parete quadrato in ottone 30 cm.
With squared wall shower arm all in brass cm 30.

Q937S21

Con braccio doccia a soffitto quadrato in ottone 30 cm.
With ceiling squared shower arm all in brass cm 30.

Q937S02

Con braccio doccia a parete quadrato in ottone 30 cm.
With squared wall shower arm in brass cm 30.

Q937S22

Con braccio doccia a soffitto quadrato in ottone 30 cm.
With ceiling squared shower arm in brass cm 30.

CUCINA - KITCHEN MIXERS



Q42U

Miscelatore monocomando per lavello, con bocca alta girevole a "U".
Single-lever one-hole sink mixer, with high "U" spout.

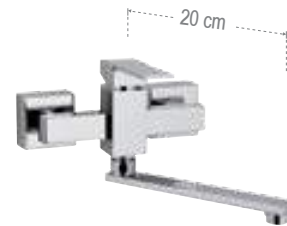

Q41

Miscelatore monocomando esterno per lavello a muro con bocca squadrata.
Single-lever wall mounted sink mixer, with squared spout.

TOUCH-ME



CE

QT42U

Miscelatore monocomando per lavello, con bocca alta girevole a "U", dotata di tecnologia Touch-Me.
Single-lever one-hole sink mixer, with high "U" spout, equipped with Touch-Me system.

ACQUA POTABILE - DRINKING WATER MIXER

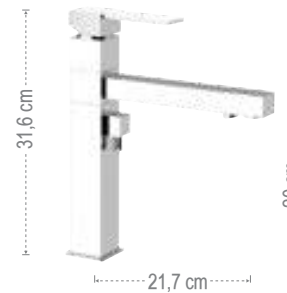

Q40DW

Miscelatore lavello Quadrato a tre vie di ingresso con bocca girevole, con selezione acqua potabile tramite la leva, con due vie d'uscita completamente indipendenti.
Three ways inlet squared single lever sink mixer, with swivel spout, with selection for drinking water directly from the lever, and two fully independent outlets.

X STYLE

Q DESIGN

MINIMAL

QUBIKA

QUBIKA CASCATA



QT42U

QUBIKA CASCATA

QUBIKA CASCATA



Con la sua forza vitale, la cascata è il simbolo di rigenerazione per eccellenza. Il suo scorrere ci riporta in luoghi naturali e accompagna la mente in fantasie e rituali di benessere. QUBKA CASCATA nata sulle linee di Qubika, ci porta in una nuova condizione di relax nell'uso di oggetti del quotidiano, riequilibrando attraverso la freschezza, il suono e la purezza dell'elemento vitale, l'acqua. La serie è dotata di cartuccia a dischi ceramici Ø 35 mm.

With its vital force, the waterfall is a symbol of regeneration for excellence. Its run takes us back to natural places accompanying the mind in wellness fantasies and rituals. QUBIKA CASCATA, born on the lines of Qubika, takes us to a new state of relax in the use of everyday objects, rebalancing us through the freshness, the sound and the pureness of the vital element, water. The series is equipped with a Ø 35 mm ceramic disc cartridge.

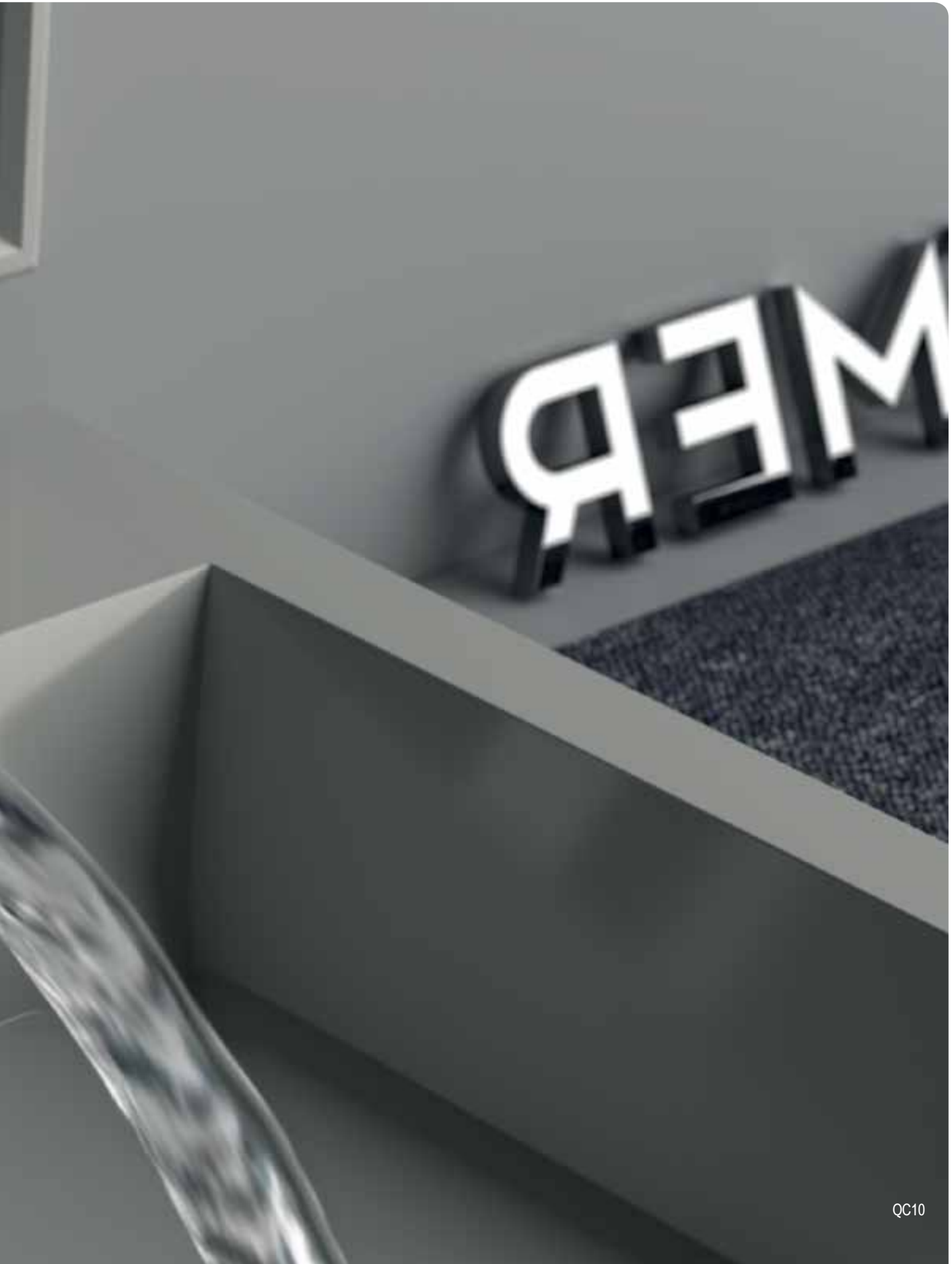

X STYLE

Q DESIGN

MINIMAL

QUBIKA

QUBIKA CASCATA

LAVABI E BIDET - WASHBASIN & BIDET MIXERS



Miscelatore monocomando lavabo bocca a cascata.
Single-lever basin mixer with waterfall spout.

QC10
con scarico quadrato
with squared pop-up waste.



QC11
senza scarico.
without waste.



Miscelatore monocomando lavabo alto L con bocca a cascata.
Single-lever basin mixer L high neck with waterfall spout.

QC10L
con scarico quadrato click-clack
con troppopieno.
*with squared click-clack waste
with overflow.*



QC10LB
con scarico quadrato click-clack
senza troppopieno.
*with squared click-clack waste
without overflow.*



QC11L
senza scarico, senza foro sul corpo.
without waste and body hole.



Miscelatore monocomando lavabo alto XXL con bocca a cascata.
Single-lever basin mixer XXL high neck with waterfall spout.

QC10LXXL
con scarico quadrato click-clack
con troppopieno.
*with squared click-clack waste
with overflow.*



QC11LXXL
senza scarico, senza foro sul corpo.
without waste and body hole.

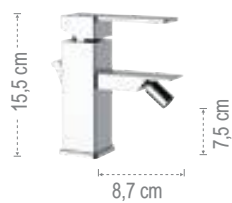

Miscelatore monocomando per bidet, con aeratore direzionabile e tettuccio di protezione.
Single-lever bidet mixer with adjustable aerator and covered and shielded.

Q20
con scarico quadrato
with squared pop-up waste.



Q21
senza scarico.
without waste.

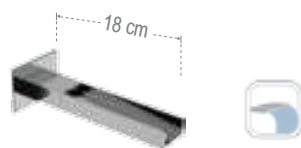

91QC
Bocca incasso a cascata.
Built-in spout with waterfall jet.

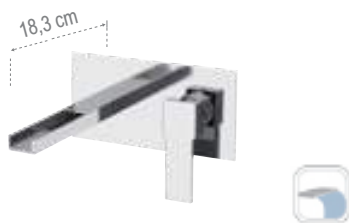

QC15
Miscelatore monocomando a incasso per lavabo, con piastra verticale rettangolare in ottone e bocca a cascata squadrata.
Single lever built-it basin mixer, with rectangular wall flange in chrome plated brass.

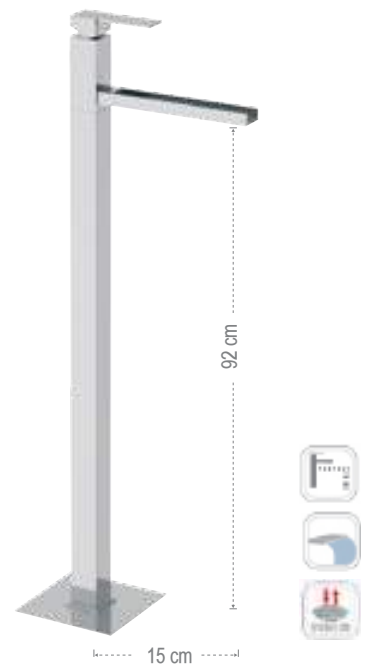

QC18
Miscelatore monocomando lavabo da pavimento, con scarico click-clack con troppo pieno.
Single-lever mixer floor mounting with click-clack with overflow.

X STYLE

Q DESIGN

MINIMAL

QUBIKA

QUBIKA CASCATA



91ZC



91ZC
Bocca incasso a cascata.
Built-in spout with waterfall jet.



91ZCA
Bocca bordo vasca getto cascata.
Spout for deck bath/shower with waterfall jet.



91ZCF
Bocca bordo vasca multigetto.
Spout for deck bath/shower with multijet.

VASCA - BATH MIXERS



Miscelatore monocomando per vasca, esterno, con bocca a cascata.
Single-lever external bath mixer, with waterfall spout.

QC02

con doccetta in ABS anticalcare ad 1 funzione e supporto
snodato flessibile 150 cm.
with 1 function antilimestone ABS handshower
and swivel shower holder, flexible hose 150 cm.



QC05

senza kit doccia.
without shower kit.

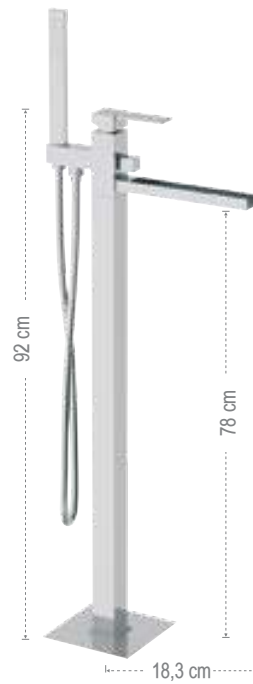

QC08

Miscelatore vasca da pavimento, con doccetta
ad 1 funzione in ottone, bocca a cascata,
deviatore e flessibile 150 cm.
Single-lever bath mixer floor mounting, with 1
function handshower in brass, with waterfall
spout and diverter, flexible hose 150 cm.

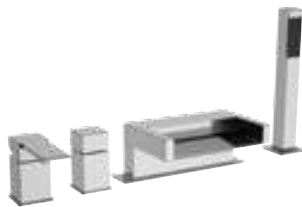

QC06

Miscelatore monocomando bordo vasca con deviatore, bocca cascata e doccetta
estraibile ad 1 funzione in ottone.
Single lever deck bath/shower mixer with diverter, waterfall spout and 1
function pull-out brass handshower.

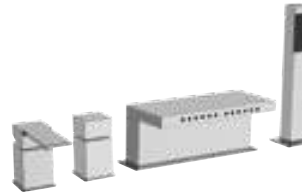

Q06

Miscelatore monocomando bordo vasca con deviatore, bocca con effetto
multigetto e doccetta estraibile ad 1 funzione in ottone.
Single lever deck bath/shower mixer with diverter, spout with multijets effect and 1
function pull-out brass handshower.

WELLNESS



QC937S03

Set doccia composto da: miscelatore a incasso
con deviatore a 3 vie e 7 posizioni, soffione
in ottone 20x20cm 359SSX, braccio quadrato
in ottone 30 cm, bocca a incasso con cascata,
presa acqua a muro con supporto doccetta
orientabile, doccetta in abs a 1 funzione 317SQ,
flessibile 150 cm.
Shower set including: built-in mixer with 3-way
and 7-position diverter, brass shower head 20x20cm
359SSX, square brass arm 30 cm, built-in spout,
wall water connection with adjustable shower
holder, 1-function abs hand shower 317SQ, 150
cm flexible hose.



QC94S03UFCA

Set doccia composto da: miscelatore a incasso
con deviatore a 4 vie, soffione a parete in acciaio
inox con getto a pioggia e cascata 350UFCAX,
bocca a incasso con cascata, presa acqua a
muro con supporto doccetta orientabile, doccetta
in abs a 1 funzione 317SQ, flessibile 150 cm.
Shower set including: built-in mixer with 4-way
diverter, wall mounted stainless steel shower
head with rain and waterfall functions 350UFCAX,
built-in waterfall spout, wall water connection with
adjustable shower holder, 1-function abs hand
shower 317SQ, 150 cm flexible hose.



QC94S03SSCA

Set doccia composto da: miscelatore a incasso
con deviatore a 4 vie, soffione a parete in acciaio
inox con getto a pioggia e cascata 350SSCAX,
bocca a incasso con cascata, presa acqua a
muro con supporto doccetta orientabile, doccetta
in abs a 1 funzione 317SQ, flessibile 150 cm.
Shower set including: built-in mixer with 4-way
diverter, wall mounted stainless steel shower
head with rain and waterfall functions 350SSCAX,
built-in waterfall spout, wall water connection with
adjustable shower holder, 1-function abs hand
shower 317SQ, 150 cm flexible hose.



QC95S04UFCA

Set doccia composto da: miscelatore a incasso con deviatore a 5 vie, soffione a parete in acciaio inox con getto a pioggia e cascata 350UFCAX, saliscendi quadrato in ottone 317S, bocca a incasso con cascata, presa acqua a muro, doccetta in abs a 1 funzione 317SQ, 6 getti quadrati, flessibile 150 cm.
 Shower set including: miscelatore incasso con deviatore a 5 vie, wall mounted stainless steel shower head with rain and waterfall functions 350UFCAX, square brass sliding rail 317S, built-in waterfall spout, wall water connection, 1-function abs hand shower 317SQ, 6 square body jets, 150 cm flexible hose.



QC95S04SSCA

Set doccia composto da: miscelatore a incasso con deviatore a 5 vie, soffione a parete in acciaio inox con getto a pioggia e cascata 350UFCAX, saliscendi quadrato in ottone 317S, bocca a incasso con cascata, presa acqua a muro, doccetta in abs a 1 funzione 317SQ, 6 getti quadrati, flessibile 150 cm.
 Shower set including: miscelatore incasso con deviatore a 5 vie, wall mounted stainless steel shower head with rain and waterfall functions 350UFCAX, square brass sliding rail 317S, built-in waterfall spout, wall water connection, 1-function abs hand shower 317SQ, 6 square body jets, 150 cm flexible hose.

WELLNESS CASCATA TERMOSTATICO - WELLNESS THERMOSTATIC WATERFALL



QTC94S03UFCA

Set doccia composto da: miscelatore termostatico a incasso con deviatore a 4 vie, soffione a parete in acciaio inox con getto a pioggia e cascata 350UFCAX, bocca a incasso con cascata, presa acqua a muro con supporto doccetta orientabile, doccetta in abs a 1 funzione 317SQ, flessibile 150 cm.
 Shower set including: thermostatic built-in mixer with 4-way diverter, wall mounted stainless steel shower head with rain and waterfall functions 350UFCAX, built-in waterfall spout, wall water connection with adjustable shower holder, 1-function abs hand shower 317SQ, 150 cm flexible hose.



QTC94S03SSCA

Set doccia composto da: miscelatore termostatico a incasso con deviatore a 4 vie, soffione a parete in acciaio inox con getto a pioggia e cascata 350SSCAX, bocca a incasso con cascata, presa acqua a muro con supporto doccetta orientabile, doccetta in abs a 1 funzione 317SQ, flessibile 150 cm.
 Shower set including: thermostatic built-in mixer with 4-way diverter, wall mounted stainless steel shower head with rain and waterfall functions 350SSCAX, built-in waterfall spout, wall water connection with adjustable shower holder, 1-function abs hand shower 317SQ, 150 cm flexible hose.

DESIGN

DESIGN MINIMALE - MINIMAL DESIGN

CONTRACT

CLASSICA - CLASSIC

TERMOSTATICI - THERMOSTATICS

SENSOR & TEMPOR

ACCESSORI - ACCESSORIES



TEN

pag. 178



GIGA FOUR

pag. 182



KISS

pag. 186



REMIX

pag. 194



35

pag. 200

TEN



TEN

OPZIONI MANIGLIA

La collezione è disponibile con diverse varianti di maniglia. Selezionare la preferenza al momento dell'ordine.

TEN

LEVER OPTIONS

The collection is available with different lever options. Select your preference before ordering.

La serie è dotata di cartuccia a dischi ceramici Ø 40 mm.

The series is equipped with a Ø 40 mm ceramic disc cartridge.

TEN

GIGA FOUR

KISS

REMIX

35



T10

T10

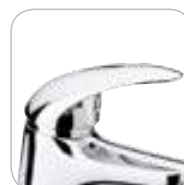

T102

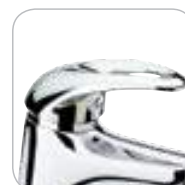

LAVABI E BIDET - WASHBASIN AND BIDET MIXERS



Miscelatore monocomando lavabo.
Single-lever basin mixer.

T10

con scarico.
with pop-up waste.



T11

senza scarico.
without waste.



Miscelatore monocomando lavabo.
Single-lever basin mixer.

T10L

con scarico.
with pop-up waste.



T11L

senza scarico.
without waste.



Miscelatore monocomando per bidet, con aeratore direzionabile.
Single-lever bidet mixer with adjustable aerator.

T20

con scarico.
with pop-up waste.



T21

senza scarico.
without waste.



VASCA - BATH MIXERS



Miscelatore monocomando per vasca, esterno.
Single-lever external bath mixer.

T02

con doccetta in ABS anticalcare ad 1 funzione e supporto snodato flessibile 150 cm.
with 1 function antilimestone ABS handshower and swivel shower holder, flexible hose 150 cm.



T05

senza kit doccia.
without shower kit.



Miscelatore monoforo lavabo/vasca con deviatore integrato.
Single-lever one-hole basin/bath mixer with diverter.

T03

con doccetta in ABS anticalcare ad 1 funzione e supporto snodato, flessibile 150 cm.
with 1 function antilimestone ABS handshower and swivel shower holder, flexible hose 150 cm.



T04

senza kit doccia.
without shower kit.



T07

Miscelatore monocomando bordo vasca con deviatore integrato nella bocca, e doccetta in ABS estraibile con idromassaggio e anticalcare a 4 funzioni.
Single lever deck bath/shower mixer with diverter integrated on the spout, antilimestone pull-out ABS handshower 4 functions.



T07UF

Miscelatore monocomando bordo vasca con deviatore integrato nel miscelatore, bocca effetto cascata e doccetta estraibile in ABS a 4 funzioni anticalcare.
Single lever deck bath/shower mixer with diverter integrated on the mixer, spout with waterfall jet, antilimestone pull-out ABS handshower 4 functions.



DOCCE - SHOWER MIXERS

INCASSI DOCCIA - BUILT-IN MIXERS



311D312
Saliscendi cromato con asta tonda e doccetta in ABS anticalcare.
C.P. sliding rail set with swiveling rail and ABS antilimestone handshower.



T30
Miscelatore monocomando incasso doccia.
Built-in single-lever shower mixer.



T09
Miscelatore monocomando incasso vasca/doccia con deviatore.
Built-in single-lever bath/shower mixer with diverter.

CUCINA - KITCHEN MIXERS



T40
Miscelatore monocomando per lavello, con bocca girevole.
Single-lever one-hole sink mixer, with swivel spout.



T47
Miscelatore monocomando per lavello, con doccia estraibile a getto variabile.
Single-lever one-hole sink mixer, with pull-out spray jet shower, 2 functions.



T42R
Miscelatore monocomando monoforo 90° per lavello, con bocca alta girevole ed abbattibile, tipo lusso, modello sottofinestra.
Single-lever one-hole sink mixer, with high spout swivel and foldable, luxury type, under window type.



T42
Miscelatore monocomando per lavello, con bocca alta girevole, tipo lusso.
Single-lever one-hole sink mixer, with high swivel spout, luxury type.



T42C
Miscelatore monocomando per lavello, con bocca girevole, modello corto, tipo lusso.
Single-lever one-hole sink mixer, with swivel spout, luxury type, shorter model.



T42U
Miscelatore monocomando per lavello, con bocca alta a "U" girevole.
Single-lever one-hole sink mixer, with high "U" swivel spout.



T43
Miscelatore monocomando per lavello a muro, con leva frontale e bocca alta girevole.
Single-lever wall mounted sink mixer, with frontal lever and high swivel spout.



T43C
Miscelatore monocomando per lavello a muro, con leva frontale e bocca girevole modello corto.
Single-lever wall mounted sink mixer, with frontal lever and swivel spout, shorter model.



TEN

GIGA FOUR

KISS

REMIX

35

GIGA FOUR



GIGA FOUR

OPZIONI MANIGLIA

La collezione è disponibile con diverse varianti di maniglia. Selezionare la preferenza al momento dell'ordine.

GIGA FOUR

LEVER OPTIONS

The collection is available with different lever options. Select your preference before ordering.

La serie è dotata di cartuccia a dischi ceramici Ø 40 mm.

The series is equipped with a Ø 40 mm ceramic disc cartridge.



G104

G10



G102

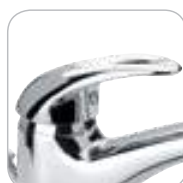

G103

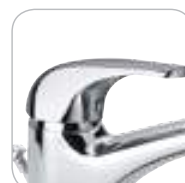

G104

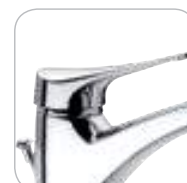

TEN

GIGA FOUR

KISS

REMIX

35

LAVABI E BIDET - WASHBASIN AND BIDET MIXERS



Miscelatore monocomando lavabo.
Single-lever basin mixer.

G104
con scarico.
with pop-up waste.



G114
senza scarico.
without waste.



Miscelatore monocomando per bidet, con aeratore direzionabile.
Single-lever bidet mixer with adjustable aerator.

G204
con scarico.
with pop-up waste.



G214
senza scarico.
without waste.



VASCA - BATH MIXERS



Miscelatore monocomando per vasca, esterno.
Single-lever external bath mixer.

G024
con doccetta in ABS anticalcare ad 1 funzione e supporto snodato flessibile 150 cm.
with 1 function antilimestone ABS handshower and swivel shower holder, flexible hose 150 cm.



G054
senza kit doccia.
without shower kit.



Miscelatore monoforo lavabo/vasca con deviatore integrato.
Single-lever one-hole basin/bath mixer with diverter.

G034
con doccetta in ABS anticalcare ad 1 funzione e supporto snodato, flessibile 150 cm.
with 1 function antilimestone ABS handshower and swivel shower holder, flexible hose 150 cm.



G044
senza kit doccia.
without shower kit.



G074
Miscelatore monocomando bordo vasca con deviatore integrato nella bocca, e doccetta in ABS estraibile con idromassaggio e anticalcare a 4 funzioni.
Single lever deck bath/shower mixer with diverter integrated on the spout, antilimestone pull-out ABS handshower 4 functions.



G074UF
Miscelatore monocomando bordo vasca con deviatore integrato nel miscelatore, bocca effetto cascata e doccetta estraibile in ABS a 4 funzioni anticalcare.
Single lever deck bath/shower mixer with diverter integrated on the mixer, spout with waterfall jet, antilimestone pull-out ABS handshower 4 functions.



DOCCE - SHOWER MIXERS

INCASSI DOCCIA - BUILT-IN MIXERS



Miscelatore monocomando esterno doccia con leva frontale.
Wall mounted single-lever shower mixer with frontal lever.

G384
con doccetta in ABS anticalcare ad 1 funzione e supporto snodato flessibile 150 cm.
with 1 function antilimestone ABS handshower and swivel shower holder, flexible hose 150 cm.



G334
senza kit doccia.
without shower kit.



G304
Miscelatore monocomando incasso doccia.
Built-in single-lever shower mixer.

G094
Miscelatore monocomando incasso vasca/doccia con deviatore.
Built-in single-lever bath/shower mixer with diverter.

CUCINA - KITCHEN MIXERS



G404
Miscelatore monocomando per lavello, con bocca girevole.
Single-lever one-hole sink mixer, with swivel spout.

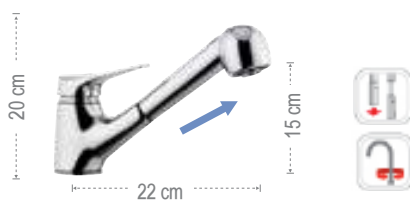

G474
Miscelatore monocomando per lavello, con doccia estraibile a getto variabile.
Single-lever one-hole sink mixer, with pull-out spray jet shower, 2 functions.



G424R
Miscelatore monocomando monoforo 90° per lavello, con bocca alta girevole ed orientabile, tipo lusso, modello sottofinestra.
Single-lever one-hole sink mixer, with high spout swivel and orientable, luxury type, under window type.



G424
Miscelatore monocomando per lavello, con bocca alta girevole, tipo lusso.
Single-lever one-hole sink mixer, with high swivel spout, luxury type.



G424C
Miscelatore monocomando per lavello, con bocca girevole, modello corto, tipo lusso.
Single-lever one-hole sink mixer, with swivel spout, luxury type, shorter model.



G424U
Miscelatore monocomando per lavello, con bocca alta a "U" girevole.
Single-lever one-hole sink mixer, with high "U" swivel spout.



G434
Miscelatore monocomando per lavello a muro, con leva frontale e bocca alta girevole.
Single-lever wall mounted sink mixer, with frontal lever and high swivel spout.



G434C
Miscelatore monocomando per lavello a muro, con leva frontale e bocca girevole modello corto.
Single-lever wall mounted sink mixer, with frontal lever and swivel spout, shorter model.

TEN

GIGA FOUR

KISS

REMIX

35

KISS



KISS

OPZIONI MANIGLIA

La collezione è disponibile con diverse varianti di maniglia.
Selezionare la preferenza al momento dell'ordine.

KISS

LEVER OPTIONS

*The collection is available with different lever options.
Select your preference before ordering.*

La serie è dotata di cartuccia a dischi ceramici Ø 40 mm.

The series is equipped with a Ø 40 mm ceramic disc cartridge.



K10

K10



K102



K103



K104

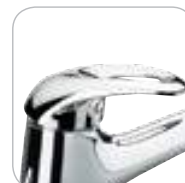

TEN

GIGA FOUR

KISS

REMIX

35

LAVABI - WASHBASIN MIXERS



Miscelatore monocomando lavabo.
Single-lever basin mixer.

K10

con scarico.
with pop-up waste.



K10P

con scarico in plastica.
with plastic pop-up waste.



K11

senza scarico.
without waste.



Miscelatore monocomando per lavabo, con bocca lunga.
Single-lever basin mixer with long spout.

K10L

con scarico.
with pop-up waste.



K10LP

con scarico in plastica.
with plastic pop-up waste.



K11L

senza scarico.
without waste.



K11G

Miscelatore monocomando per lavabo o lavello, con bocca girevole, senza scarico.
Single-lever one-hole basin or sink mixer, with swivel spout, without waste.

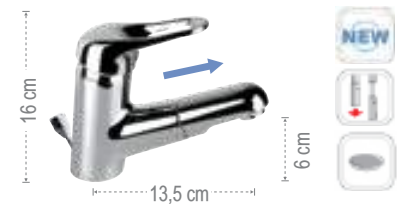

K10E

Miscelatore monocomando lavabo con bocca estraibile con scarico.
Single-lever basin mixer with pull-out spout and pop-up waste.

BIDET - BIDET MIXERS



Miscelatore monocomando per bidet, con aeratore direzionabile.
Single-lever bidet mixer with adjustable aerator.

K20

con scarico.
with pop-up waste.



K20P

con scarico in plastica.
with plastic pop-up waste.



K21

senza scarico.
without waste.



K23

Miscelatore monocomando per bidet, con doccetta, senza scarico.
Single-lever bidet mixer with spray, without waste.



K24

Miscelatore monocomando per bidet, con deviatore e doccetta, senza scarico.
Single-lever bidet mixer with diverter and spray, without waste.

VASCA - BATH MIXERS

TEN

GIGA FOUR

KISS

REMIX

35



Miscelatore monocomando per vasca, esterno.
Single-lever external bath mixer.

K02
con doccetta in ABS anticalcare ad 1 funzione e supporto snodato flessibile 150 cm.
with 1 function antilimestone ABS handshower and swivel shower holder, flexible hose 150 cm.



K05
senza kit doccia.
without shower kit.



Miscelatore monocomando per vasca, su colonnette.
Single-lever external bath mixer on columns.

K08UK
con doccetta in ABS anticalcare ad 1 funzione e supporto snodato flessibile 150 cm.
with 1 function antilimestone ABS handshower and swivel shower holder, flexible hose 150 cm.



K01
senza kit doccia.
without shower kit.



Miscelatore lavabo/vasca con canna fusa lunga e deviatore.
Wall basin/bath single lever mixer with long casted spout with diverter.

K49
con doccetta in ABS anticalcare ad 1 funzione e supporto snodato, flessibile 150 cm.
with 1 function antilimestone ABS handshower and swivel shower holder, flexible hose 150 cm.



K46
senza kit doccia.
without shower kit.



Miscelatore monoforo lavabo/vasca con deviatore integrato.
Single-lever one-hole basin/bath mixer with diverter.

K03
con doccetta in ABS anticalcare ad 1 funzione e supporto snodato, flessibile 150 cm.
with 1 function antilimestone ABS handshower and swivel shower holder, flexible hose 150 cm.



K04
senza kit doccia.
without shower kit.



K07
Miscelatore monocomando bordo vasca con deviatore integrato nel miscelatore, bocca effetto cascata e doccetta estraibile in ABS a 4 funzioni anticalcare.
Single lever deck bath/shower mixer with diverter integrated on the mixer, spout with waterfall jet, antilimestone pull-out ABS handshower 4 functions.



K07UF
Miscelatore monocomando bordo vasca con deviatore integrato nella bocca, e doccetta in ABS estraibile con idromassaggio e anticalcare a 4 funzioni.
Single lever deck bath/shower mixer with diverter integrated on the spout, antilimestone pull-out ABS handshower 4 functions.



DOCCE - SHOWER MIXERS



311311DA
Saliscendi con doccetta anticalcare, con getti in silicone.
Sliding rail set with antilimestone handshower.



Miscelatore monocomando esterno doccia con leva frontale.
Wall mounted single-lever shower mixer with frontal lever.

K38
con doccetta in ABS anticalcare ad 1 funzione e supporto snodato flessibile 150 cm.
with 1 function antilimestone ABS handshower and swivel shower holder, flexible hose 150 cm.



K33
senza kit doccia.
without shower kit.



Miscelatore monocomando esterno doccia.
Wall mounted single-lever shower mixer.

K39
con doccetta in ABS anticalcare ad 1 funzione e supporto snodato flessibile 150 cm.
with 1 function antilimestone ABS handshower and swivel shower holder, flexible hose 150 cm.



K31
senza kit doccia.
without shower kit.

INCASSI DOCCIA - BUILT-IN MIXERS



K30
Miscelatore monocomando incasso doccia.
Built-in single-lever shower mixer.



K09
Miscelatore monocomando incasso vasca/doccia con deviatore.
Built-in single-lever bath/shower mixer with diverter.

CUCINA - KITCHEN MIXERS



K40
Miscelatore monocomando per lavello, con bocca girevole.
Single-lever one-hole sink mixer, with swivel spout.

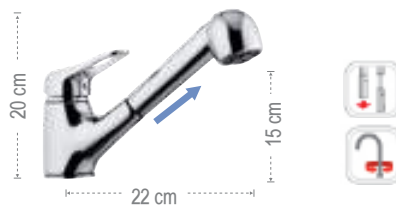

K47
Miscelatore monocomando per lavello, con doccia estraibile a getto variabile.
Single-lever one-hole sink mixer, with pull-out spray jet shower, 2 functions.



K42R
Miscelatore monocomando monoforo 90° per lavello, con bocca alta girevole ed abbattibile, tipo lusso, modello sottofinestra.
Single-lever one-hole sink mixer, with high spout swivel and foldable, luxury type, under window type.



K42
Miscelatore monocomando per lavello, con bocca alta girevole, tipo lusso.
Single-lever one-hole sink mixer, with high swivel spout, luxury type.



K42C
Miscelatore monocomando per lavello, con bocca girevole, modello corto, tipo lusso.
Single-lever one-hole sink mixer, with swivel spout, luxury type, shorter model.



K42U
Miscelatore monocomando per lavello, con bocca alta a "U" girevole.
Single-lever one-hole sink mixer, with high "U" swivel spout.



K43
Miscelatore monocomando per lavello a muro, con leva frontale e bocca alta girevole.
Single-lever wall mounted sink mixer, with frontal lever and high swivel spout.



K43C
Miscelatore monocomando per lavello a muro, con leva frontale e bocca girevole modello corto.
Single-lever wall mounted sink mixer, with frontal lever and swivel spout, shorter model.



K41
Miscelatore monocomando per lavello a muro, con bocca girevole.
Single-lever wall mounted sink mixer, with swivel spout.



K41S
Miscelatore monocomando per lavello a muro, con bocca a "S" girevole.
Single-lever wall mounted sink mixer, with "S" swivel spout.

LINEA PARRUCCHIERE - HAIRDRESSER LINE MIXER



K66
Mixer per acconciatore completo con doccia estraibile.
Barber mixer complete with pull-out shower.

LINEA CLINICA BAGNO - BASIN CLINIC LINE MIXERS

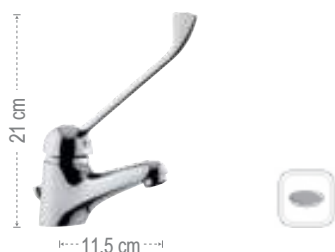

K14
Miscelatore lavabo con scarico e leva lunga.
Wash basin mixer with pop-up waste and long lever.



K14L
Miscelatore lavabo con bocca lunga, scarico e leva lunga.
Wash basin mixer with long spout, pop-up waste and long lever.



K11GLL
Miscelatore monocomando per lavabo o lavello, con bocca girevole e leva lunga, senza scarico.
Single-lever one-hole basin or sink mixer, with swivel spout and long lever, without waste.

TEN

GIGA FOUR

KISS

REMIX

35

LINEA CLINICA DOCCIA - SHOWER CLINIC LINE MIXERS



Miscelatore monocomando esterno doccia con leva lunga.
Wall mounted single-lever shower mixer with long lever.

K39LL

con doccetta in ABS anticalcare ad 1 funzione e supporto snodato flessibile 150 cm.
with 1 function antilimescale ABS handshower and swivel shower holder, flexible hose 150 cm.



K31LL

senza kit doccia.
without shower kit.

LINEA CLINICA CUCINA - KITCHEN CLINIC LINE MIXERS



K44

Miscelatore lavello con bocca girevole e leva lunga.
Sink mixer with swivel spout and long lever.



K42LL

Miscelatore monocomando per lavello, con bocca alta girevole e leva lunga.
Single-lever one-hole sink mixer, with high swivel spout and long lever.

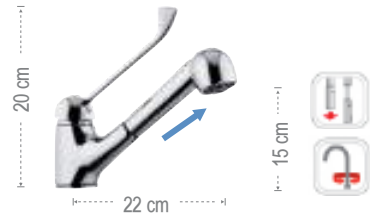

K47LL

Miscelatore monocomando per lavello con leva lunga e doccia estraibile a getto variabile.
Single-lever one-hole sink mixer with long lever and with pull-out spray jet shower with 2 functions.

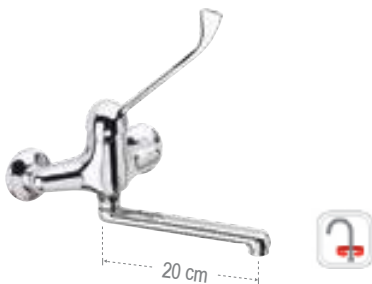

K45

Miscelatore monocomando per lavello a muro con leva lunga e bocca girevole.
Wall mounted single lever sink mixer with swivel spout and long lever.



K45S

Miscelatore monocomando per lavello a muro con leva lunga e bocca a "S" girevole.
Wall mounted single lever sink mixer with swivel "S" spout and long lever.

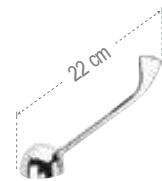

MA14

Leva lunga per miscelatori con cartuccia Ø 40.
Spare long lever for single lever mixers with cartridge Ø 40.

LINEA ACQUA POTABILE - DRINKING WATER LINE MIXERS



K40AP
 Miscelatore monocomando per lavello, con bocca girevole, con selettore per acqua potabile (tre vie di ingresso).
Single-lever one-hole sink mixer, with swivel spout, with selector for drinking water (three ways inlet).



K40DW
 Miscelatore lavello a tre vie di ingresso con bocca girevole, con selezione acqua potabile tramite la leva, con 2 aeratori in uscita.
Three ways inlet single lever sink mixer, with swivel spout, with selection for drinking water directly from the lever, with 2 exit aerators.

LINEA BASSA PRESSIONE - LOW PRESSURE LINE MIXERS



K40BP
 Miscelatore monocomando per lavello, con bocca girevole, per bassa pressione.
Single-lever one-hole sink mixer, with swivel spout, for low pressure.



K40BPC
 Miscelatore monocomando per lavabo o lavello, con bocca girevole corta, per bassa pressione.
Single-lever one-hole basin or sink mixer, with short swivel spout, for low pressure.



K41BP
 Miscelatore monocomando per lavello a muro, con bocca girevole, per bassa pressione.
Single-lever wall mounted sink mixer, with swivel spout, for low pressure.

LINEA MONO ACQUA - SINGLE WATER LINE MIXERS



K11M
 Miscelatore monocomando e monoacqua per lavabo senza scarico.
Single-lever single-water line basin mixer without waste.



K11GM
 Miscelatore monocomando e monoacqua per lavabo o lavello, con bocca girevole, senza scarico.
Single-lever single-water line basin or sink mixer, with swivel spout, without waste.



K42M
 Miscelatore monocomando mono acqua per lavello, con bocca alta girevole.
Single-lever single-water one-hole sink mixer, with high swivel spout.



K42UM
 Miscelatore monocomando monoacqua per lavello, con bocca alta a "U" girevole.
Single-lever single water one-hole sink mixer, with high "U" swivel spout.



K40M
 Miscelatore monocomando mono acqua per lavello, con bocca girevole.
Single-lever single-water one-hole sink mixer, with swivel spout.

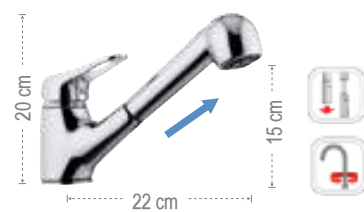

K47M
 Miscelatore monocomando monoacqua per lavello, con doccia estraibile a getto variabile.
Single-lever single water one-hole sink mixer, with pull-out spray jet shower two functions.

TEN

GIGA FOUR

KISS

REMIX

35

REMIX



REMIX

OPZIONI MANIGLIA

La collezione è disponibile con diverse varianti di maniglia. Selezionare la preferenza al momento dell'ordine.

REMIX

LEVER OPTIONS

The collection is available with different lever options. Select your preference before ordering.

La serie è dotata di cartuccia a dischi ceramici Ø 35 mm.

The series is equipped with a Ø 35 mm ceramic disc cartridge.



R10

TEN

GIGA FOUR

KISS

REMIX

35

R10



R102



R103



R104



R106



R107



LAVABI E BIDET - WASHBASIN AND BIDET MIXERS



Miscelatore monocomando lavabo.
Single-lever basin mixer.

R10

con scarico.
with pop-up waste.



R10P

con scarico in plastica.
with plastic pop-up waste.



R11

senza scarico.
without waste.



Miscelatore monocomando per bidet, con aeratore direzionabile.
Single-lever bidet mixer with adjustable aerator.

R20

con scarico.
with pop-up waste.



R20P

con scarico in plastica.
with plastic pop-up waste.



R21

senza scarico.
without waste.



R11G

Miscelatore monocomando per lavabo o lavello, con bocca girevole, senza scarico.
Single-lever one-hole basin or sink mixer, with swivel spout, without waste.

VASCA - BATH MIXERS



Miscelatore monocomando per vasca, esterno.
Single-lever external bath mixer.

R02

con doccetta in ABS anticalcare ad 1 funzione e supporto snodato flessibile 150 cm.
with 1 function antilimestone ABS handshower and swivel shower holder, flexible hose 150 cm.



R05

senza kit doccia.
without shower kit.



Miscelatore lavabo/vasca con canna fusa lunga e deviatore.
Wall basin/bath single lever mixer with long casted spout with diverter.

R49

con doccetta in ABS anticalcare ad 1 funzione e supporto snodato, flessibile 150 cm.
with 1 function antilimestone ABS handshower and swivel shower holder, flexible hose 150 cm.



R46

senza kit doccia.
without shower kit.



R07

Miscelatore monocomando bordo vasca serie Remix con deviatore integrato nella bocca, bocca fusa e doccetta estraibile ad 1 funzione.
Single lever deck bath/shower mixer with diverter integrated on the spout, casted spout, antilimestone pull-out handshower 1 function.





TEN

GIGA FOUR

KISS

REMIX

35

R02

DOCCE - SHOWER MIXERS



Miscelatore monocomando esterno doccia.
Wall mounted single-lever shower mixer.

R39

con doccetta in ABS anticalcare ad 1 funzione e supporto snodato flessibile 150 cm.
with 1 function antilimestone ABS handshower and swivel shower holder, flexible hose 150 cm.



R31

senza kit doccia.
without shower kit.



Miscelatore monocomando esterno doccia con leva frontale.
Wall mounted single-lever shower mixer with frontal lever.

R38

con doccetta in ABS anticalcare ad 1 funzione e supporto snodato flessibile 150 cm.
with 1 function antilimestone ABS handshower and swivel shower holder, flexible hose 150 cm.



R33

senza kit doccia.
without shower kit.



R37

Colonna doccia con deviatore, completa di doccetta anticalcare 4 getti, flessibile 150 cm e soffione 4 getti anticalcare.
Shower column with diverter, complete with handshower antilimestone 4 jets, flexible hose 150 cm and shower head, 4 jets antilimestone.



311311DA

Saliscendi con doccetta anticalcare, con getti in silicone.
Sliding rail set with antilimestone handshower.



INCASSI DOCCIA - BUILT-IN MIXERS



R30

Miscelatore monocomando incasso doccia completo.
Complete built-in single-lever shower mixer.

N30B

Parte interna miscelatore monocomando incasso doccia.
Single-lever shower mixer (built-in components).

R30E

Parte esterna miscelatore monocomando incasso doccia.
Single-lever shower mixer (external components).



R09

Miscelatore monocomando incasso vasca/doccia con deviatore.
Built-in single-lever bath/shower mixer with diverter.

N09B

Parte interna miscelatore monocomando incasso vasca/doccia con deviatore.
Single-lever bath/shower mixer with diverter (built-in components).

R09E

Parte esterna miscelatore monocomando incasso vasca/doccia con deviatore.
Single-lever bath/shower mixer with diverter (external components).

CUCINA - KITCHEN MIXERS



R40
Miscelatore monocomando per lavello, con bocca girevole.
Single-lever one-hole sink mixer, with swivel spout.



R42B
Miscelatore monocomando per lavello, con bocca alta girevole.
Single-lever one-hole sink mixer, with high swivel spout.



R42R
Miscelatore monocomando monoforo 90° per lavello, con bocca alta girevole ed abbattibile, tipo lusso, modello sottofinestra.
Single-lever one-hole sink mixer, with high swivel and foldable spout, luxury type, under window type.



R42
Miscelatore monocomando per lavello, con bocca alta girevole.
Single-lever one-hole sink mixer, with high swivel spout.



R42C
Miscelatore monocomando per lavello, con bocca a "C" girevole, tipo lusso modello corto.
Single-lever one-hole sink mixer, with "C" swivel spout, shorter model, luxury type.



R42U
Miscelatore monocomando per lavello, con bocca alta a "U" girevole.
Single-lever one-hole sink mixer, with high "U" swivel spout.



R41
Miscelatore monocomando per lavello a muro, con bocca girevole.
Single-lever wall mounted sink mixer, with swivel spout.



R41S
Miscelatore monocomando per lavello a muro, con bocca a "S" girevole.
Single-lever wall mounted sink mixer, with "S" swivel spout.



R43
Miscelatore monocomando per lavello a muro, con leva frontale e bocca alta girevole.
Single-lever wall mounted sink mixer, with frontal lever and high swivel spout.



R43C
Miscelatore monocomando per lavello a muro, con leva frontale e bocca a "C" girevole, modello corto.
Single-lever wall mounted sink mixer, with frontal lever with "C" swivel spout, shorter model.

TEN

GIGA FOUR

KISS

REMIX

35

35



35

OPZIONI MANIGLIA

La collezione è disponibile con diverse varianti di maniglia. Selezionare la preferenza al momento dell'ordine.

35

LEVER OPTIONS

The collection is available with different lever options. Select your preference before ordering.

La serie è dotata di cartuccia a dischi ceramici Ø 35 mm.

The series is equipped with a Ø 35 mm ceramic disc cartridge.

TEN

GIGA FOUR

KISS

REMIX

35



F10



F102

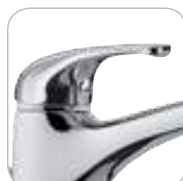

F103

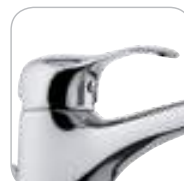

F104

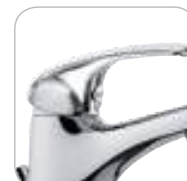

LAVABI E BIDET - WASHBASIN AND BIDET MIXERS



Miscelatore monocomando lavabo.
Single-lever basin mixer.

F102SO

con scarico.
with pop-up waste.



F102

con scarico in plastica.
with plastic pop-up waste.



F112

senza scarico.
without waste.



Miscelatore monocomando per bidet, con aeratore direzionabile.
Single-lever bidet mixer with adjustable aerator.

F202SO

con scarico.
with pop-up waste.



F202

con scarico in plastica.
with plastic pop-up waste.



F212

senza scarico.
without waste.



F112G

Miscelatore monocomando per lavabo o lavello, con bocca girevole.
Single-lever one-hole basin or sink mixer, with swivel spout, without waste.



F232

Miscelatore monocomando per bidet, con doccetta spray.
Single-lever bidet mixer with spray.

VASCA - BATH MIXERS



Miscelatore monocomando per vasca, esterno.
Single-lever external bath mixer.

F022

con doccetta in ABS anticalcare ad 1 funzione e supporto snodato flessibile 150 cm.
with 1 function antilimestone ABS handshower and swivel shower holder, flexible hose 150 cm.



F052

senza kit doccia.
without shower kit.



Miscelatore lavabo/vasca con canna fusa lunga e deviatore.
Wall basin/bath single lever mixer with long casted spout with diverter.

F492

con doccetta in ABS anticalcare ad 1 funzione e supporto snodato, flessibile 150 cm.
with 1 function antilimestone ABS handshower and swivel shower holder, flexible hose 150 cm.



F462

senza kit doccia.
without shower kit.



F072

Miscelatore monocomando bordo vasca serie Remix con deviatore integrato nella bocca, bocca fusa e doccetta estraibile ad 1 funzione.
Single lever deck bath/shower mixer with diverter integrated on the spout, casted spout, antilimestone pull-out handshower 1 function.



91

Bocca incasso miscelatore vasca-doccia.
Built-in spout for bath-shower mixer.



91D

Bocca incasso vasca-doccia, con deviatore integrato.
Built-in spout for bath-shower, with diverter.

DOCCE - SHOWER MIXERS



Miscelatore monocomando esterno doccia.
Wall mounted single-lever shower mixer.

F392

con doccetta in ABS anticalcare ad 1 funzione e supporto snodato flessibile 150 cm.
with 1 function antilimestone ABS handshower and swivel shower holder, flexible hose 150 cm.



F312

senza kit doccia.
without shower kit.



Miscelatore monocomando esterno doccia con leva frontale.
Wall mounted single-lever shower mixer with frontal lever.

F382

con doccetta in ABS anticalcare ad 1 funzione e supporto snodato flessibile 150 cm.
with 1 function antilimestone ABS handshower and swivel shower holder, flexible hose 150 cm.



F332

senza kit doccia.
without shower kit.

INCASSI DOCCIA - BUILT-IN MIXERS



F302

Miscelatore monocomando incasso doccia completo.
Complete built-in single-lever shower mixer.

N30B

Parte interna miscelatore monocomando incasso doccia.
Single-lever shower mixer (built-in components).

F30E

Parte esterna miscelatore monocomando incasso doccia.
Single-lever shower mixer (external components).



F092

Miscelatore monocomando incasso vasca/doccia completo con deviatore.
Complete built-in single-lever bath/shower mixer with diverter.

N09B

Parte interna miscelatore monocomando incasso vasca/doccia con deviatore.
Single-lever bath/shower mixer with diverter (built-in components).

F09E

Parte esterna miscelatore monocomando incasso vasca/doccia con deviatore.
Single-lever bath/shower mixer with diverter (external components).

TEN

GIGA FOUR

KISS

REMIX

35

CUCINA - KITCHEN

**F402**

Miscelatore monocomando per lavello, con bocca girevole.
Single-lever one-hole sink mixer, with swivel spout.+

**F412**

Miscelatore monocomando per lavello a muro, con bocca girevole.
Single-lever wall mounted sink mixer, with swivel spout.

**F412S**

Miscelatore monocomando per lavello a muro, con bocca a "S" girevole.
Single-lever wall mounted sink mixer, with "S" swivel spout.

**F422**

Miscelatore monocomando per lavello, con bocca alta girevole.
Single-lever one-hole sink mixer, with high swivel spout.

**F422C**

Miscelatore monocomando per lavello, con bocca alta girevole, modello corto.
Single-lever one-hole sink mixer, with "C" swivel spout, shorter model.

**F422U**

Miscelatore monocomando per lavello, con bocca alta a "U" girevole.
Single-lever one-hole sink mixer, with high "U" swivel spout.

**F422R**

Miscelatore monocomando monoforo 90° per lavello, con bocca alta girevole ed orientabile, tipo lusso, modello sottofinestra.
Single-lever one-hole sink mixer, with swivel and orientable high spout, luxury type, under window type.

**F432**

Miscelatore monocomando per lavello a muro, con leva frontale e bocca alta girevole.
Single-lever wall mounted sink mixer, with frontal lever and high swivel spout.

**F432C**

Miscelatore monocomando per lavello a muro, con leva frontale e bocca a "C" girevole, modello corto.
Single-lever wall mounted sink mixer, with frontal lever and "C" swivel spout, shorter model.

LINEA MONO ACQUA - SINGLE WATER LINE

**F112GM**

Miscelatore monocomando e mono acqua per lavabo o lavello, con bocca girevole.
Single-lever single-water line basin or sink mixer, with swivel spout.

**F402M**

Miscelatore monocomando mono acqua per lavello, con bocca girevole.
Single-lever single-water one-hole sink mixer, with swivel spout.

**F422UM**

Miscelatore monocomando mono acqua per lavello, con bocca alta a "U" girevole.
Single-lever single water one-hole sink mixer, with high "U" swivel spout.

**F422M**

Miscelatore monocomando mono acqua per lavello, con bocca alta girevole.
Single-lever single-water one-hole sink mixer, with high swivel spout.

**F422CM**

Miscelatore monocomando mono acqua per lavello, con bocca a "C" girevole, tipo lusso, modello corto.
Single-lever single-water one-hole sink mixer, with "C" swivel spout, shorter model, luxury type.

INTERASSE 100mm - INTERAXIS 100mm



Miscelatore lavabo/vasca interasse 100 mm con canna fusa lunga 30 cm e deviatore.
Wall basin/bath single lever mixer interaxis 100 mm with 30 cm long casted spout with diverter.

C492

con doccetta in ABS anticalcare ad 1 funzione e supporto snodato, flessibile 150 cm.
with 1 function antilimestone ABS handshower and swivel shower holder, flexible hose 150 cm.



C462

senza kit doccia.
without shower kit.



Miscelatore monocomando esterno doccia, con interasse 100 mm.
Wall mounted single-lever shower mixer, interaxis 100 mm.

C392

con doccetta in ABS anticalcare ad 1 funzione e supporto snodato flessibile 150 cm, con interasse 100 mm.
with 1 function antilimestone ABS handshower and swivel shower holder, flexible hose 150 cm, interaxis 100 mm.



C312

senza kit doccia.
without shower kit.



Miscelatore monocomando esterno doccia con leva frontale, interasse 100 mm.
Wall mounted single-lever shower mixer with frontal lever, interaxis 100 mm.

C382

con doccetta in ABS anticalcare ad 1 funzione e supporto snodato flessibile 150 cm, con interasse 100 mm.
with 1 function antilimestone ABS handshower and swivel shower holder, flexible hose 150 cm, interaxis 100 mm.



C332

senza kit doccia.
without shower kit.

INTERASSE 100 CUCINA - INTERAXIS 100 KITCHEN



C412

Miscelatore monocomando per lavello a muro, con bocca girevole, interasse 100 mm.
Single-lever wall mounted sink mixer, with swivel spout, interaxis 100 mm.

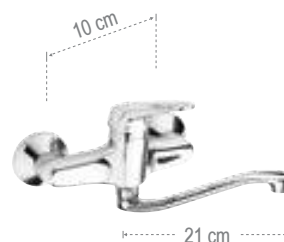

C412S

Miscelatore monocomando per lavello a muro, con bocca a "S" girevole, interasse 100 mm.
Single-lever wall mounted sink mixer, with "S" swivel spout, interaxis 100 mm.



C432

Miscelatore monocomando per lavello a muro, con leva frontale e bocca alta girevole, interasse 100 mm.
Single-lever wall mounted sink mixer, with frontal lever and high swivel spout, interaxis 100 mm.



C432C

Miscelatore monocomando per lavello a muro, con leva frontale e bocca a "C" girevole, modello corto, interasse 100 mm.
Single-lever wall mounted sink mixer, with frontal lever with "C" swivel spout, shorter model, interaxis 100 mm.



DESIGN

DESIGN MINIMALE - MINIMAL DESIGN

CONTRACT

CLASSICA - CLASSIC

TERMOSTATICI - THERMOSTATICS

SENSOR & TEMPOR

ACCESSORI - ACCESSORIES



LIBERTY

pag. 208



1000-2000

pag. 220

LIBERTY

LIBERTY



La serie può essere dotata di vitoni tradizionali oppure di vitoni ceramici.
Selezionare la preferenza al momento dell'ordine.

The series can be equipped with traditional headvalves or ceramic headvalves. Select your preference before ordering.

LIBERTY

1000-2000





DO [▲] oro lucido
shiny gold

LIBERTY

OPZIONI DI FINITURA

Questa collezione di rubinetteria è disponibile con diverse opzioni di finitura, scegli il colore perfetto per il tuo progetto di arredo!

Rispondendo alle esigenze stilistiche dei progetti più ambiziosi, Remer Rubinetterie ha selezionato colori alternativi, oltre al cromato, studiati per arricchire, personalizzare e differenziare gli interni di bagno e cucina.

[Per confermare la propria scelta, aggiungere il codice della finitura al termine del codice prodotto durante la fase di acquisto.]

LIBERTY

FINISHING OPTIONS

This faucet collection is available with different finishing options, choose the perfect color to customize your interior!

Responding to the stylistic needs of the most ambitious designs, Remer Rubinetterie selected alternative colors, in addition to chrome, to enrich, customize and differentiate bathroom and kitchen interiors.

[To confirm your choice, add the finishing code at the end of the item code during the purchase phase.]



VR vecchio rame
old copper

CR



cromo
chrome

CR

FIN 1



vecchio ottone
old brass

VO



vecchio rame
old copper

VR

FIN 2



oro lucido
shiny gold

DO

LIBERTY

VITONE CERAMICO - CERAMIC HEAD VALVE



Disponibile anche con vitone ceramico;
aggiungere "CE" alla fine del codice.
*Available also with ceramic head valve;
add "CE" at the end of the article number.*

SOLO MANIGLIA - ONLY LEVER



71LI
Maniglia.
Lever.



LAVABI - WASHBASINS MIXERS



Batteria lavabo/lavello da incasso senza scarico.
Concealed 2-handle basin/sink faucet without waste.

ART.	10LI	10LICE
FINITURA FINISHING	VITONE TRADIZIONALE TRADITIONAL HEAD VALVE	VITONE CERAMICO CERAMIC HEAD VALVE



Batteria lavabo con scarico automatico.
2-handle basin faucet set with pop-up waste.

ART.	11LI	11LICE
FINITURA FINISHING	VITONE TRADIZIONALE TRADITIONAL HEAD VALVE	VITONE CERAMICO CERAMIC HEAD VALVE



Batteria lavabo con bocca a "C" e scarico automatico.
Altezza bocca 9,5 cm, interasse 19 cm.
2-handle basin faucet set with "C" spout and pop-up waste. Height spout 9,5 cm, Interaxis 19 cm.

ART.	11CLI	11CLICE
FINITURA FINISHING	VITONE TRADIZIONALE TRADITIONAL HEAD VALVE	VITONE CERAMICO CERAMIC HEAD VALVE

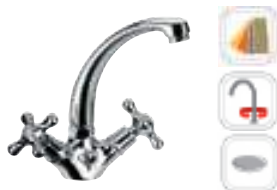

Miscelatore tradizionale bicomando monoforo per lavabo, con canna fusa e scarico automatico.
Altezza 20 cm, interasse 17 cm.
One-hole traditional 2-handle basin faucet, with casted spout and pop-up waste. Height 20 cm, Interaxis 17 cm.

ART.	13CLI	13CLICE
FINITURA FINISHING	VITONE TRADIZIONALE TRADITIONAL HEAD VALVE	VITONE CERAMICO CERAMIC HEAD VALVE



Miscelatore tradizionale bicomando monoforo per lavabo, con canna alta e scarico automatico.
Altezza 26 cm, interasse 19 cm.
One-hole traditional 2-handle basin faucet, with high spout and pop-up waste. Height 26 cm, Interaxis 19 cm.

ART.	13GLI	13GLICE
FINITURA FINISHING	VITONE TRADIZIONALE TRADITIONAL HEAD VALVE	VITONE CERAMICO CERAMIC HEAD VALVE



Miscelatore tradizionale bicomando monoforo lavabo con scarico click-clack con troppopieno.
Altezza 17,5 cm, interasse 13 cm.
One-hole 2-handle basin faucet with click-clack waste with overflow. Height 17,5 cm, Interaxis 13 cm.

ART.	13LIB	13LIBCE
FINITURA FINISHING	VITONE TRADIZIONALE TRADITIONAL HEAD VALVE	VITONE CERAMICO CERAMIC HEAD VALVE



Miscelatore tradizionale bicomando monoforo lavabo con scarico automatico.
Altezza bocca 7 cm, interasse 13 cm.
One-hole 2-handle basin faucet with pop-up waste. Height spout 7 cm, Interaxis 13 cm.

ART.	13LI	13LICE
FINITURA FINISHING	VITONE TRADIZIONALE TRADITIONAL HEAD VALVE	VITONE CERAMICO CERAMIC HEAD VALVE



Monocomando lavabo con scarico.
Single-lever basin mixer with pop-up waste.

ART.	LA10
FINITURA FINISHING	VITONE TRADIZIONALE TRADITIONAL HEAD VALVE



Monocomando lavabo con scarico.
Single-lever basin mixer with pop-up waste.

ART.	LV10
FINITURA FINISHING	VITONE TRADIZIONALE TRADITIONAL HEAD VALVE



Miscelatore tradizionale bicomando monoforo per lavabo, con canna antica e scarico automatico. Altezza 23,5 cm, interasse 23 cm.
One-hole traditional 2-handle basin faucet, with "Antique" spout and pop-up waste. Height 23,5 cm, Interaxis 23 cm.

ART.	13ALI	13ALICE
FINITURA FINISHING	VITONE TRADIZIONALE TRADITIONAL HEAD VALVE	VITONE CERAMICO CERAMIC HEAD VALVE



Miscelatore tradizionale bicomando monoforo per lavabo, con canna tubo e scarico automatico. Altezza 29 cm, interasse 19 cm.
One-hole traditional 2-handle basin faucet, with tube spout and pop-up waste. Height 29 cm, Interaxis 19 cm.

ART.	13ULI	13ULICE
FINITURA FINISHING	VITONE TRADIZIONALE TRADITIONAL HEAD VALVE	VITONE CERAMICO CERAMIC HEAD VALVE



Gruppo lavabo tipo a ponte, canna Ø18 cm senza scarico. Altezza 28/28 cm, interasse 14,5 cm.
2-handle basin faucet bridge type, spout Ø18 cm without waste. Height 27/28 cm, Interaxis 14,5 cm.

ART.	14LI	14LICE
FINITURA FINISHING	VITONE TRADIZIONALE TRADITIONAL HEAD VALVE	VITONE CERAMICO CERAMIC HEAD VALVE

BIDET - BIDET MIXERS



Batteria bidet con scarico automatico.
2-handle bidet faucet set with pop-up waste.

ART.	21LI	21LICE
FINITURA FINISHING	VITONE TRADIZIONALE TRADITIONAL HEAD VALVE	VITONE CERAMICO CERAMIC HEAD VALVE



Batteria bidet con doccia e scarico automatico.
2-handle bidet faucet with spray and pop-up waste.

ART.	22LI	22LICE
FINITURA FINISHING	VITONE TRADIZIONALE TRADITIONAL HEAD VALVE	VITONE CERAMICO CERAMIC HEAD VALVE

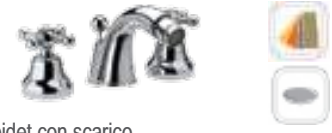

Batteria bidet con scarico.
2-handle bidet faucet with pop-up waste. Height 10,9 cm, Interaxis 11,5 cm.

ART.	20LI	20LICE
FINITURA FINISHING	VITONE TRADIZIONALE TRADITIONAL HEAD VALVE	VITONE CERAMICO CERAMIC HEAD VALVE



Miscelatore tradizionale bicomando monoforo bidet con scarico automatico.
One hole, 2-handle bidet faucet set with pop-up waste.

ART.	23LI	23LICE
FINITURA FINISHING	VITONE TRADIZIONALE TRADITIONAL HEAD VALVE	VITONE CERAMICO CERAMIC HEAD VALVE



Monocomando bidet con scarico.
Single-lever bidet mixer with pop-up waste.

ART.	LA20
FINITURA FINISHING	VITONE TRADIZIONALE TRADITIONAL HEAD VALVE



Monocomando bidet con scarico.
Single-lever bidet mixer with pop-up waste.

ART.	LV20
FINITURA FINISHING	VITONE TRADIZIONALE TRADITIONAL HEAD VALVE

VASCA - BATH MIXERS



Gruppo vasca con doccia duplex e doccetta in ottone ad 1 funzione e flessibile 150 cm.
2-handle bathtub faucet with duplex shower and 1 function brass handshower, flexible hose 150 cm.

ART.	02LI	02LICE
FINITURA FINISHING	VITONE TRADIZIONALE TRADITIONAL HEAD VALVE	VITONE CERAMICO CERAMIC HEAD VALVE



Gruppo vasca esterno su colonnette alte, con doccetta in ottone ad 1 funzione.
Traditional 2-handle bathtub faucet, on high columns, with 1 function brass handshower.

ART.	02LIUK	02LICEUK
FINITURA FINISHING	VITONE TRADIZIONALE TRADITIONAL HEAD VALVE	VITONE CERAMICO CERAMIC HEAD VALVE



Gruppo vasca senza kit doccia.
2-handle bathtub faucet without shower kit.

ART.	05LI	05LICE
FINITURA FINISHING	VITONE TRADIZIONALE TRADITIONAL HEAD VALVE	VITONE CERAMICO CERAMIC HEAD VALVE



Bordo vasca con doccetta in ottone ad 1 funzione estraibile e flessibile 150 cm.
Traditional 2-handle deck bathtub faucet with pull-out 1 function brass handshower and flexible hose 150 cm.

ART.	06LI	06LICE
FINITURA FINISHING	VITONE TRADIZIONALE TRADITIONAL HEAD VALVE	VITONE CERAMICO CERAMIC HEAD VALVE



Batteria vasca incasso con bocca, deviatore, doccetta in ottone ad 1 funzione con supporto snodato e flessibile 150 cm.
Built-in 2-handle bathtub faucet set with spout, diverter, 1 function brass handshower and swivel shower holder, flexible hose 150 cm.

ART.	03LIS01	03LICES01
FINITURA FINISHING	VITONE TRADIZIONALE TRADITIONAL HEAD VALVE	VITONE CERAMICO CERAMIC HEAD VALVE



Batteria vasca incasso con soffione e braccio da 30 cm tutto in ottone, deviatore, doccetta in ottone ad 1 funzione con supporto snodato e flessibile 150 cm.
Built-in 2-handle bathtub faucet set with shower head, shower arm 30 cm, diverter, 1 function brass handshower and swivel shower holder, flexible hose 150 cm. All in brass.

ART.	03LIS02	03LICES02
FINITURA FINISHING	VITONE TRADIZIONALE TRADITIONAL HEAD VALVE	VITONE CERAMICO CERAMIC HEAD VALVE



Gruppo vasca esterno con doccia ad 1 funzione e canna lunga girevole 40 cm.
2-handle bathtub faucet set with 1 function shower and long swivel spout, length 40 cm.

ART.	04LI	04LICE
FINITURA FINISHING	VITONE TRADIZIONALE TRADITIONAL HEAD VALVE	VITONE CERAMICO CERAMIC HEAD VALVE



Gruppo vasca esterno su colonne da pavimento, con doccia.
Altezza bocca 60 cm, interasse 15/20 cm.
Traditional 2-handle bathtub faucet, on freestanding columns, with shower.
Height spout 60 cm, Interaxis 15/20 cm.

ART.	01LI	01LICE
FINITURA FINISHING	VITONE TRADIZIONALE TRADITIONAL HEAD VALVE	VITONE CERAMICO CERAMIC HEAD VALVE



8801LI
Colonne da pavimento, altezza 70 cm.
Floor freestanding columns, height 70 cm.



8801LIS
Coppia colonne vasca in ottone, con supporto doccia, 3/4M x 3/4M., altezza 80 cm.
Couple of brass vertical connections for bath faucet, with handshower holder 3/4M x 3/4M, height 80 cm.



Gruppo vasca con deviatore e attacco 3/4M.
2-handle bathtub faucet with diverter and 3/4M connection.

ART.	07LI	07LICE
FINITURA FINISHING	VITONE TRADIZIONALE TRADITIONAL HEAD VALVE	VITONE CERAMICO CERAMIC HEAD VALVE



Gruppo vasca-doccia tradizionale, con colonna saliscendi, con deviatore, doccetta, flessibile e soffione doccia. Tutto in ottone.
Traditional 2-handle shower/bathtub faucet with sliding rail column with diverter and handshower, with shower hose and shower head. All in chrome plated brass.

ART.	09LIB20	09LICEB20
FINITURA FINISHING	VITONE TRADIZIONALE TRADITIONAL HEAD VALVE	VITONE CERAMICO CERAMIC HEAD VALVE



Gruppo vasca/doccia con colonna doccia lusso e soffione doccia in ottone.
2-handle shower/bathtub faucet with deluxe pipe and shower head.

ART.	08LIB20	08LICEB20
FINITURA FINISHING	VITONE TRADIZIONALE TRADITIONAL HEAD VALVE	VITONE CERAMICO CERAMIC HEAD VALVE

DOCCE - SHOWER MIXERS



Gruppo doccia con colonna saliscendi e deviatore, completa di doccetta con flessibile e soffione a campanella, tutto in ottone.

Wall mounted 2-handle shower faucet with deluxe sliding rail column and diverter, complete with handshower, flexible hose and shower head bell shaped, all in brass.

ART. **37LIRB20** **37LICERB20**

FINITURA FINISHING	VITONE TRADIZIONALE TRADITIONAL HEAD VALVE	VITONE CERAMICO CERAMIC HEAD VALVE
--------------------	--	------------------------------------



Gruppo doccia con colonna lusso e soffione doccia a campanella, tutto in ottone.

Wall mounted 2-handle shower faucet with deluxe pipe and brass shower rose bell shaped.

ART. **36LIRB20** **36LICERB20**

FINITURA FINISHING	VITONE TRADIZIONALE TRADITIONAL HEAD VALVE	VITONE CERAMICO CERAMIC HEAD VALVE
--------------------	--	------------------------------------



317L323CR

Saliscendi lusso, con asta tonda e doccetta, tutto in ottone.

Luxury sliding rail set, with round rod and handshower, all in brass.



Gruppo doccia a muro con attacco superiore 3/4" M. Wall mounted 2-handle shower faucet with upper connection 3/4" M connection.

ART. **35LI** **35LICE**

FINITURA FINISHING	VITONE TRADIZIONALE TRADITIONAL HEAD VALVE	VITONE CERAMICO CERAMIC HEAD VALVE
--------------------	--	------------------------------------



Gruppo doccia a muro, senza kit doccia. Wall mounted 2-handle shower faucet without shower kit.

ART. **38LI** **38LICE**

FINITURA FINISHING	VITONE TRADIZIONALE TRADITIONAL HEAD VALVE	VITONE CERAMICO CERAMIC HEAD VALVE
--------------------	--	------------------------------------



Gruppo doccia a muro con doccia duplex.

Wall mounted 2-handle shower faucet with duplex shower.

ART. **39LI** **39LICE**

FINITURA FINISHING	VITONE TRADIZIONALE TRADITIONAL HEAD VALVE	VITONE CERAMICO CERAMIC HEAD VALVE
--------------------	--	------------------------------------



LV30

Miscelatore monocomando da incasso senza deviatore. Built-in single-lever mixer without diverter.



LV09

Miscelatore monocomando da incasso con deviatore per vasca/doccia. Built-in bath/shower single-lever mixer with diverter.



LA30

Miscelatore monocomando da incasso senza deviatore. Built-in single-lever mixer without diverter.



LA09

Miscelatore monocomando da incasso con deviatore per vasca/doccia. Built-in bath/shower single-lever mixer with diverter.



317L323CR

CUCINA - KITCHEN MIXERS



Gruppo lavello a muro con canna inferiore, lunghezza canna 18 cm.
Sink mixer wall mounted tap, with swivel spout, length spout 18 cm.

ART. 41LI 41LICE

FINITURA FINISHING	VITONE TRADIZIONALE TRADITIONAL HEAD VALVE	VITONE CERAMICO CERAMIC HEAD VALVE
--------------------	--	------------------------------------



Gruppo lavello a muro con canna superiore, lunghezza canna 17,5 cm.
Sink mixer wall mounted, with swivel high spout, length spout 17,5 cm.

ART. 41SLI 41SLICE

FINITURA FINISHING	VITONE TRADIZIONALE TRADITIONAL HEAD VALVE	VITONE CERAMICO CERAMIC HEAD VALVE
--------------------	--	------------------------------------



Gruppo lavello a muro con canna superiore Jota. Altezza 25 cm, interasse 17 cm.
Sink mixer wall mounted, with swivel high J spout. Height 25 cm, Interaxis 17 cm.

ART. 41LIJ 41LIJCE

FINITURA FINISHING	VITONE TRADIZIONALE TRADITIONAL HEAD VALVE	VITONE CERAMICO CERAMIC HEAD VALVE
--------------------	--	------------------------------------



Gruppo lavello bicomando monoforo con canna girevole. Altezza 25 cm, interasse 22,5 cm.
One-hole dual control sink mixer with swivel spout. Height 25 cm, Interaxis 22,5 cm.

ART. 43LI 43LICE

FINITURA FINISHING	VITONE TRADIZIONALE TRADITIONAL HEAD VALVE	VITONE CERAMICO CERAMIC HEAD VALVE
--------------------	--	------------------------------------



Miscelatore tradizionale bicomando per lavello con canna antica. Altezza 23,5 cm, interasse 23 cm.
One-hole dual control sink mixer with antique spout. Height 23,5 cm, Interaxis 23 cm.

ART. 43LIA 43LIACE

FINITURA FINISHING	VITONE TRADIZIONALE TRADITIONAL HEAD VALVE	VITONE CERAMICO CERAMIC HEAD VALVE
--------------------	--	------------------------------------



Gruppo lavello monoforo bicomando con canna Jota. Altezza 27 cm, interasse 18 cm.
One-hole sink mixer dual control with swivel J spout. Height 27 cm, Interaxis 18 cm.

ART. 43LIJ 43LIJCE

FINITURA FINISHING	VITONE TRADIZIONALE TRADITIONAL HEAD VALVE	VITONE CERAMICO CERAMIC HEAD VALVE
--------------------	--	------------------------------------



Gruppo lavello a muro bicomando con canna superiore antica. Altezza 22 cm, interasse 23 cm.
Dual control sink mixer, wall mounted, with swivel high antique spout. Height 22 cm, Interaxis 23 cm.

ART. 41LIA 41LIACE

FINITURA FINISHING	VITONE TRADIZIONALE TRADITIONAL HEAD VALVE	VITONE CERAMICO CERAMIC HEAD VALVE
--------------------	--	------------------------------------



43LIA

LINEA MONO ACQUA - SINGLE WATER LINE



Rubinetto collo cigno 1/2, 3/4.
Wash basin pillar tap, 1/2, 3/4.



1/2		
ART.	15LI	15LICE
FINITURA FINISHING	VITONE TRADIZIONALE TRADITIONAL HEAD VALVE	VITONE CERAMICO CERAMIC HEAD VALVE



Rubinetto incasso dritto 1/2, 3/4.
Built-in straight stop cock, 1/2, 3/4.



3/4		
ART.	31LI	31LICE
FINITURA FINISHING	VITONE TRADIZIONALE TRADITIONAL HEAD VALVE	VITONE CERAMICO CERAMIC HEAD VALVE



Rubinetto con portagomma 1/2.
Wall mounted hose-holder tap, 1/2.



1/2		
ART.	52LI	52LICE
FINITURA FINISHING	VITONE TRADIZIONALE TRADITIONAL HEAD VALVE	VITONE CERAMICO CERAMIC HEAD VALVE



Rubinetto prolungato 1/2.
Wall mounted long tap, 1/2.



3/4		
ART.	15LI34	15LI34CE
FINITURA FINISHING	VITONE TRADIZIONALE TRADITIONAL HEAD VALVE	VITONE CERAMICO CERAMIC HEAD VALVE



Rubinetto a snodo pesante, 1/2" con canna alta a "S" Ø 18 girevole, con rompigetto.
Sink tap 1/2" with high "S" swivel spout Ø 18, and aerator.



1/2		
ART.	53SLI	53SLICE
FINITURA FINISHING	VITONE TRADIZIONALE TRADITIONAL HEAD VALVE	VITONE CERAMICO CERAMIC HEAD VALVE



Rubinetto a squadra per lavatrice, 1/2" x 3/4".
Angle tap for washing machine 1/2" x 3/4".



1/2 x 3/4		
ART.	55LI	55LICE
FINITURA FINISHING	VITONE TRADIZIONALE TRADITIONAL HEAD VALVE	VITONE CERAMICO CERAMIC HEAD VALVE



Rubinetto a snodo pesante, 1/2" canna alta "J", Ø 18, con canna girevole e rompigetto.
Sink tap 1/2", with high "J" swivel spout Ø 18 and aerator.



1/2		
ART.	53JLI	53JLICE
FINITURA FINISHING	VITONE TRADIZIONALE TRADITIONAL HEAD VALVE	VITONE CERAMICO CERAMIC HEAD VALVE



Rubinetto monoforo per lavello con canna alta a "J" e rompigetto.
One-hole sink tap, with high "J" swivel spout and aerator.



1/2		
ART.	54LI	54LICE
FINITURA FINISHING	VITONE TRADIZIONALE TRADITIONAL HEAD VALVE	VITONE CERAMICO CERAMIC HEAD VALVE



Rubinetto a snodo pesante, 1/2" canna Ø 18, con rompigetto.
Sink tap, with swivel spout Ø 18, 1/2 and aerator.



1/2		
ART.	53LI	53LICE
FINITURA FINISHING	VITONE TRADIZIONALE TRADITIONAL HEAD VALVE	VITONE CERAMICO CERAMIC HEAD VALVE



Rubinetto curvo con maniglia MINI Y, 1/2".
Elbow tap with MINI Y handle, 1/2".



1/2		
ART.	57LI	57LICE
FINITURA FINISHING	VITONE TRADIZIONALE TRADITIONAL HEAD VALVE	VITONE CERAMICO CERAMIC HEAD VALVE



Rubinetto curvo con uscita da 1/2" e uscita da bocca di erogazione, attacco 1/2" M.
Angle tap with 1/2" output and spout output, 1/2" M connection.



1/2		
ART.	251LI	251LICE
FINITURA FINISHING	VITONE TRADIZIONALE TRADITIONAL HEAD VALVE	VITONE CERAMICO CERAMIC HEAD VALVE



Rubinetto a snodo con attacco lavatrice e attacco da 1/2" con canna ad S girevole.
Washing machine bibcock, with swivel spout 1/2".



1/2		
ART.	252LI	252LICE
FINITURA FINISHING	VITONE TRADIZIONALE TRADITIONAL HEAD VALVE	VITONE CERAMICO CERAMIC HEAD VALVE

1000-2000



1000 - 2000

OPZIONI MANIGLIA

La collezione è disponibile con diverse varianti di maniglia. Selezionare la preferenza al momento dell'ordine.

1000 - 2000

LEVER OPTIONS

The collection is available with different lever options. Select your preference before ordering.

La collezione è disponibile con diverse varianti di maniglia. Selezionare la preferenza al momento dell'ordine. La serie è dotata di vitoni tradizionali.

The collection is available with different handle options. Select your preference before ordering. The series is equipped with traditional headvalves.

LIBERTY

1000-2000



01EX

Y



YG



EX



G



EG



CA

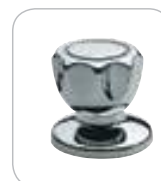

VI



LAVABI - WASHBASIN MIXERS

**11EX**

Batteria lavabo con scarico.
Altezza bocca 6 cm, interasse 10 cm.
Wash basin mixer with pop-up waste.
Height spout 6 cm, Interaxis 10 cm.

**12EX**

Batteria lavabo senza scarico.
Altezza bocca 6 cm, interasse 10 cm.
Wash basin mixer without pop-up waste.
Height spout 6 cm, Interaxis 10 cm.

**13EX**

Monoforo lavabo con scarico.
Altezza 12 cm, interasse 10 cm.
One-hole wash basin mixer with pop-up waste.
Height 12 cm, Interaxis 10 cm.

**14EX**

Gruppo lavabo tipo a ponte, canna Ø18 mm
senza scarico.
Altezza 27 cm, interasse 22 cm.
Wash basin mixer bridge type, spout Ø18 mm
without waste.
Height 27 cm, Interaxis 22 cm.

**14CEX**

Gruppo lavabo tipo a ponte, canna alta a "C"
senza scarico.
Altezza 27 cm, interasse 22 cm.
Wash basin mixer bridge type, high "C" spout
without waste.
Height 27 cm, Interaxis 22 cm.

**17EX**

Gruppo lavabo con interasse 160 mm e canna a
jota Ø18 mm senza scarico.
Altezza 27-28 cm, interasse 14,5 cm.
Wash basin mixer deck-mounted interaxis 160
mm. with jota spout Ø18 mm without waste.
Height 27-28 cm, Interaxis 14,5 cm.

**15EX**

Rubinetto collo cigno 1/2.
Altezza bocca 6 cm, interasse 11 cm.
Wash basin pillar tap, 1/2.
Height spout 6 cm, Interaxis 11 cm.

BIDET - BIDET MIXERS



21EX
 Combinazione bidet con scarico automatico.
Bidet mixer with pop-up waste.



22EX
 Batteria bidet con doccia e scarico.
Bidet mixer with spray and pop-up waste.



23EX
 Monoforo bidet con scarico.
 Altezza bocca 8 cm, interasse 12 cm.
One-hole bidet mixer with pop-up waste 1" 1/4.
 Height spout 8 cm, Interaxis 12 cm.



32EX
 Rubinetto incasso a sfera removibile con maniglia,
 1/2, 3/4.
*Built-in stop cock with reswivel ball valve, with
 handle, 1/2, 3/4.*



25EX
 Rubinetto bidet 1/2.
Bidet tap 1/2.



31EX
 Rubinetto incasso diritto 1/2.
Built-in stop cock, 1/2.



Rubinetto incasso con cappuccio a 2 pezzi, 1/2, 3/4.
*Built-in stop cock with chromed cap in 2 pieces,
 1/2, 3/4.*



Rubinetto incasso a sfera con cappuccio a 2
 pezzi, 1/2, 3/4.
*Built-in ball valve with chromed cap in 2 pieces,
 1/2, 3/4.*



Rubinetto incasso a sfera con maniglia a leva, 1/2,
 3/4.
Built-in ball valve with lever handle, 1/2, 3/4.

VASCA - BATH MIXERS

**01EX**

Gruppo vasca esterno con doccetta in ABS ad 1 funzione e flessibile 150 cm.
Bathtub mixer with ABS 1 function handshower and flexible hose 150 cm.

**02EX**

Gruppo vasca esterno con kit doccia duplex, doccetta in ABS ad 1 funzione, supporto snodato e flessibile 150 cm.
Bathtub mixer with duplex shower kit, with ABS 1 function handshower swivel shower holder and flexible hose 150 cm.

**05EX**

Gruppo vasca esterno senza kit doccia.
Bathtub mixer without shower kit.



Gruppo vasca esterno con forcella singola.
Bathtub mixer, with single fork.

01S

con doccetta in ABS ad 1 funzione e flessibile 150 cm.
with ABS 1 function handshower and flexible hose 150 cm.

**02S**

Gruppo vasca esterno con doccia duplex, doccetta in ABS ad 1 funzione, supporto snodato e flessibile 150 cm forcella singola.
Bathtub mixer with duplex shower, with ABS 1 function handshower swivel shower holder and flexible hose 150 cm, with single fork.

05S

senza kit doccia.
without shower kit.

07EX

Gruppo vasca con deviatore e attacco superiore 3/4 M.
Bathtub mixer with diverter and 3/4 M upper connection.

**08EX**

Gruppo vasca con colonna doccia 1/2x3/4 e soffione doccia standard.
Bathtub mixer with stand pipe 1/2x3/4 and standard shower rose.



04EX

Gruppo vasca esterno con doccia duplex, doppia forcella, doccetta in ABS ad 1 funzione, supporto snodato e flessibile 150 cm; canna lunga girevole 40 cm.
Bathtub mixer with duplex shower with double fork and long swivel spout length 40 cm.



04S

Gruppo vasca esterno con doccia duplex, doccetta in ABS ad 1 funzione, supporto snodato e flessibile 150 cm, canna lunga girevole 40 cm e forcella singola.
Bathtub mixer with duplex shower, with ABS 1 function handshower swivel shower holder and flexible hose 150 cm, long swivel spout length 40 cm, with single fork.

DOCCIA - SHOWER MIXERS



38EX329351EX

Miscelatore esterno doccia con attacco alto e colonna doccia 1/2x3/4 con soffione doccia standard.
Wall mounted shower mixer with higher connection with stand pipe 1/2x3/4 with standard shower head.



55EX329351EX

Colonna doccia 1/2x3/4 con soffione doccia standard e rubinetto a squadra.
Stand pipe 1/2x3/4 with standard shower head and angle tap.



39EX

Gruppo esterno per doccia, doccetta in ABS ad 1 funzione, supporto snodato e flessibile 150 cm.
Wall mounted shower mixer, with ABS 1 function handshower swivel shower holder and flexible hose 150 cm.

38EX

Gruppo esterno per doccia. senza kit doccia.
Wall mounted shower mixer without shower kit.

329EX351EX

Colonna doccia 1/2x3/4 e soffione doccia standard.
Stand pipe 1/2x3/4 and standard shower rose.

CUCINA - KITCHEN

**41EX**

Gruppo lavello con canna inferiore girevole a "S", lunghezza canna 18 cm.
Sink mixer wall mounted, with low "S" swivel spout, length 18 cm.

**41SEX**

Gruppo lavello con canna superiore, unghetta canna 17,5 cm.
Sink mixer wall mounted, with upper swivel spout length 17,5 cm.

**41JEX**

Gruppo lavello con canna alta girevole. Altezza 25 cm, interasse 17 cm.
Sink mixer wall mounted, with high swivel spout. Height 25 cm, Interaxis 17 cm.

**41L**

Gruppo lavello a muro con canna inferiore, interasse 20 cm, lunghezza canna 18 cm.
Sink mixer wall mounted, with low "S" swivel spout length 18 cm, interaxis 200 mm.

**41LS**

Gruppo lavello a muro con canna alta, interasse 20 cm, lunghezza canna 18 cm.
Sink mixer wall mounted, with high swivel spout length 18 cm, interaxis 200 mm.

**42EX**

Gruppo lavello con attacco lavatrice, con canna inferiore lunga 18 cm.
Sink mixer with washing machine connection with low swivel spout length 18 cm.

**43EX**

Monoforo lavello con canna girevole. Altezza 26 cm, interasse 18 cm.
One-hole sink mixer with swivel spout. Height 26 cm, Interaxis 18 cm.

**43CEX**

Monoforo lavello con canna girevole, modello tipo corto. Altezza 21 cm, interasse 12 cm.
One-hole sink mixer with swivel spout, shorter model. Height 21 cm, Interaxis 12 cm.

**45EX**

Monoforo lavello con canna girevole. Altezza 23,5 cm, interasse 20,5 cm.
One-hole sink mixer with swivel spout. Height 23,5 cm, Interaxis 20,5 cm.

**46EX**

Monoforo lavello con deviatore lavastoviglie. Altezza 28 cm, interasse 18 cm.
One-hole sink mixer with dish washer diverter and spout. Height 28 cm, Interaxis 18 cm.

**47EX**

Monoforo lavello con doccia estraibile. Altezza 17 cm, interasse 16 cm.
One-hole sink mixer with pull-out spray jet shower. Height 17 cm, Interaxis 16 cm.

**48EX**

Gruppo miscelatore per boiler con canna girevole e due cannucce in rame cromato, 1/2. Lunghezza canna 15,5 cm, interasse 15 cm.
Mixer for water heater with swiveling spout and two c.p. copper pipes, 1/2. Length spout 15,5 cm, interaxis 15 cm.

LINEA MONO ACQUA - SINGLE WATER LINE

LIBERTY

1000-2000



51EX
Rubinetto prolungato, 1/2.
Wall mounted long tap, 1/2.



52EX
Rubinetto con portagomma, 1/2.
Wall mounted hose-holder tap, 1/2.



53EX
Rubinetto a snodo pesante, 1/2 canna Ø 18 mm lunghezza 21 cm.
Sink tap, with swivel spout Ø 18 lenght 18 cm, 1/2.



53SEX
Rubinetto a snodo pesante, 1/2 con canna alta Ø18 girevole lunga 21 cm, con rompigetto.
Sink tap 1/2, with high swivel spout Ø18, and aerator.



53JEX
Rubinetto a snodo pesante, 1/2 con canna alta a "J" Ø 18 girevole, con rompigetto.
Sink tap 1/2, with high "J" swivel spout Ø18, and aerator.



54EX
Rubinetto monoforo per lavello con canna alta a "J" e rompigetto.
One-hole sink tap, with high "J" swivel spout and aerator.



55EX
Rubinetto a squadra per lavatrice, 1/2x3/4.
Angle tap for washing machine 1/2x3/4.



57EX
Rubinetto curvo con maniglia MINI Y.
Elbow tap with MINI Y handle, 1/2



58EX
Rubinetto curvo con portagomma maniglia MINI Y, 1/2.
Elbow tap, with hose connection, with MINI Y handle, 1/2".



250EX
Rubinetto a due maniglie per attacco lavatrice, 1/2" x 3/4".
Brass washing machine bibcock, heavy model, 1/2" x 3/4".



2501234EX
Rubinetto a due maniglie per attacco lavatrice, 1/2" x 3/4" x 3/4".
Brass washing machine bibcock, heavy model, 1/2" x 3/4" x 3/4".



252EX
Rubinetto a snodo con attacco lavatrice e bocca girevole lunga 17,5 cm, 1/2".
Brass washing machine bibcock, with swivel spout lenght 17,5 cm, 1/2".



251EX
Rubinetto curvo con uscita da 1/2" e uscita da bocca di erogazione, attacco 1/2" M.
Angle tap with 1/2" output and spout output, 1/2" M connection.

Y

EX

CA

MO



71 Y



71 G



71 EX



71 G



71 CA



71 VI



71 EG

Per ordinare solo la maniglia mettere il codice 71 + il codice della maniglia (es. 71 EG)
To order only the handler insert code 71 +code of the handler (ex. 71 EG)

DESIGN

DESIGN MINIMALE - MINIMAL DESIGN

CONTRACT

CLASSICA - CLASSIC

TERMOSTATICI - THERMOSTATICS

SENSOR & TEMPOR

ACCESSORI - ACCESSORIES



ELEGANCE

pag. 232



Q-ELEGANCE

pag. 244

TERMOSTATICI

Un comfort moderno dedicato agli ambienti vasca e doccia. La rubinetteria termostatica permette di selezionare in anticipo la temperatura dell'acqua e di mantenerla costante durante tutto il tempo di utilizzo.

Acqua calda e acqua fredda vengono miscelate alla temperatura desiderata già all'interno della cartuccia termostatica. In questo modo è possibile godersi una doccia rilassante, evitando sia le scottature che gli sbalzi termici dati dall'apertura improvvisa di altri rubinetti.

L'utilizzo dei miscelatori termostatici permette inoltre di avere un maggiore controllo sul consumo di acqua e energia, risparmiando la quantità di acqua e calore solitamente sprecati cercando la temperatura giusta.

La collezioni di miscelatori termostatici ELEGANCE e Q-ELEGANCE vengono progettate e realizzate da Remer Rubinetterie con grande attenzione ai dettagli, utilizzando materiale di alta qualità e tecnologie avanzate, per offrire sempre il massimo del comfort, della sicurezza e del relax.

THERMOSTATICS

A modern comfort dedicated to shower interiors and bathtub designs, the thermostatic mixing allows you to select in advance the water temperature and keep it constant throughout the time of use.

Hot water and cold water are mixed at the desired temperature already inside the thermostatic cartridge. In this way you can enjoy a relaxing shower, avoiding both burns and temperature changes caused by the sudden opening of other taps.

The use of thermostatic mixers also allows you to have greater control over water and energy consumption, saving the amount of water and heat usually wasted looking for the right temperature.

The ELEGANCE and Q-ELEGANCE thermostatic mixers collections are designed and manufactured by Remer Rubinetterie with great attention to detail, using high quality materials and advanced technologies, to always offer the best of comfort, safety and relaxation.

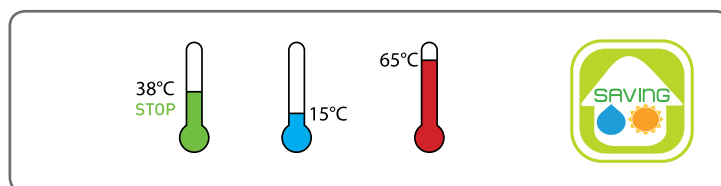

CARATTERISTICHE TECNICHE:

Blocco di sicurezza: 38°C

Campo di lavoro: da 15°C a 65°C

Differenziale termico consigliato 50°C

Campo di pressione in rete: da 1 a 5 bar dinamici

Sistema di sicurezza con blocco dell'erogazione in caso di mancanza di una delle due acque

Filtro in acciaio INOX per il trattamento delle impurità

TECHNICAL FEATURES:

Safety lock: 38°C

Working field: from 15°C to 65°C

Suggested thermic differential between cold and hot water: 50°C

Pressure field: from 1 to 5 bar dynamic

Safety system with the outlet lock in case there is one water lock

Stainless steel filter for the treatment of impurities

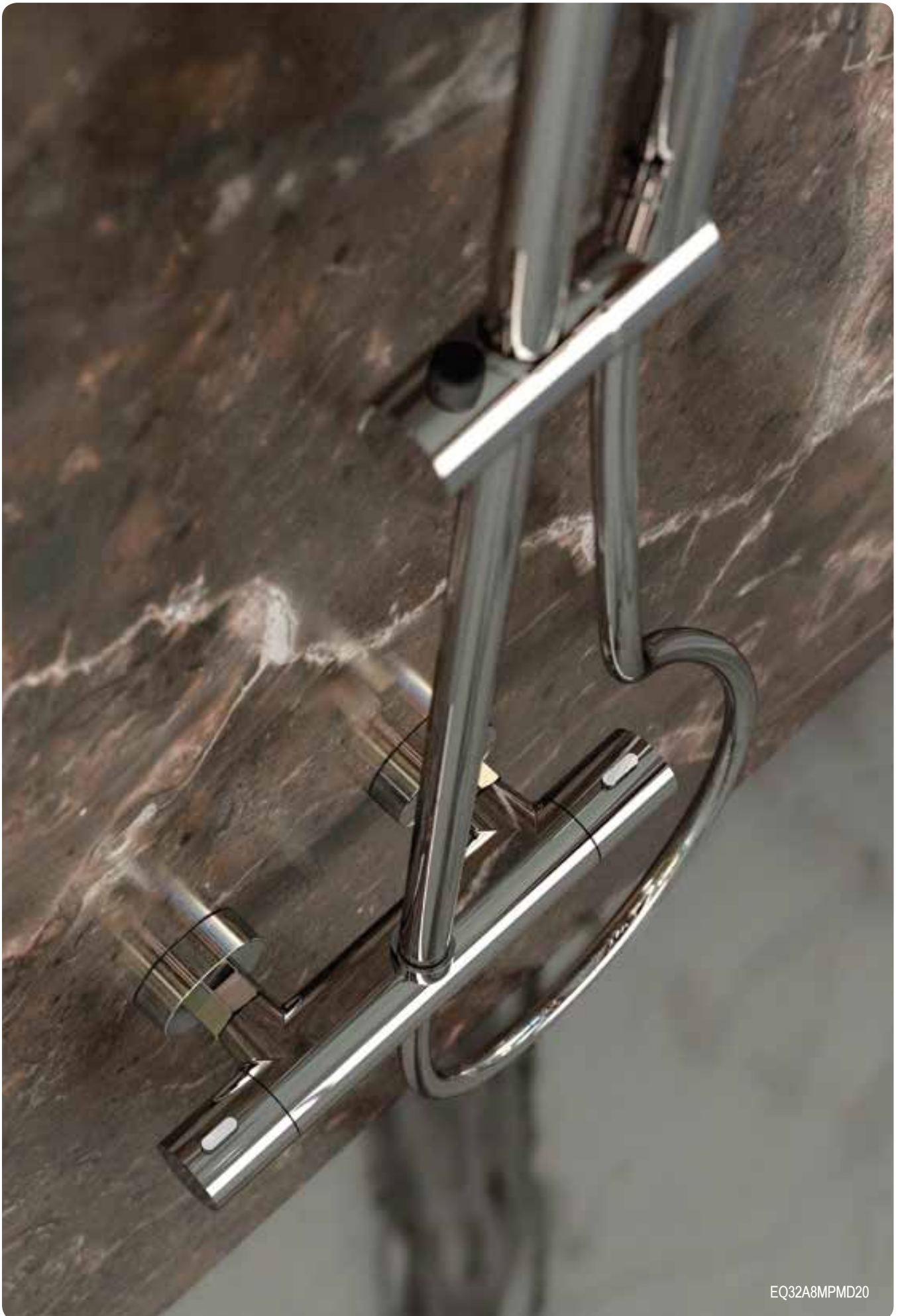

EQ32A8MPMD20

ELEGANCE



La serie è dotata di cartuccia termostatica prodotta da S.T.S.R. - Studio Tecnico Sviluppo e Ricerche www.stsr.it.

The series is equipped with a thermostatic cartridge produced by S.T.S.R. - Technical Development and Research Study www.stsr.it.

ELEGANCE

Q-ELEGANCE



INCASSI TERMOSTATICI - THERMOSTATIC BUILT-IN MIXERS



NT30

Miscelatore termostatico da incasso per doccia completo, senza deviatore.
Complete thermostatic built-in mixer for shower, without diverter.

NT30B

Parte interna miscelatore monocomando incasso doccia.
Single-lever shower mixer (built-in components).

NT30E

Parte esterna miscelatore termostatico monocomando incasso doccia.
Thermostatic single-lever shower mixer (external components).



NT09

Miscelatore termostatico da incasso completo con deviatore per vasca-doccia.
Complete thermostatic built-in single-lever mixer, with diverter for bath-shower.

NT09B

Parte interna miscelatore monocomando incasso vasca/doccia con deviatore.
Single-lever bath/shower mixer with diverter (built-in components).

NT09E

Parte esterna miscelatore termostatico monocomando incasso vasca/doccia con deviatore.
Thermostatic single-lever bath/shower mixer with diverter (external components).



NT92

Miscelatore termostatico per doccia, con deviatore a due posizioni (due uscite ed una entrata) su piastra unica.
Thermostatic shower mixer with 2 positions diverter (2 outlets and 1 inlet) on single flange.



NT93

Miscelatore termostatico per doccia con deviatore a 3 vie (1 entrata e 3 uscite).
Thermostatic built-in shower mixer with 3 ways diverter (1 inlet and 3 outlets).



NT94

Miscelatore termostatico per doccia, con deviatore a 4 posizioni (4 uscite ed 1 entrata).
Thermostatic shower mixer with 4 positions diverter (4 outlets and 1 inlet).



NT94C

Miscelatore termostatico per doccia, con deviatore a 4 posizioni (4 uscite ed 1 entrata), con possibilità di chiusura del flusso dal deviatore durante il cambio di posizione.
Thermostatic shower mixer with 4 positions diverter (4 outlets and 1 inlet), with the possibility of closing the flow from the diverter during the position change.



NT92Q

Miscelatore termostatico per doccia, con deviatore a due posizioni (due uscite ed una entrata) su piastra unica rettangolare.
Thermostatic shower mixer with 2 positions diverter (2 outlets and 1 inlet) on rectangular single flange.



NT93Q

Miscelatore termostatico per doccia con deviatore a 3 vie (1 entrata e 3 uscite).
Thermostatic built-in shower mixer with three ways diverter (1 inlet and 3 outlets) on rectangular single flange.



NT94Q

Miscelatore termostatico per doccia, con deviatore a 4 posizioni (4 uscite ed 1 entrata).
Thermostatic shower mixer with 4 positions diverter (4 outlets and 1 inlet).



NT937Q

Miscelatore termostatico per doccia con deviatore a 3 vie e 7 posizioni (1 entrata, 3 uscite e 7 posizioni con cui selezionare uscite singole o combinate tra loro).
Thermostatic built-in shower mixer with three ways diverter with 7 positions (1 inlet and 3 outlets and 7 positions to select single or combined outlets).

NT95Q

Miscelatore termostatico per doccia, con deviatore a 5 posizioni (5 uscite ed 1 entrata).
Thermostatic shower mixer with 5 positions diverter (5 outlets and 1 inlet).

BOX INCASSO - BUILT-IN BOX MIXERS

ELEGANCE

Q-ELEGANCE



RRBOX
Box da incasso per miscelatore doccia con deviatore.
Built-in box for shower mixer with diverter.

+



NT30KB
Set miscelatore doccia termostatico da abbinare al box incasso.
Thermostatic shower mixer set to match with the built-in box.

OPPURE
OR



NT09KB
Set miscelatore doccia termostatico con deviatore da abbinare al box incasso.
Thermostatic shower mixer set with diverter to match with the built-in box.



RRBOX92
Box da incasso per miscelatore doccia due vie.
Built-in box for two ways shower mixer.

+



NT92KB
Set miscelatore doccia termostatico due vie da abbinare al box incasso.
Thermostatic two ways shower mixer set to match with the built-in box.



RRBOX93
Box da incasso per miscelatore doccia tre vie.
Built-in box for three ways shower mixer.

+



NT93KB
Set miscelatore doccia termostatico tre vie da abbinare al box incasso.
Thermostatic three ways shower mixer set to match with the built-in box.

OPPURE
OR



NT937KB
Set miscelatore doccia termostatico tre vie e sette uscite da abbinare al box incasso.
Thermostatic three ways and seven positions shower mixer set to match with the built-in box.



NT60W
Miscelatore incasso per shut-off comprensivo di: doccetta shut-off, supporto doccia- presa acqua su piastra in ottone e flessibile doccia cm 120.
Built-in shut-off mixer set including: shut off, shower holder water punch on flange, all in brass and shower flexible cm 120.

GRUPPI VASCA E DOCCIA TERMOSTATICI THERMOSTATIC BATH MIXER AND WALL MOUNTED SHOWER MIXERS



Miscelatore termostatico esterno vasca con deviatore integrato.

Thermostatic bath mixer with integrated diverter.

EQ02

con doccetta in ABS anticalcare ad 1 funzione e supporto snodato flessibile 150 cm.
with 1 function antilimestone ABS handshower and swivel shower holder, flexible hose 150 cm.



EQ05

senza kit doccia.
without shower kit.



Miscelatore esterno doccia termostatico con deviatore integrato.

Thermostatic shower mixer with integrated diverter.

EQ32

attacco alto da 1/2" ed attacco inferiore da 1/2".
upper 1/2" connection and lower 1/2" connection.

EQ3234

attacco alto 3/4" ed attacco inferiore da 1/2".
upper 3/4" connection and lower 1/2" connection.

EQ32L

attacco alto da 1/2" ed attacco inferiore da 1/2", maniglie in ottone.
upper 1/2" connection and lower 1/2" connection, handles in brass.

EQ3234L

attacco alto 3/4" ed attacco inferiore da 1/2", maniglie in ottone.
upper 3/4" connection and lower 1/2" connection, handles in brass.



EQ31

Miscelatore esterno doccia termostatico con attacco inferiore da 1/2".

Thermostatic shower mixer, with lower 1/2" connection.



EQ34

Miscelatore esterno doccia termostatico a 3 vie, con attacco superiore da 3/4" inferiore da 1/2".

Thermostatic 3-ways exposed shower mixer, with upper 3/4" connection and lower 1/2" connection.

COLONNE DOCCIA TERMOSTATICHE TELESCOPICHE TELESCOPIC THERMOSTATIC SHOWER COLUMNS



Set doccia composto da: miscelatore termostatico esterno con deviatore, soffione in abs Ø 20cm 354EC20X, colonna doccia in ottone telescopica, altezza asta regolabile 329A, doccetta in abs a 4 funzioni 319MO, flessibile 150 cm.

Shower set including: exposed thermostatic mixer with diverter, abs Ø 20 cm shower head 354EC20X, telescopic brass shower column, with height-adjustable rod 329A, 4-function abs hand shower 319MO, 150 cm flexible hose.

EQ32AEC20



Set doccia composto da: miscelatore termostatico esterno con deviatore, soffione in abs 356MD20X, colonna doccia in ottone telescopica, altezza asta regolabile 329A, doccetta in abs a 4 funzioni 319MO, flessibile 150 cm.

Shower set including: exposed thermostatic mixer with diverter, abs shower head 356MD20X, telescopic brass shower column, with height-adjustable rod 329A, 4-function abs hand shower 319MO, 150 cm flexible hose.

EQ32AMD20

Soffione Ø 20 cm. Shower head Ø 20 cm.

EQ32AMD25

Soffione Ø 25 cm. Shower head Ø 25 cm.

EQ32AMD30

Soffione Ø 30 cm. Shower head Ø 30 cm.





Set doccia composto da: miscelatore termostatico esterno con deviatore, soffione in acciaio inox 357UFM20X, colonna doccia in ottone telescopica, altezza asta regolabile 329A, doccetta in abs a 4 funzioni 319MO, flessibile 150 cm.
Shower set including: exposed thermostatic mixer with diverter, stainless steel shower head 357UFM20X, telescopic brass shower column, with height-adjustable rod 329A, 4-function abs hand shower 319MO, 150 cm flexible hose.

EQ32AUFM20
 Soffione Ø 20 cm.
 Shower head Ø 20 cm.

EQ32AUFM25
 Soffione Ø 25 cm.
 Shower head Ø 25 cm.

EQ32AUFM30
 Soffione Ø 30 cm.
 Shower head Ø 30 cm.



Set doccia composto da: miscelatore termostatico esterno con deviatore, soffione in abs 356MD20X, colonna doccia in ottone telescopica, altezza asta regolabile 329A, doccetta in abs con 4 funzioni 318MP, flessibile 150 cm.
Shower set including: exposed thermostatic mixer with diverter, abs shower head 356MD20X, telescopic brass shower column, with height-adjustable rod 329A, 4-function abs hand shower 318MP, 150 cm flexible hose.

EQ32A8MPMD20
 Soffione Ø 20 cm.
 Shower head Ø 20 cm.

EQ32A8MPMD25
 Soffione Ø 25 cm.
 Shower head Ø 25 cm.

EQ32A8MPMD30
 Soffione Ø 30 cm.
 Shower head Ø 30 cm.



Set doccia composto da: miscelatore termostatico esterno con deviatore, soffione in abs 20x20cm con angoli arrotondati 356AD20X, colonna doccia in ottone telescopica, altezza asta regolabile 329A, doccetta in abs con 4 funzioni 318CP, flessibile 150 cm.
Shower set including: exposed thermostatic mixer with diverter, abs 20x20 cm shower head with rounded corners 356AD20X, telescopic brass shower column, with height-adjustable rod 329A, 4-function abs hand shower 318CP, 150 cm flexible hose.

EQ32A8CPAD20



Set doccia composto da: miscelatore termostatico esterno con deviatore, soffione in acciaio inox con angoli arrotondati 357UFD20X, colonna doccia in ottone telescopica, altezza asta regolabile 329A, doccetta in abs con 4 funzioni 318CP, flessibile 150 cm.
Shower set including: exposed thermostatic mixer with diverter, stainless steel shower head with rounded corners 357UFD20X, telescopic brass shower column, with height-adjustable rod 329A, 4-function abs hand shower 318CP, 150 cm flexible hose.

EQ32A8CPUFD20
 Soffione Ø 20 cm.
 Shower head Ø 20 cm.

EQ32A8CPUFD25
 Soffione Ø 25 cm.
 Shower head Ø 25 cm.

EQ32A8CPUFD30
 Soffione Ø 30 cm.
 Shower head Ø 30 cm.



COLONNE DOCCIA 3 VIE TERMOSTATICHE TELESCOPICHE 3-WAY TELESCOPIC THERMOSTATIC SHOWER COLUMNS



Set doccia composto da: miscelatore termostatico esterno con deviatore vasca/doccia, soffione in abs 356MD20X, colonna doccia in ottone telescopica, altezza asta regolabile 329A, doccetta in abs, 1 funzione 317MD, flessibile 150 cm.
Shower set including: exposed thermostatic mixer with bath/shower diverter, abs shower head 356MD20X, telescopic brass shower column, with height-adjustable rod 329A, 1-function abs hand shower 317MD, 150 cm flexible hose.

EQ34A7MDMD20

Soffione Ø 20 cm.
Shower head Ø 20 cm.

EQ34A7MDMD25

Soffione Ø 25 cm.
Shower head Ø 25 cm.

EQ34A7MDMD30

Soffione Ø 30 cm.
Shower head Ø 30 cm.



Set doccia composto da: miscelatore termostatico esterno con deviatore vasca/doccia, soffione in abs 356SD20X, colonna doccia in ottone telescopica, altezza asta regolabile 329A, doccetta quadrata in ABS, 1 funzione 317SD, flessibile 150 cm.
Shower set including: exposed thermostatic mixer with bath/shower diverter, abs shower head 356SD20X, telescopic brass shower column, with height-adjustable rod 329A, 1-function abs square hand shower 317SD, 150 cm flexible hose.

EQ34A7SDSD20

Soffione 20x20 cm.
Shower head 20x20 cm.

EQ34A7SDSD25

Soffione 25x25 cm.
Shower head 25x25 cm.

EQ34A7SDSD30

Soffione 30x30 cm.
Shower head 30x30 cm.



Set doccia composto da: miscelatore termostatico esterno con deviatore vasca/doccia, soffione in acciaio inox 357UFM20X, colonna doccia in ottone telescopica, altezza asta regolabile 329A, doccetta in abs con 4 funzioni 318MP, flessibile 150 cm.
Shower set including: exposed thermostatic mixer with bath/shower diverter, stainless steel shower head 357UFM20X, telescopic brass shower column, with height-adjustable rod 329A, 4-function abs hand shower 318MP, 150 cm flexible hose.

EQ34A8MPUFM20

Soffione Ø 20 cm.
Shower head Ø 20 cm.

EQ34A8MPUFM25

Soffione Ø 25 cm.
Shower head Ø 25 cm.

EQ34A8MPUFM30

Soffione Ø 30 cm.
Shower head Ø 30 cm.



Set doccia composto da: miscelatore termostatico esterno con deviatore vasca/doccia, soffione quadrato ultrapiatto in acciaio inox lucidato a specchio 357UFS20X, colonna doccia in ottone telescopica con altezza asta regolabile e deviatore 329A, doccetta in abs cromato, 4 funzioni 318CP, flessibile 150 cm.
Shower set including: exposed thermostatic mixer with bath/shower diverter, ultra-flat square shower head in mirror polished stainless steel 357UFS20X, telescopic brass shower column with height-adjustable rod and diverter 329A; 4-function c.p. abs handshower 318CP, 150 cm flexible hose.

EQ34A8CPUFS20

Soffione 20x20 cm.
Shower head 20x20 cm.

EQ34A8CPUFS25

Soffione 25x25 cm.
Shower head 25x25 cm.

EQ34A8CPUFS30

Soffione 30x30 cm.
Shower head 30x30 cm.



ELEGANCE

Q-ELEGANCE



EQ34A8MPUFM20

COLONNE DOCCIA TERMOSTATICHE - THERMOSTATIC SHOWER COLUMNS



Set doccia composto da: miscelatore termostatico esterno con deviatore, soffione in abs Ø 20cm 354EC20X, colonna doccia con fissaggio superiore regolabile in altezza 329X, doccetta in abs a 4 funzioni 319MO, flessibile 150 cm.

Shower set including: exposed thermostatic mixer with diverter, abs Ø 20 cm shower head 354EC20X, shower column with height-adjustable upper fixing 329X, 4-function abs hand shower 319MO, 150 cm flexible hose.

EQ32XEC20



Set doccia composto da: miscelatore termostatico esterno con deviatore, soffione in abs 356MD20X, colonna doccia con fissaggio superiore regolabile in altezza 329X, doccetta in abs a 4 funzioni 319MO, flessibile 150 cm.

Shower set including: exposed thermostatic mixer with diverter, abs shower head 356MD20X, shower column with height-adjustable upper fixing 329X, 4-function abs hand shower 319MO, 150 cm flexible hose.

EQ32XMD20

Soffione Ø 20 cm.
Shower head Ø 20 cm.

EQ32XMD25

Soffione Ø 25 cm.
Shower head Ø 25 cm.

EQ32XMD30

Soffione Ø 30 cm.
Shower head Ø 30 cm.



Set doccia composto da: miscelatore termostatico esterno con deviatore, soffione in acciaio inox 357UFM20X, colonna doccia con fissaggio superiore regolabile in altezza 329X, doccetta in abs a 4 funzioni 319MO, flessibile 150 cm.

Shower set including: exposed thermostatic mixer with diverter, stainless steel shower head 357UFM20X, shower column with height-adjustable upper fixing 329X, 4-function abs hand shower 319MO, 150 cm flexible hose.

EQ32XUFM20

Soffione Ø 20 cm.
Shower head Ø 20 cm.

EQ32XUFM25

Soffione Ø 25 cm.
Shower head Ø 25 cm.

EQ32XUFM30

Soffione Ø 30 cm.
Shower head Ø 30 cm.



Set doccia composto da: miscelatore termostatico esterno con deviatore, soffione in abs 356MD20X, colonna doccia con fissaggio superiore regolabile in altezza 329X, doccetta in abs con 4 funzioni 318MP, flessibile 150 cm.

Shower set including: exposed thermostatic mixer with diverter, abs shower head 356MD20X, shower column with height-adjustable upper fixing 329X, 4-function abs hand shower 318MP, 150 cm flexible hose.

EQ32X8MPMD20

Soffione Ø 20 cm.
Shower head Ø 20 cm.

EQ32X8MPMD25

Soffione Ø 25 cm.
Shower head Ø 25 cm.

EQ32X8MPMD30

Soffione Ø 30 cm.
Shower head Ø 30 cm.



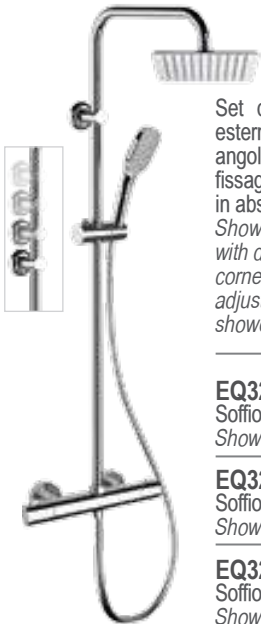

Set doccia composto da: miscelatore termostatico esterno con deviatore, soffione in acciaio inox con angoli arrotondati 357UFD20X, colonna doccia con fissaggio superiore regolabile in altezza 329X, doccetta in abs con 4 funzioni 318CP, flessibile 150 cm.

Shower set including: exposed thermostatic mixer with diverter, stainless steel shower head with rounded corners 357UFD20X, shower column with height-adjustable upper fixing 329X, 4-function abs hand shower 318CP, 150 cm flexible hose.

EQ32X8CPUFD20

Soffione 20x20 cm.
Shower head 20x20 cm.

EQ32X8CPUFD25

Soffione 25x25 cm.
Shower head 25x25 cm.

EQ32X8CPUFD30

Soffione 30x30 cm.
Shower head 30x30 cm.



Set doccia composto da: miscelatore termostatico esterno doccia con deviatore, colonna doccia con fissaggio superiore scorrevole, doccetta anticalcare in ottone cromato (317MM), soffione Ø 20 cm in abs cromato e anticalcare (359MM20X). Flessibile 150cm in ottone cromato incluso.

Shower set including: external thermostatic shower mixer with diverter, shower column with sliding top fixing, chromed brass anti-limescale handshower (317MM), Ø 20 cm chromed and anti-limescale shower head (359MM20X). Flexible 150cm in chromed brass included.

EQ37330U

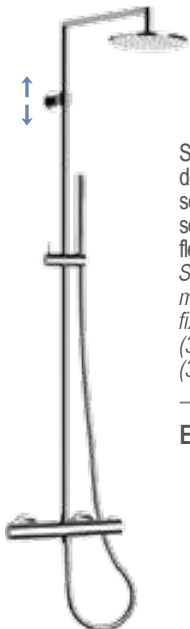

Set doccia composto da: miscelatore termostatico esterno doccia con deviatore, colonna doccia con fissaggio superiore scorrevole, doccetta anticalcare in abs cromato (317DM) e soffione Ø 25 cm in abs cromato anticalcare (356MD25), flessibile 150 cm in ottone cromato incluso.

Shower set including: external thermostatic shower mixer with diverter, shower column with sliding top fixing, anti-limescale hand shower in chromed abs (317DM) and chromed abs shower head Ø 25 cm (356MD25). C.p. brass 150 cm flexible hose included.

EQ37330N



Set doccia composto da: miscelatore termostatico esterno doccia con deviatore, colonna doccia con fissaggio superiore scorrevole, doccetta anticalcare in ottone cromato (317MM), soffione Ø 20 cm in abs cromato anticalcare (359MM20X), flessibile 150 cm in ottone cromato incluso.

Shower set including: external thermostatic shower mixer with diverter, shower column with sliding top fixing, chromed brass anti-limescale hand shower (317MM), anti-limescale chromed abs shower head Ø 20 cm (359MM20X). 150 cm c.p. brass flexible hose included.

EQ37330L





Set doccia composto da: Miscelatore termostatico con deviatore, colonna doccia con fissaggio superiore scorrevole, doccetta 4 funzioni (319MO), soffione in abs Ø20 cm (356MD20X), flessibile 150 cm.
 Shower set including: thermostatic mixer with diverter, shower column with sliding top fixing, 4-function hand shower (319MO), Ø20 cm abs shower head (356MD20X), 150 cm hose.

EQ37330FG



CON OPZIONI DI FINITURA  WITH FINISHING OPTIONS



Set doccia composto da: miscelatore termostatico esterno con deviatore, soffione in ottone 359MM20X, colonna doccia con fissaggio superiore regolabile in altezza 329X, doccetta minimale in ottone, 1 funzione 317MM, flessibile 150 cm.
 Shower set including: exposed thermostatic mixer with diverter, brass shower head Ø 20 cm 359MM20X, shower column with height-adjustable upper fixing 329X, 1-function brass hand shower 317MM, 150 cm flexible hose.

EQ32X7MMM20
 Soffione Ø 20 cm.
 Shower head Ø 20 cm.

EQ32X7MMM30
 Soffione Ø 30 cm.
 Shower head Ø 30 cm.



Set doccia composto da: miscelatore termostatico esterno con deviatore, soffione in ottone Ø 20 cm 359MM20X, colonna doccia girevole in ottone 329U, doccetta minimale in ottone, 1 funzione 317MM, flessibile 150 cm.
 Shower set including: exposed thermostatic mixer with diverter, brass shower head Ø 20 cm 359MM20X, brass swivel shower column 329U, 1-function brass hand shower 317MM, 150 cm flexible hose.

EQ32U



FIN 1 NO BO NP NPO FIN 2 CFP BG DO



EQ32X7MMMM20 (FIN2 - DO)

Q-ELEGANCE



La serie è dotata di cartuccia termostatica prodotta da S.T.S.R. - Studio Tecnico Sviluppo e Ricerche www.stsr.it.

The series is equipped with a thermostatic cartridge produced by S.T.S.R. - Technical Development and Research Study www.stsr.it.

ELEGANCE

Q-ELEGANCE



INCASSI TERMOSTATICI - THERMOSTATIC BUILT-IN MIXERS



QT30

Miscelatore termostatico da incasso per doccia completo, senza deviatore.
Complete thermostatic built-in mixer for shower, without diverter.

NT30B

Parte interna miscelatore termostatico da incasso per doccia, senza deviatore.
Thermostatic single-lever shower mixer (built-in components).

QT30E

Parte esterna miscelatore termostatico da incasso per doccia, senza deviatore.
Single-lever shower mixer (external components).



QT09

Miscelatore termostatico da incasso con deviatore per vasca/doccia completo.
Complete thermostatic built-in single-lever mixer, with diverter for bath-shower.

NT09B

Parte interna miscelatore termostatico da incasso con deviatore per vasca/doccia.
Thermostatic single-lever bath/shower mixer with diverter (built-in components).

QT09E

Parte esterna miscelatore termostatico da incasso con deviatore per vasca/doccia.
Single-lever bath/shower mixer with diverter (external components).



QT92

Miscelatore termostatico per doccia, con deviatore a 2 posizioni (2 uscite ed 1 entrata).
Thermostatic shower mixer with 2 positions diverter (2 outlets and 1 inlet).



QT93

Miscelatore termostatico per doccia con deviatore a 3 vie (1 entrata e 3 uscite).
Thermostatic built-in shower mixer with 3 ways diverter (1 inlet and 3 outlets).



QT94

Miscelatore termostatico per doccia, con deviatore a 4 posizioni (4 uscite ed 1 entrata) su piastra unica.
Thermostatic shower mixer with 4 positions diverter (4 outlets and 1 inlet) on single flange.



QT94C

Miscelatore termostatico per doccia, con deviatore a 4 posizioni (4 uscite ed 1 entrata) su doppia piastra, con possibilità di chiusura del flusso dal deviatore durante il cambio di posizione.
Thermostatic shower mixer with 4 positions diverter (4 outlets and 1 inlet) on double flange, with the possibility of closing the flow from the diverter during the position change.



QT937

Miscelatore termostatico per doccia con deviatore a 3 vie e 7 posizioni (1 entrata, 3 uscite e 7 posizioni con cui selezionare uscite singole o combinate tra loro).
Thermostatic built-in shower mixer with 3 ways diverter and 7 positions (1 inlet and 3 outlets and seven positions to select single or mixed outlets) on single flange.



QT95

Miscelatore termostatico per doccia, con deviatore a 5 posizioni (5 uscite ed una entrata) su piastra unica.
Thermostatic shower mixer with 5 positions diverter (5 outlets and 1 inlet) on single flange.



QT95C

Miscelatore termostatico per doccia, con deviatore a 5 posizioni (5 uscite ed una entrata) su doppia piastra, con possibilità di chiusura del flusso dal deviatore durante il cambio di posizione.
Thermostatic shower mixer with 5 positions diverter (5 outlets and 1 inlet) on double flange, with the possibility of closing the flow from the diverter during the position change.

BOX INCASSO - BUILT-IN BOX MIXERS



RRBOX
Box da incasso per miscelatore doccia con deviatore.
Built-in box for shower mixer with diverter.

+



QT30KB



Set miscelatore doccia termostatico da abbinare al box incasso.
Thermostatic shower mixer set to match with the built-in box.

OPPURE
OR



QT09KB



Set miscelatore doccia termostatico con deviatore da abbinare al box incasso.
Thermostatic shower mixer set with diverter to match with the built-in box.



RRBOX92
Box da incasso per miscelatore doccia due vie.
Built-in box for two ways shower mixer.

+



QT92KB



Set miscelatore doccia termostatico due vie da abbinare al box incasso.
Thermostatic two ways shower mixer set to match with the built-in box.



RRBOX93
Box da incasso per miscelatore doccia tre vie.
Built-in box for three ways shower mixer.

+



QT93KB



Set miscelatore doccia termostatico tre vie da abbinare al box incasso.
Thermostatic three ways shower mixer set to match with the built-in box.



OPPURE
OR



QT937KB



Set miscelatore doccia termostatico tre vie e sette uscite da abbinare al box incasso.
Thermostatic three ways and seven positions shower mixer set to match with the built-in box.



GRUPPI DOCCIA TERMOSTATICI - THERMOSTATIC SHOWER MIXERS



Miscelatore esterno doccia termostatico, forma quadrata, con deviatore incorporato ed attacco alto da 3/4" ed attacco inferiore da 1/2".
Thermostatic shower mixer, squared shape, with integrated diverter, upper 3/4" connection and lower 1/2" connection.

ST32
maniglie in ABS.
handles in ABS.

ST32L
maniglie in ottone.
handles in brass.

COLONNE DOCCIA TERMOSTATICHE - THERMOSTATIC SHOWER COLUMNS



Set doccia composto da: miscelatore termostatico esterno quadrato con deviatore, soffione in abs 356SD20X, colonna doccia con fissaggio superiore regolabile in altezza 329X, doccetta quadrata in ABS, 1 funzione 317SD, flessibile 150 cm.

Shower set including: square exposed thermostatic mixer with diverter, abs shower head 356SD20X, shower column with height-adjustable upper fixing 329X, 1-function abs square hand shower 317SD, 150 cm flexible hose.

ST32X7SDSD20

con soffione in acciaio inox anticalcare 20x20 cm.
with stainless steel antilimestone showerhead 20x20 cm.

ST32X7SDSD25

con soffione in acciaio inox anticalcare 25x25 cm.
with stainless steel antilimestone showerhead 25x25 cm.

ST32X7SDSD30

con soffione in acciaio inox anticalcare 30x30 cm.
with stainless steel antilimestone showerhead 30x30 cm.



Set doccia composto da: miscelatore termostatico esterno quadrato con deviatore, soffione in acciaio inox 357UFS20X, colonna doccia con fissaggio superiore regolabile in altezza 329X, doccetta quadrata in ABS, 1 funzione 317SD, flessibile 150 cm.

Shower set including: square exposed thermostatic mixer with diverter, stainless steel shower head 357UFS20X, shower column with height-adjustable upper fixing 329X, 1-function abs square hand shower 317SD, 150 cm flexible hose.

ST32X7SDUFS20

con soffione in acciaio inox anticalcare 20x20 cm.
with stainless steel antilimestone showerhead 20x20 cm.

ST32X7SDUFS25

con soffione in acciaio inox anticalcare 25x25 cm.
with stainless steel antilimestone showerhead 25x25 cm.

ST32X7SDUFS30

con soffione in acciaio inox anticalcare 30x30 cm.
with stainless steel antilimestone showerhead 30x30 cm.



COLONNE DOCCIA TELESCOPICHE - TELESCOPIC SHOWER COLUMNS



Set doccia composto da: miscelatore termostatico esterno quadrato con deviatore, soffione in abs 356SD20X, colonna doccia in ottone telescopica, altezza asta regolabile 329A, doccetta quadrata in ABS, 1 funzione 317SD, flessibile 150 cm.

Shower set including: square exposed thermostatic mixer with diverter, abs shower head 356SD20X, telescopic brass shower column, with height-adjustable rod 329A, 1-function abs square hand shower 317SD, 150 cm flexible hose.

ST32A7SDSD20

con soffione in acciaio inox anticalcare 20x20 cm.
with stainless steel antilimestone showerhead 20x20 cm.

ST32A7SDSD25

con soffione in acciaio inox anticalcare 25x25 cm.
with stainless steel antilimestone showerhead 25x25 cm.

ST32A7SDSD30

con soffione in acciaio inox anticalcare 30x30 cm.
with stainless steel antilimestone showerhead 30x30 cm.



Set doccia composto da: miscelatore termostatico esterno quadrato con deviatore, soffione in acciaio inox 357UFS20X, colonna doccia in ottone telescopica, altezza asta regolabile 329A, doccetta quadrata in ABS, 1 funzione 317SD, flessibile 150 cm.

Shower set including: square exposed thermostatic mixer with diverter, stainless steel shower head 357UFS20X, telescopic brass shower column, with height-adjustable rod 329A, 1-function abs square hand shower 317SD, 150 cm flexible hose.

ST32A7SDUFS20

con soffione in acciaio inox anticalcare 20x20 cm.
with stainless steel antilimestone showerhead 20x20 cm.

ST32A7SDUFS25

con soffione in acciaio inox anticalcare 25x25 cm.
with stainless steel antilimestone showerhead 25x25 cm.

ST32A7SDUFS30

con soffione in acciaio inox anticalcare 30x30 cm.
with stainless steel antilimestone showerhead 30x30 cm.



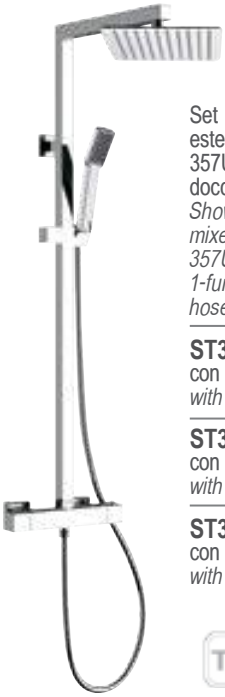

Set doccia composto da: miscelatore termostatico esterno quadrato con deviatore, soffione in acciaio inox 357UFS20X, colonna doccia quadrata in ottone 329S, doccetta in abs a 1 funzione 317SQ, flessibile 150 cm.
Shower set including: square exposed thermostatic mixer with diverter, stainless steel shower head 357UFS20X, square brass shower column 329S, 1-function abs hand shower 317SQ, 150 cm flexible hose.

ST32LS7SQUFS20
 con soffione in acciaio inox anticalcare 20x20 cm.
with stainless steel antilimestone showerhead 20x20 cm.

ST32LS7SQUFS25
 con soffione in acciaio inox anticalcare 25x25 cm.
with stainless steel antilimestone showerhead 25x25 cm.

ST32LS7SQUFS30
 con soffione in acciaio inox anticalcare 30x30 cm.
with stainless steel antilimestone showerhead 30x30 cm.

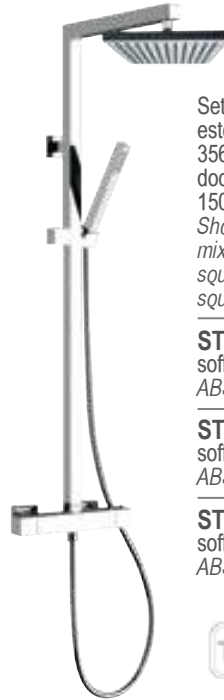

Set doccia composto da: miscelatore termostatico esterno quadrato con deviatore, soffione in abs 356SD20X, colonna doccia quadrata in ottone 329S, doccetta quadrata in ABS, 1 funzione 317SD, flessibile 150 cm.
Shower set including: square exposed thermostatic mixer with diverter, abs shower head 356SD20X, square brass shower column 329S, 1-function abs square hand shower 317SD, 150 cm flexible hose.

ST32S7SDSD20
 soffione in ABS anticalcare 20x20 cm.
ABS antilimestone showerhead 20x20 cm.

ST32S7SDSD25
 soffione in ABS anticalcare 25x25 cm.
ABS antilimestone showerhead 25x25 cm.

ST32S7SDSD30
 soffione in ABS anticalcare 30x30 cm.
ABS antilimestone showerhead 30x30 cm.



CON OPZIONI DI FINITURA WITH FINISHING OPTIONS



Set doccia composto da: miscelatore termostatico esterno quadrato con deviatore, soffione in ottone 20x20cm 359SSX, colonna doccia con fissaggio superiore regolabile in altezza 329X, doccetta quadrata in ottone a 1 funzione 317SS, flessibile 150 cm.
Shower set including: square exposed thermostatic mixer with diverter, brass shower head 20x20cm 359SSX, shower column with height-adjustable upper fixing 329X, 1-function brass square hand shower 317SS, 150 cm flexible hose.

ST32LX7SS9SS

ST32LX7SSSSL



Set doccia composto da: miscelatore termostatico esterno quadrato con deviatore, soffione in ottone 20x20cm 359SSX, colonna doccia quadrata in ottone 329S, doccetta quadrata in ottone a 1 funzione 317SS, flessibile 150 cm.
Shower set including: square exposed thermostatic mixer with diverter, brass shower head 20x20cm 359SSX, square brass shower column 329S, 1-function brass square hand shower 317SS, 150 cm flexible hose.

ST32LS7SS9SS

ST32LS7SSSSL



FIN 1

NO

BO

NP

NPO

FIN 2

CFP

BG

DO

DESIGN

DESIGN MINIMALE - MINIMAL DESIGN

CONTRACT

CLASSICA - CLASSIC

TERMOSTATICI - THERMOSTATICS

SENSOR & TEMPOR

ACCESSORI - ACCESSORIES



SENSOR

pag. 252



SENSOR COLOR

pag. 262



TEMPOR TOUCH

pag. 266



TEMPOR

pag. 270

SENSOR

SENSOR



SENSOR è una collezione di rubinetteria con sensore a infrarossi dedicata agli ambienti pubblici per il controllo dei consumi, il risparmio idrico e la sicurezza. L'utilizzo della rubinetteria avviene senza nessun contatto da parte dell'utente, garantendo quindi un alto livello di igiene anche nelle aree ad alto passaggio.

SENSOR is a collection of infrared sensor taps dedicated to public spaces for consumption control, water saving and safety. These touchless taps do not require any contact from the user, ensuring a high level of hygiene even in high-traffic areas.



SENSOR

SENSOR COLOR

TEMPOR TOUCH

TEMPOR

RUBINETTERIA CON SENSORE A INFRAROSSI

L'utilizzo di una rubinetteria con sensore a infrarossi promuove il risparmio idrico negli ambienti pubblici, limitando i tempi di utilizzo dell'acqua alla sola necessità effettiva. La tecnologia a sensore permette inoltre di evitare qualsiasi contatto tra il rubinetto e l'utente, garantendo un alto livello di igiene anche nelle aree ad alto passaggio. Remer Rubinetterie propone una gamma completa di prodotti con tecnologia a sensore, capace di soddisfare ogni esigenza progettuale sia in termini di stile che di funzionalità. Come scegliere il rubinetto a sensore ideale? L'alta affidabilità della tecnologia a infrarossi viene proposta in molteplici varianti di design, dalle linee basiche alle forme più raffinate per integrarsi anche con gli arredi più esclusivi. I modelli sono di seguito suddivisi per tipologia di alimentazione: a batterie o con presa elettrica.

Descrizioni e simbologia vi guideranno nella scelta della soluzione più adatta al vostro progetto tra i modelli mono-acqua, con leva di regolazione della temperatura calda/fredda oppure con acqua a temperatura fissa pre-miscelata tramite rubinetti sotto-lavabo. Ogni prodotto è dotato di tutta l'elettronica e della componentistica necessarie al funzionamento, come ad esempio i rubinetti per la regolazione sotto-lavabo e le batterie.

Per evitare che le impurità dell'acqua entrino in contatto con la meccanica e per preservare la qualità del prodotto nel tempo, la rubinetteria include sistemi di filtraggio e/o prevede l'installazione di rubinetti di arresto con filtri per la pulizia dell'acqua in ingresso. Tutti i sensori sono dotati di funzionalità anti-vandalo che blocca automaticamente l'erogazione dell'acqua al superamento di un periodo di tempo prefissato e personalizzabile (a seconda del modello).

Una scelta di qualità .

Ogni modello di rubinetteria a sensore per lavabo viene progettato e prodotto in Italia all'interno degli stabilimenti di Remer Rubinetterie e integra un'elettronica prodotta dall'azienda italiana S.T.S.R. (S.T.S.R. - Studio Tecnico Sviluppo e Ricerche - Lacchiarella - Milano) a garanzia di affidabilità e durata nel tempo. Tutti i prodotti risultano conformi agli standard della certificazione CE.

INFRARED SENSOR TAPS

Using an infrared sensor tap promotes water saving in public environments, limiting the water consumption to the actual need only. The sensor technology also avoids any contact between the tap and the user, ensuring a high level of hygiene even in frequent passage areas. Remer Rubinetterie offers a complete range of faucets with sensor technology, capable of satisfying every design need both in terms of style and functionality. How to choose the perfect sensor tap? The high reliability of infrared sensor technology is proposed in multiple design variants, from basic lines to more refined shapes to integrate with even the most exclusive furnishings. The faucet models in this document are firstly sorted by the type of supply: batteries or electrical plug.

Descriptions and symbols will also guide you in choosing the most suitable solution for your project among the models with mono-water supply, with hot / cold temperature adjustment or with a fixed temperature of pre-mixed water via under-sink angle valves. Each product is equipped with all the electronics and components necessary for operation, such as angle valves for under-sink adjustment and batteries.

To prevent the impurities of the water from coming into contact with the mechanics and to preserve the quality of the product over time, the taps include filtering systems and/or require the installation of stopcocks with filters for cleaning the inlet water . All sensors are equipped with anti-vandal functionality that automatically blocks the water supply after exceeding a predetermined and customizable (depending on the model) period of time.

A choice of quality .

Each sensor basin mixer model is designed and produced in Italy within Remer Rubinetterie's factories and integrates electronics provided by the Italian company S.T.S.R. (S.T.S.R. - Technical Development and Research Studio - Lacchiarella - Milan) to guarantee reliability and durability. All products comply with CE certification standards.



ALIMENTAZIONE BATTERIA - BATTERY POWER SUPPLY



Pressione di lavoro: 1 --> 6 Bar

Temperatura acqua: 65° C max

Diametro di entrata: Ø G 1/2 M

Raggio d'azione di riconoscimento: 10 cm circa, predisposto

Alimentazione elettrica: 4 batterie litio da 1,5 V tipo AA

Portabatterie adesivizzabile IPX5

Conessioni IPX5

Working pressure: 1-6 Bar

Water temperature max: 65° C max

Input: Ø G 1/2 M

Recognition range: about 10 cm adjustable

Electrical connection: 4 lithium 1,5 V batteries type AA

Adhesive Battery Holder IPX5

IPX5 connections



SE17I

Rubinetto elettronico ad azionamento a sensore con regolazione acqua caldo/freddo tramite due rubinetti sottolavabo con filtro.

Electronic tap, with sensor control, for pre-mixed water equipped with two angle valves with filter.



SE17IL

Rubinetto alto elettronico ad azionamento a sensore con regolazione acqua caldo/freddo tramite due rubinetti sottolavabo con filtro.

Electronic high tap, with sensor control, for pre-mixed water equipped with two angle valves with filter.

SE16I

Rubinetto elettronico ad azionamento a sensore, mono-acqua dotato di rubinetto sottolavabo con filtro.

Electronic single water tap, with sensor control, equipped with angle valve with filter.

SE16IL

Rubinetto alto elettronico ad azionamento a sensore, mono-acqua dotato di rubinetto sottolavabo con filtro.

Electronic high single water tap, with sensor control, equipped with angle valve with filter.

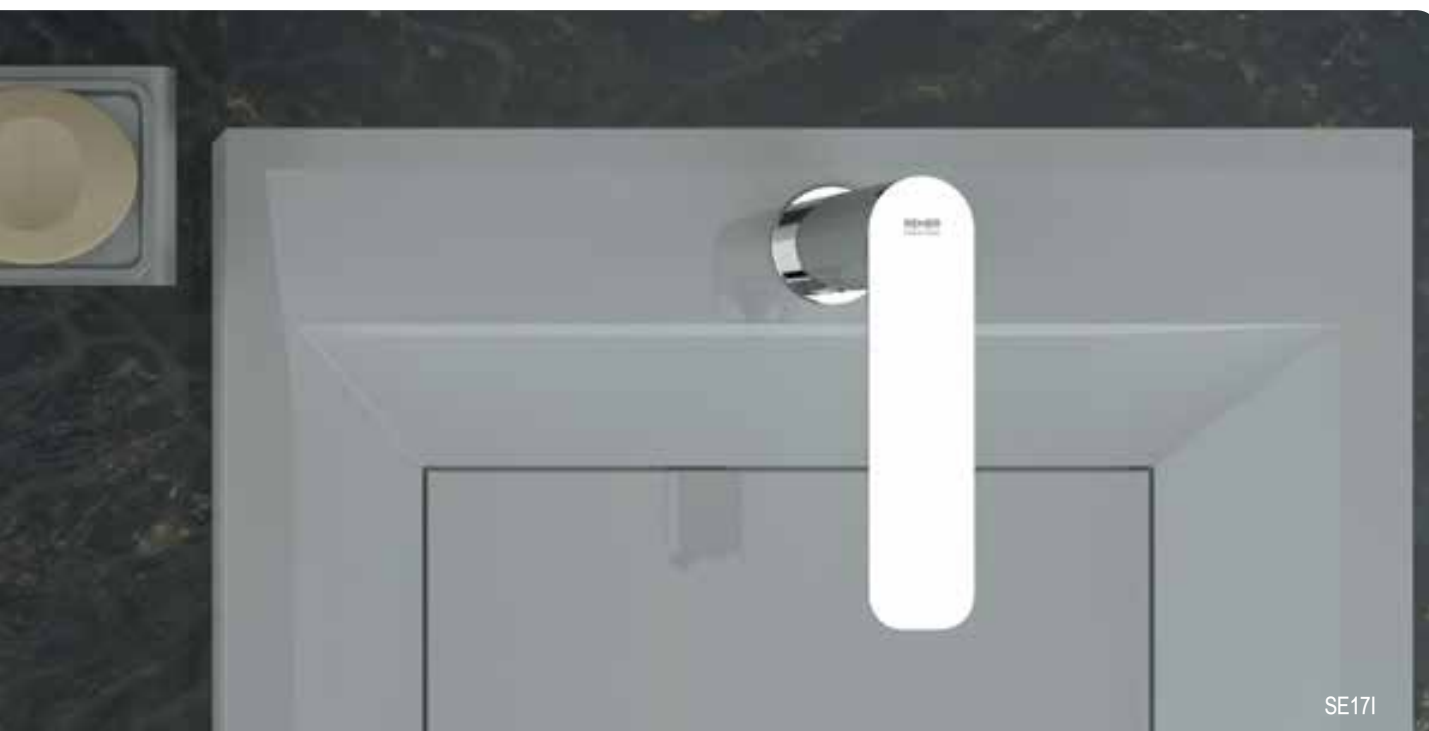

SE17I

SENSOR

SENSOR COLOR

TEMPOR TOUCH

TEMPOR

SENSOR

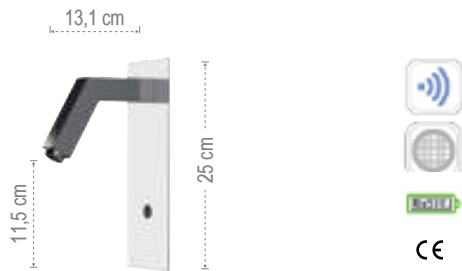

SE28

Rubinetto lavabo ad incasso a sensore, monoacqua o premiscelata, interasse 13,1 cm.
Built in wash basin sensor mixer, single water or premixed, interaxis 13,1 cm.



SE28Q

Rubinetto lavabo ad incasso a sensore, monoacqua o premiscelata.
Built in wash basin sensor mixer, single water or premixed.



SE18

Miscelatore elettronico lavabo ad azionamento a sensore, con regolazione acqua caldo/freddo, rubinetti sottolavabo con filtri inclusi.
Sensor control basin mixer with hot/cold water adjustment lever, angle valves, with filter included.

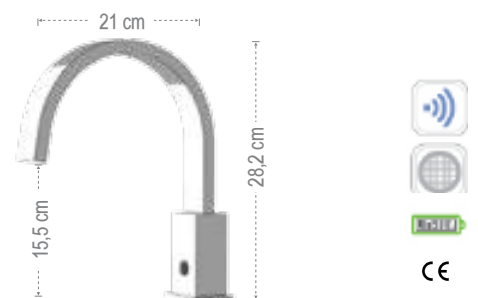

SE25

Rubinetto elettronico ad azionamento a sensore con regolazione acqua caldo/freddo tramite due rubinetti sottolavabo, con filtri inclusi.
Sensor control basin tap with hot/cold water setting by two angle valves, with filter included.



SE25



SE15

Rubinetto elettronico con azionamento a sensore ad acqua singola con rubinetto sottolavabo con filtro incluso.
Sensor control basin tap with single water, angle valve with filter included.



SE15B

Rubinetto elettronico ad azionamento a sensore ad acqua singola con basetta con rubinetto sottolavabo con filtro incluso.
Sensor control basin tap with single water and with base, angle valve with filter included.



SE14

Miscelatore elettronico ad azionamento a sensore, con regolazione acqua caldo/freddo con rubinetto sottolavabo con filtro incluso.
Sensor control mixer, with hot/cold water adjustment lever, angle valve with filter included.



SE14B

Miscelatore elettronico ad azionamento a sensore con regolazione acqua caldo/freddo con basetta con rubinetto sottolavabo con filtro incluso.
Sensor control mixer, with hot/cold water adjustment lever with base, angle valve with filter included.

SENSOR

SENSOR COLOR

TEMPOR TOUCH

TEMPOR



SE14B

SENSOR



SE17L

Rubinetto alto elettronico ad azionamento a sensore con regolazione acqua caldo/freddo tramite due rubinetti sottolavabo con filtro.
High electronic tap, with sensor control, for pre-mixed water equipped with two angle valves with filter.



SE17

Rubinetto elettronico ad azionamento a sensore con regolazione acqua caldo/freddo tramite due rubinetti sottolavabo con filtro.
Electronic tap, with sensor control, for pre-mixed water equipped with two angle valves with filter.

SE16L

Rubinetto alto elettronico ad azionamento a sensore, mono-acqua dotato di rubinetto sottolavabo con filtro.
High electronic single water tap, with sensor control, equipped with angle valve with filter.

SE16

Rubinetto elettronico ad azionamento a sensore, mono-acqua dotato di rubinetto sottolavabo con filtro.
Electronic single water tap, with sensor control, equipped with angle valve with filter.



ALIMENTAZIONE ELETTRICA - ELECTRICAL POWER SUPPLY



Pressione di lavoro: 1 --> 6 Bar

Temperatura acqua: 65° C max

Diametro di entrata: Ø G 1/2 M

Raggio d'azione di riconoscimento: 10 cm circa, predisposto

2 modalità di funzionamento selezionabili (basso consumo/alta reattività)

Omologazione CE

Conessioni IP67

Working pressure: 1-6 Bar

Water temperature max: 65° C max

Input: Ø G 1/2 M

Recognition range: about 10 cm adjustable

2 selectable operation modes (low-consumption/high reactivity)

CE approved

IP67 connections

SENSOR

SENSOR COLOR

TEMPOR TOUCH

TEMPOR



SE117L

Rubinetto elettronico alto per lavabo con azionamento a sensore, per acqua premiscelata, dotato di due rubinetti sottolavabo con filtro.

High electronic tap, with sensor control, for pre-mixed water equipped with two angle valves with filter.



SE117

Rubinetto elettronico per lavabo con azionamento a sensore, per acqua premiscelata, dotato di due rubinetti sottolavabo con filtro.

Electronic tap, with sensor control, for pre-mixed water equipped with two angle valves with filter.

SE116L

Rubinetto elettronico alto mono-acqua per lavabo con azionamento a sensore, dotato di rubinetto sottolavabo con filtro.

High electronic single water tap, with sensor control, equipped with angle valve with filter.

SE116

Rubinetto elettronico mono-acqua per lavabo con azionamento a sensore, dotato di rubinetto sottolavabo con filtro.

Electronic single water tap, with sensor control, equipped with angle valve with filter.

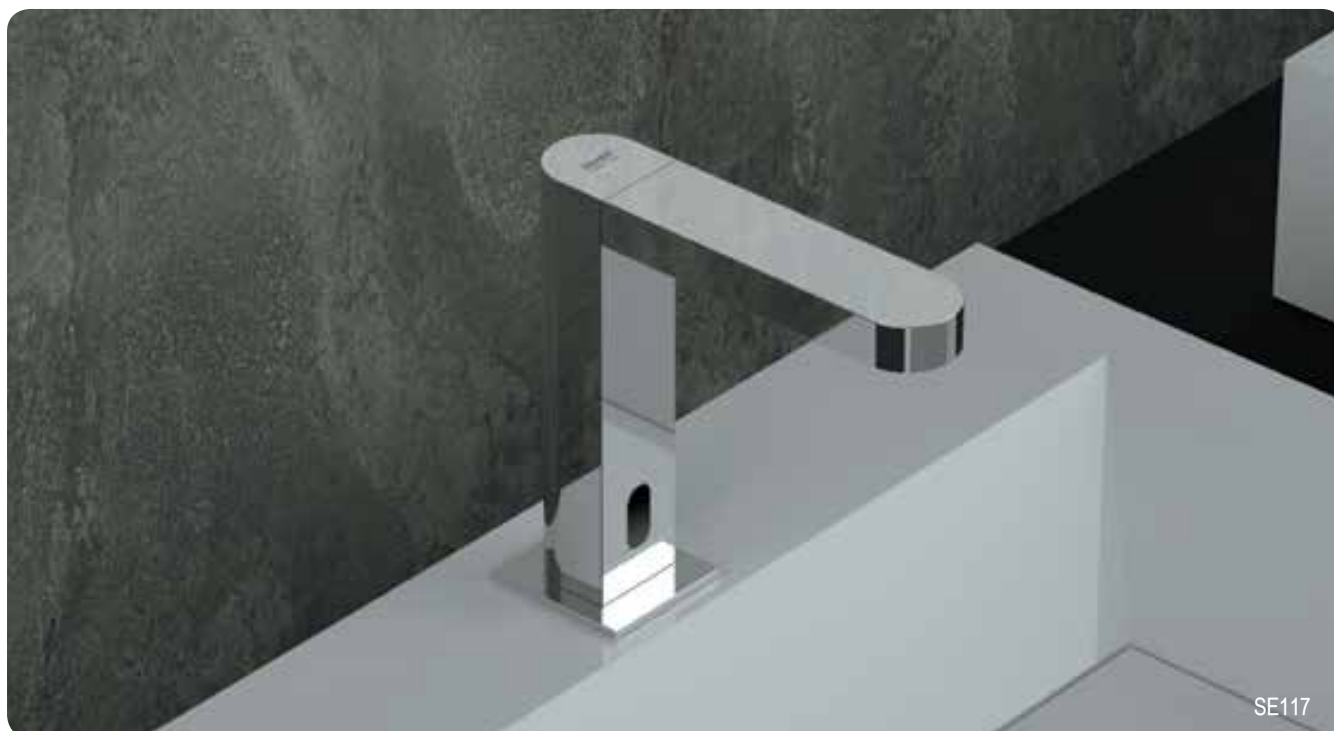

SE117

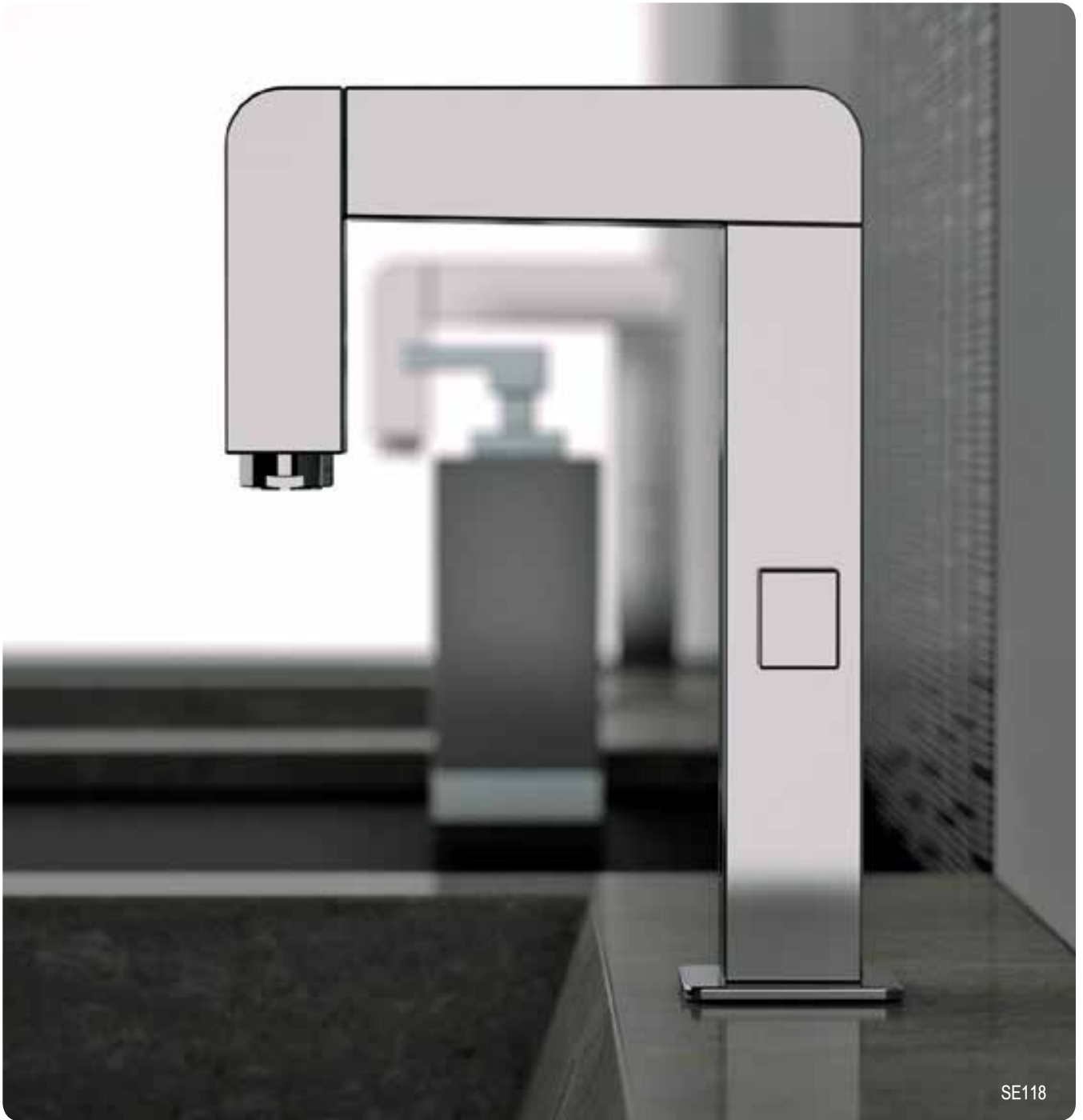

SE118

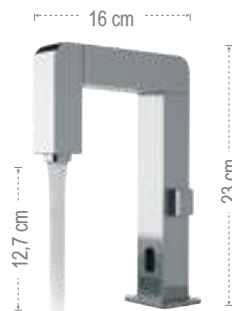

CE

SE118

Miscelatore elettronico lavabo ad azionamento a sensore, con regolazione acqua caldo/freddo, rubinetti sottolavabo con filtri inclusi.

Sensor control basin mixer with hot/cold water adjustment lever, angle valves, with filter included.

ARTICOLI COMPLEMENTARI - COMPLEMENTARY ITEMS



SE30
Rubinetto elettronico a incasso per orinatoio.
Urinal electronic built-in flusher.

Pressione di lavoro: 1 – 6 Bar
Diametro di entrata: G1/2
Azionamento: elettrovalvola integrata
Raggio d'azione di riconoscimento: 30 – 60 cm, regolabile
Alimentazione elettrica: DC 4.5V tre batterie alcaline "AAA" da 1.5V
Installazione: montaggio ad incasso.

Working pressure: 1-6 Bar
Input: Ø G 1/2
Control valve: solenoid valve
Recognition range: 30-60 cm adjustable
Electrical connection: DC 4.5 V with 3 1,5 V alkaline batteries type AAA
Installation: built-in



SE33
Rubinetto elettronico esterno per orinatoio.
Urinal electronic external flusher.

Pressione di lavoro: 1 – 6 Bar
Diametro di entrata: G1/2
Raggio d'azione di riconoscimento: 35 cm, predisposto.
Alimentazione elettrica: DC 6V quattro batterie alcaline "AAA" da 1.5V
Modalità di installazione: esterno

Working pressure: 1-6 Bar
Input: Ø G 1/2
Recognition range: 35 cm adjustable
Electrical connection: DC 6V with 4 1,5 V alkaline batteries type AAA
Installation: external mounted



SE71
Dispenser a sensore per sapone liquido e liquido disinfettante.
Sensor dispenser for liquid soap and liquid disinfectant.

Capacità: 650 ml
Batteria: 6 x 1,5 V
Capacity: 650 ml
Battery: 6 x 1,5 V



SEPKIT
Kit composto da:
connettore per alimentazione elettrica dei dispositivi elettronici, con commutazione automatica a batteria in caso di mancanza energia elettrica ed alimentatore a 6V, in scatola (da utilizzare con batterie alcaline).
Kit composed of:
power supply joiner with battery back-up function and power supply 6V, in box (for use with alkaline batteries).

SENSOR

SENSOR COLOR

TEMPOR TOUCH

TEMPOR

SENSOR COLOR

SENSOR COLOR



I modelli di rubinetteria a sensore SENSOR COLOR si rivolgono agli ambienti pubblici più prestigiosi, aggiungendo una scenografica luce led alle funzionalità di igiene e controllo dei consumi.

SENSOR COLOR tap models are created for the most exclusive public spaces, adding a spectacular LED light to the hygiene and consumption control functions.

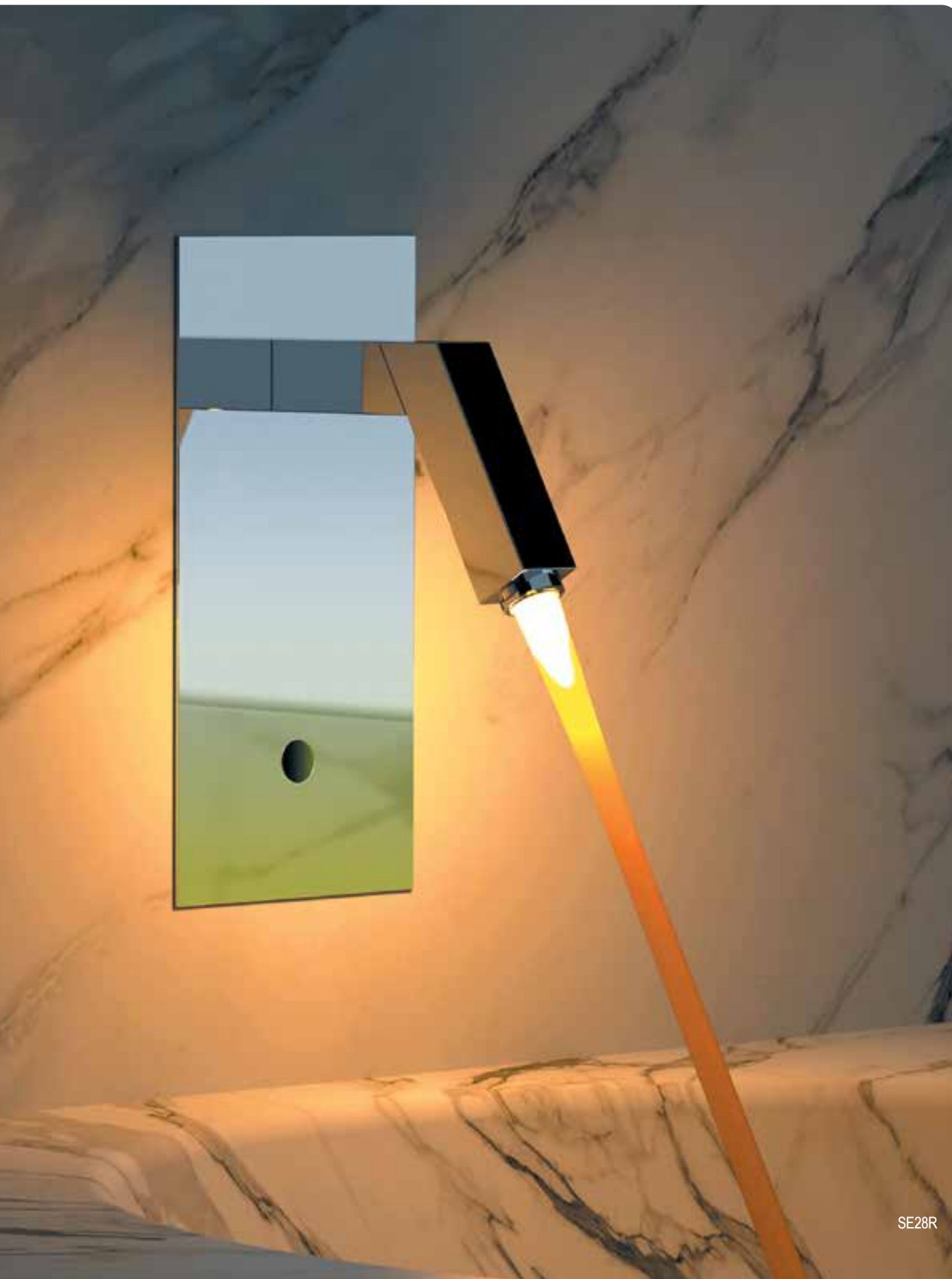

SENSOR

SENSOR COLOR

TEMPOR TOUCH

TEMPOR

RUBINETTERIA A SENSORE CON LUCE LED

Nei modelli di rubinetteria SENSOR COLOR di Remer Rubinetterie, l'efficienza della tecnologia a sensore infrarossi viene personalizzata da un'originale luce led colorata. Grazie alla tecnologia COLOR LED LIGHT all'interno del miscelatore, infatti, il semplice passaggio dell'acqua genera una delicata luce bianca o multi colore che ne accompagna il fluire e che si diffonde nello spazio circostante. Ogni prodotto include tutta l'elettronica e la componentistica necessarie al funzionamento.

SENSOR TAPS WITH LED LIGHT

With SENSOR COLOR faucets by Remer Rubinetterie, the efficiency of the infrared sensor technology is featured by an original colored LED light. Thanks to the COLOR LED LIGHT technology inside the mixer, the simple passage of water generates a delicate white or multi-colored light that follows the flow and spreads into the surrounding space. Each product includes all the electronics and components necessary for operation.

TECNOLOGIA COLOR LED LIGHT

La tecnologia COLOR LED LIGHT inserita nei modelli SENSOR COLOR é disponibile in quattro varianti di performance led:

COLOR LED LIGHT TECHNOLOGY

COLOR LED LIGHT technology is available in four LED performance variants:

A ■

La luce emanata è solo bianca
The emitted light is white only

B ■ ■ ■ ■

Il colore della luce cambia con la temperatura dell'acqua (Azzurro: fino a 32° Bianco : da 32° a 38° Rosa: oltre 38°)

The color of the light changes following the water temperature (Light blue: up to 32°, White: from 32° to 38°, Pink: over 38°)

C ■ ■ ■ ■ ■ ■

Il colore della luce cambia con la temperatura dell'acqua (Blu: fino a 28°, Verde: da 28° a 33°, Giallo: da 33° a 38°, Rosso: da 38°)

The color of the light changes following the water temperature (Blue: up to 28°, Green: from 28° to 33°, Yellow: from 33° to 38°, Red: from 38°)

D ■ ■ ■ ■ ■ ■ ■ ■ ■ ■

8 colori e sfumature si alternano in un continuo arcobaleno, indipendentemente dalla temperatura.
8 colors and shades alternate in a continuous rainbow, regardless of the temperature



Le temperature indicate possono variare di circa +/-2 gradi. Per confermare la variante prescelta, aggiungere la lettera corrispondente alla fine del codice prodotto al momento dell'ordine.

Temperatures may vary by approximately +/- 2 degrees. To confirm the chosen variant, add the corresponding letter at the end of the item code during the purchase phase.

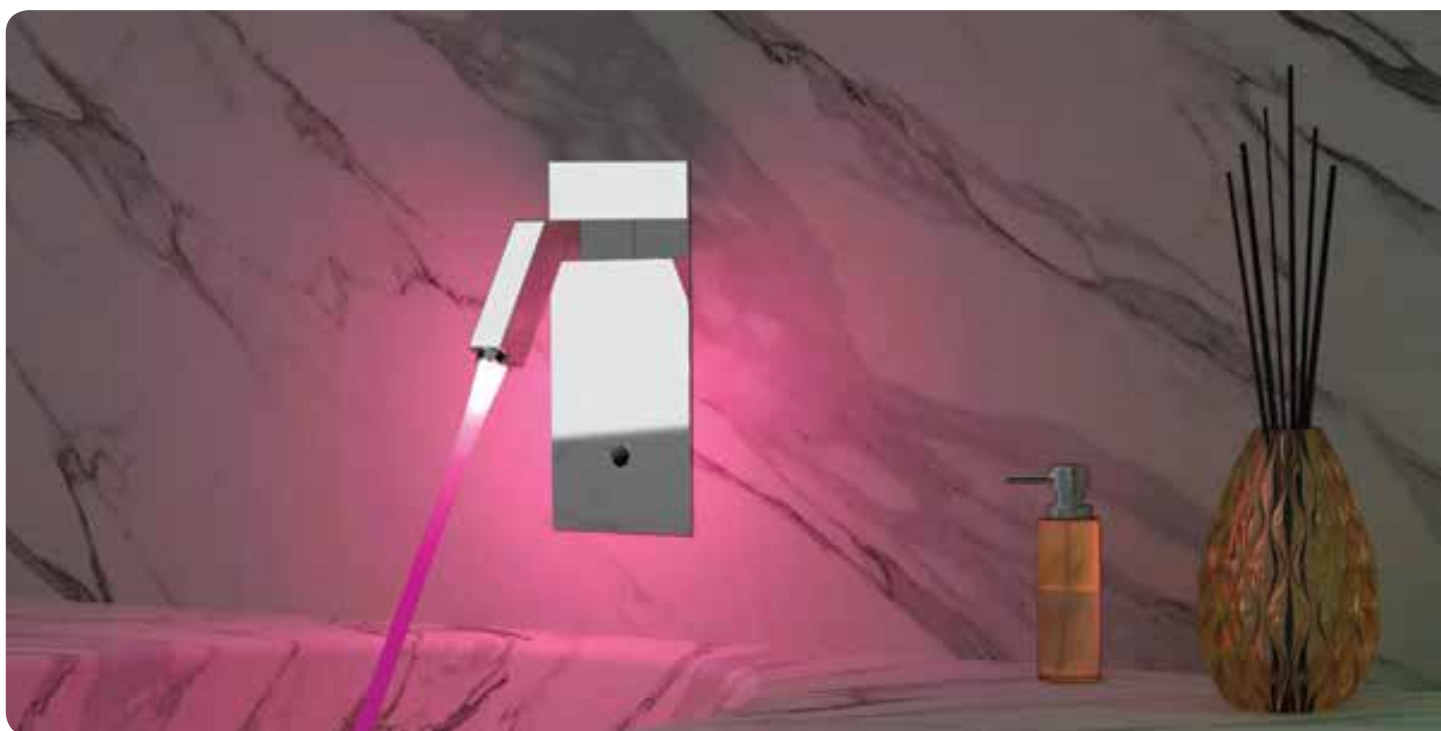

LUCE LED A COLORI - COLOR LED LIGHT



Pressione di lavoro: 1 --> 6 Bar

Temperatura acqua: 65° C max

Diametro di entrata: Ø G 1/2 M

Raggio d'azione di riconoscimento: 10 cm circa, predisposto

Portabatterie adesivizzabile IPX5

Connessioni IPX5

Working pressure: 1-6 Bar

Water temperature max: 65° C max

Input: Ø G 1/2 M

Recognition range: about 10 cm adjustable

Adhesive Battery Holder IPX5

IPX5 connections

SENSOR

SENSOR COLOR

TEMPOR TOUCH

TEMPOR



SE28R

Rubinetto lavabo ad incasso a sensore, con luce led, monoacqua o premiscelata.
Built in wash basin sensor mixer, single water or premixed, with color device.



SE18R

Rubinetto elettronico ad azionamento a sensore con cromoterapia dotato di microturbina e tecnologia LED. La luce cambia in funzione della temperatura dell'acqua, dal freddo blu al caldo rosso, passando per il verde con acqua miscelata. e regolazione acqua caldo/freddo attraverso il rubinetto sottolavabo con filtro incluso.
Sensor control basin tap with colortherapy with microturbine and LED technology. The light changes with the water temperature, from cold blue to hot red, passing through green mixed water. With hot/cold water adjustment lever, angle valve with filter included.



SE118R

Rubinetto elettronico ad azionamento a sensore con cromoterapia dotato di microturbina e tecnologia LED. La luce cambia in funzione della temperatura dell'acqua, dal freddo blu al caldo rosso, passando per il verde con acqua miscelata. e regolazione acqua caldo/freddo attraverso il rubinetto sottolavabo con filtro incluso.
Sensor control basin tap with colortherapy with microturbine and LED technology. The light changes with the water temperature, from cold blue to hot red, passing through green mixed water. With hot/cold water adjustment lever, angle valve with filter included.

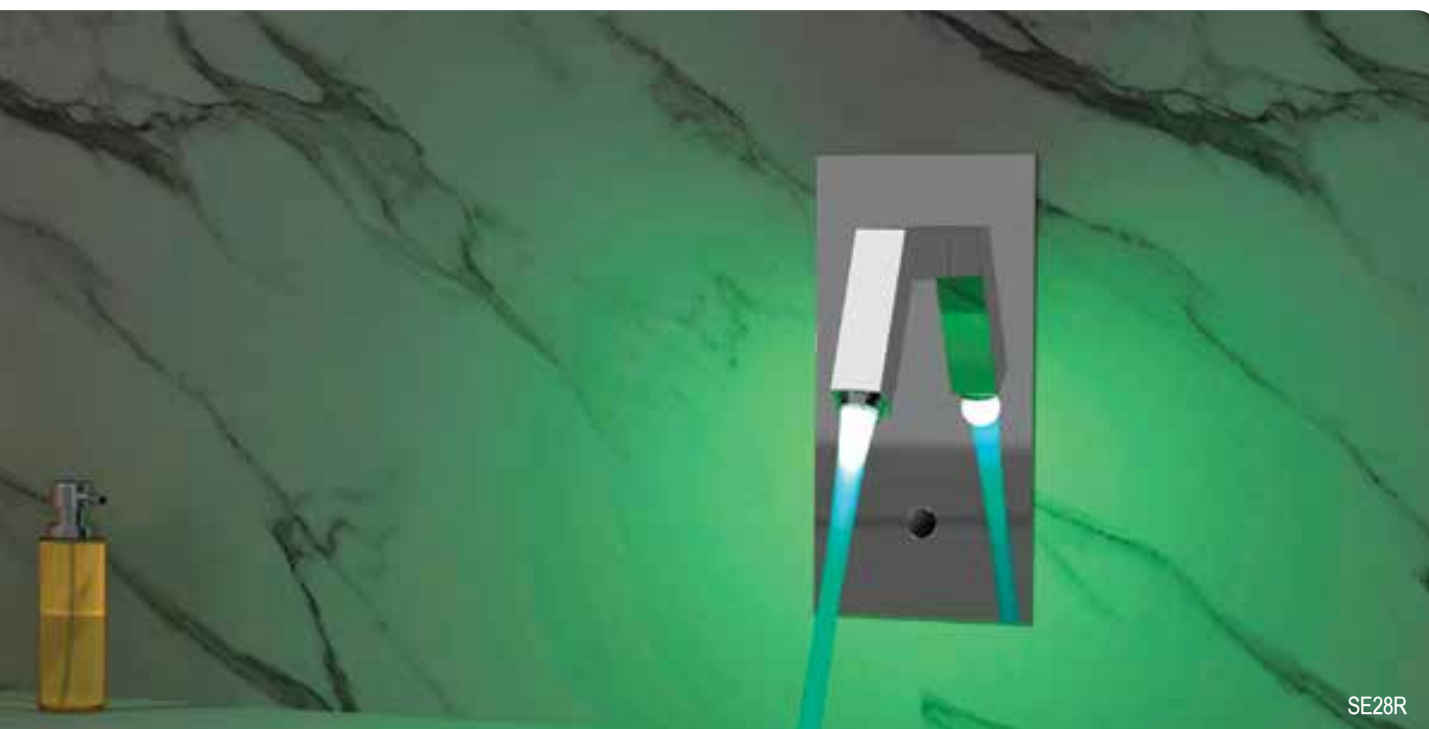

SE28R

TEMPOR TOUCH

TEMPOR TOUCH



La tecnologia TEMPOR TOUCH rinforza le collezioni di Remer Rubinetterie dedicate agli ambienti pubblici offrendo un'alternativa elettronica alla temporizzazione tradizionale. L'erogazione dell'acqua viene infatti attivata con una leggera pressione di un tasto piezoelettrico posizionato sulla cima del miscelatore. Il flusso viene poi automaticamente interrotto dopo un periodo di tempo prestabilito e personalizzabile oppure premendo una seconda volta il tasto di avvio.

The TEMPOR TOUCH Technology strengthens the collections of Remer Rubinetterie dedicated to public spaces, offering an electronic alternative to the traditional timing. The water supply is activated with a slight pressure of a piezoelectric button positioned on the top of the mixer. The flow is then automatically stopped after a predetermined and customizable period of time or by pressing a second time the start button.



SENSOR

SENSOR COLOR

TEMPOR TOUCH

TEMPOR

TECNOLOGIA PIEZO

La temporizzazione elettronica dei modelli TEMPOR TOUCH si avvale della tecnologia di attivazione PIEZO.

L'erogazione dell'acqua si attiva tramite la pressione di un pulsante piezoelettrico e si interrompe automaticamente dopo un periodo o su richiesta con una successiva pressione del tasto.

La versione a due tempi opera nella stessa maniera permettendo all'utente la selezione della temporizzazione prima della apertura della valvola attraverso una o due pressioni del tasto con relativo feedback ottico (due diversi colori di luce led anziché uno della versione mono tempo).

La tecnologia impiegata da questo prodotto si contraddistingue dalla capacità di elevare il livello di precisione e sicurezza, e di assicurare le prestazioni desiderate anche su installazioni multiple e/o in linea.

La versione ad un solo tempo è suggerita in luoghi in cui gli utenti cambiano costantemente (aeroporti, scuole, bagni pubblici etc) mentre la versione a due tempi è suggerita in luoghi in cui gli utenti sono comunemente un gruppo costante (uffici, installazioni private, laboratori e studi medici etc).

VERSIONE 1 TEMPO

Preimpostato di fabbrica a 10 secondi circa
(erogazione istantanea a fronte della pressione del tasto)

VERSIONE 2 TEMPI

Preimpostata di fabbrica a circa 10 secondi (tempo 1) e circa 20 secondi (tempo 2). Un piccolo ritardo nell'erogazione di circa 1 secondo e mezzo consente all'utente di effettuare la selezione necessaria.

PIEZO TECHNOLOGY

The electronic timing of TEMPOR TOUCH models uses PIEZO activation technology.

The water supply is activated by pressing a piezoelectric button and automatically stops after a while or upon request with a further subsequent pressing.

The two-timings version operates in the same way, allowing the user to select the desired timing before the valve opening through one or two button pressures and includes an optical feedback (two different led light colors instead of one of the single-timing version)

The technology employed in this product stands out thanks to its ability to elevate the level of precision and safety, and to ensure the desired performance even on multiple installations and/or on line.

The single-timing product is suggested where the user is always changing (airports, public toilets, etc) while the two-timing version is suggested where the users are commonly the same group (offices, home use, laboratories, medicals, etc).

1 TIMING VERSION

*10 seconds around
(instantaneous water flow after the user press the button).*

2 TIMING VERSION

*Around 10 seconds first timing, around 20 seconds second timing
(a slight delay of about 1,5 seconds allows the user to select the necessary timing).*

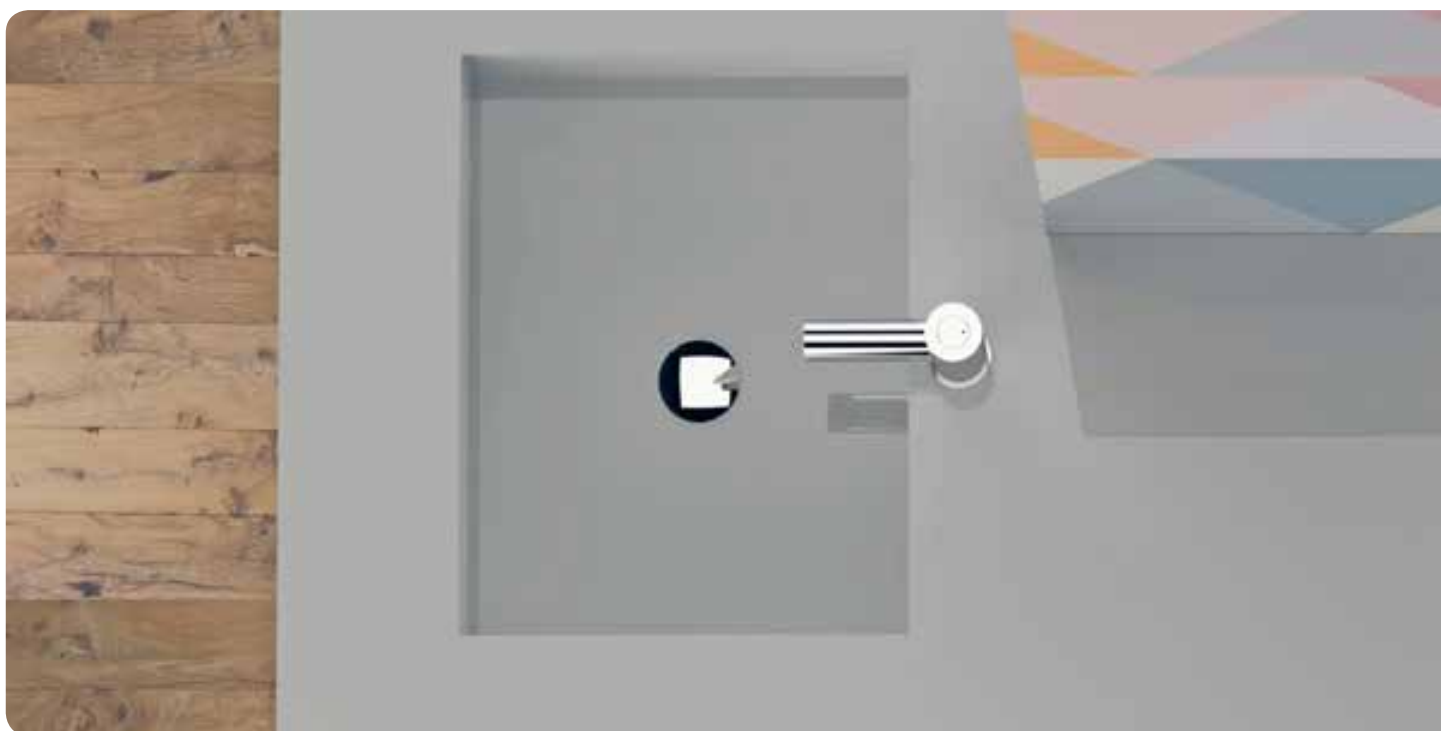



TTE19

Rubinetto a temporizzazione elettronica con attivazione tramite pulsante ad azionamento piezoelettrico alimentato a batteria, minimale quadrato, in ottone, tempo d'apertura circa 10 secondi, con rubinetto sottolavabo con filtro incluso.
Electronic timing pillar tap with piezoelectric activation button, batteries powered, minimal squared shape, all in brass, opening time about 10 seconds, angle valve with filter included.



TTE18

Rubinetto a temporizzazione elettronica con attivazione tramite pulsante ad azionamento piezoelettrico alimentato a batteria, minimale tondo, in ottone, tempo d'apertura circa 10 secondi, con rubinetto sottolavabo con filtro incluso.
Electronic timing pillar tap with piezoelectric activation button, batteries powered, minimal round shape, all in brass, opening time about 10 seconds, angle valve with filter included.



TTE219

Rubinetto a temporizzazione elettronica con attivazione tramite pulsante ad azionamento piezoelettrico alimentato a batteria, minimale quadrato, in ottone, a due tempi d'apertura: primo tempo circa 10 secondi, secondo tempo circa 20 secondi, con rubinetto sottolavabo con filtro incluso.
Electronic timing pillar tap with piezoelectric activation button, batteries powered, minimal squared shape, all in brass, two times opening: first time opening about 10 seconds, second time about 20 seconds, angle valve with filter included.



TTE218

Rubinetto a temporizzazione elettronica con attivazione tramite pulsante ad azionamento piezoelettrico alimentato a batteria, minimale tondo, in ottone, a due tempi d'apertura: primo tempo 10 secondi, secondo tempo 20 secondi, con rubinetto sottolavabo con filtro incluso.
Electronic timing pillar tap with piezoelectric activation button, batteries powered, minimal round shape, all in brass, two times opening: first time opening about 10 seconds, second time about 20 seconds, angle valve with filter included.

SENSOR

SENSOR COLOR

TEMPOR TOUCH

TEMPOR



TTE218

TEMPOR

TEMPOR



In ambienti pubblici la rubinetteria temporizzata rende un servizio importante in termini di risparmio idrico e razionalizzazione dell'uso dell'acqua.
 I rubinetti della serie Tempor sono articoli funzionali che si caratterizzano di design diversi per vestire adeguatamente ogni soluzione estetica, sia essa di design, moderna o più tradizionale.

*In public places the temporised timer mixers give an important service in terms of water saving and rationalisation of the use of water.
 Tempor taps are functional items that are characterised of different designs to meet properly every aesthetical solution, of design, modern or more traditional.*



SENSOR

SENSOR COLOR

TEMPOR TOUCH

TEMPOR

LAVABI - WASHBASIN MIXERS



TE15
 Rubinetto temporizzato a collo cigno, 1/2", in ottone, tempo d'apertura 6-8 secondi.
Temporized (timer) pillar tap, 1/2", all in brass, opening time 6-8 seconds.



TE16
 Rubinetto temporizzato a collo cigno, 1/2", in ottone, tempo d'apertura 6-8 secondi.
Temporized (timer) pillar tap, 1/2", all in brass, opening time 6-8 seconds.



TE18
 Rubinetto temporizzato a collo cigno, Minimal, 1/2", in ottone, tempo d'apertura 6-8 secondi.
Temporized (timer) pillar tap, 1/2", Minimal, all in brass, opening time 6-8 seconds.



TE18M
 Rubinetto miscelatore temporizzato a collo cigno con maniglia per la selezione dell'acqua calda/fredda, serie minimal, 1/2", in ottone, tempo di apertura 6-8 secondi.
Temporized (timer) mixer pillar tap with hot/cold water selection handle, serie minimal. 1/2", in brass, opening time 6-8 seconds.



TE19
 Rubinetto temporizzato serie SQ a collo cigno, 1/2", in ottone, tempo d'apertura 6-8 secondi.
Temporized (timer) pillar tap serie SQ, 1/2", all in brass, opening time 6-8 seconds.



TE225
 Rubinetto frontale temporizzato, 1/2", in ottone, tempo d'apertura 6-8 secondi.
Temporized (timer) frontal mounted 1/2" tap, all in brass, opening time 6-8 seconds.



TE53
 Rubinetto frontale temporizzato, con canna "S", 1/2", in ottone, tempo d'apertura 6-8 secondi.
Temporized (timer) frontal mounted, with "S" spout, 1/2" tap, all in brass, opening time 6-8 seconds.



TE41M
 Miscelatore a muro temporizzato per lavello con canna girevole.
Wall mounted temporized sink mixer, with movable spout.



TE42
 Rubinetto superiore temporizzato, con canna "J", 1/2", in ottone, tempo d'apertura 6-8 secondi.
Temporized (timer) upper mounted, with "J" spout, 1/2" tap, all in brass, opening time 6-8 seconds.



TEVI
 Cartuccia di ricambio per rubinetti temporizzati art. TE 15, TE 16, TE 53, TE 225, TE 855.
Spare cartridge for temporized (timer) taps art. TE 15, TE 16, TE 53, TE 225, TE 855.



TE42S
 Rubinetto superiore temporizzato, con canna "U", 1/2", in ottone, tempo d'apertura 6-8 secondi.
Temporized (timer) upper mounted, with "U" spout, 1/2" tap, all in brass, opening time 6-8 seconds.

TOILET



TE171
 Flussometro temporizzato a incasso, a pulsante, per wc, 3/4, 1", tempo d'apertura 6-8 secondi.
Temporized (timer) built-in tap for wc, 3/4, 1", opening time 6-8 seconds.



TE171Q
 Flussometro temporizzato a incasso quadrato a pulsante per wc, 3/4, 1", tempo d'apertura 6-8 secondi.
Temporized (timer) built-in squared tap for wc, 3/4, 1", opening time 6-8 seconds.



TE170 3/4 1"
 Flussometro temporizzato a pulsante esterno per WC, in ottone, tempo d'apertura 6-8 secondi, misure: 3/4, 1".
Temporized (timer) wall mounted tap, for wc, all in brass, opening time 6-8 seconds: 3/4, 1".



332TEL

Set composto da: doccia a pulsante, flessibile conico cm 120, rubinetto temporizzato 1/2" in ottone, tempo d'apertura 6-8 secondi.
Set composed of: shut-off handshower, flexible cm 120, temporized button flusher 1/2" all in brass, opening time 6-8 seconds.



TE855

Rubinetto temporizzato a pulsante per orinatoio, 1/2", in ottone, completo di rosoni, di due tubetti Ø mm 14 e guarnizione. Tempo d'apertura 6-8 secondi.
Temporized (timer) urinal button flusher, 1/2", in brass, in a set with flanges, two copper tubes Ø mm 14 and a washer. Opening time 6-8 seconds.



170TU

Ø 25

Ø 30

Tubo a "L" per flussometro esterno, in ottone, Ø 25, 30.
"L" brass pipe, for wall mounted tempor tap for wc, Ø 25, 30.



RB100TE

Set composto da: idroscopino a pulsante in ottone, flessibile conico cm 120, rubinetto temporizzato 1/2" in ottone, tempo d'apertura 6-8 secondi.
Set composed of: hydro brush in brass, flexible cm 120, temporized button flusher 1/2" all in brass, opening time 6-8 seconds.



TE856

Rubinetto temporizzato a pulsante per orinatoio, serie SQ, 1/2", in ottone, completo di rosoni, di due tubetti Ø mm 14 e guarnizione. Tempo d'apertura 6-8 secondi.
Temporized (timer) urinal button flusher serie SQ, 1/2" in brass, in a set with flanges, two copper tubes Ø mm 14 and a washer. Opening time 6-8 seconds.



856

Spartiacque per orinatoio, attacco Ø 15, con tubo Ø 15 mm.
Water divide for urinals, connection Ø 15, with pipe Ø 15 mm.

SENSOR

SENSOR COLOR

TEMPOR TOUCH

TEMPOR

DOCCIA - SHOWER MIXERS



351AVS

Soffione doccia antivandalo ed antimpiccagione con getto fisso.
Antivandal and antiligature shower head with fix spray.



TE31

Rubinetto temporizzato a pulsante per doccia esterno, 1/2"x1/2", in ottone, tempo d'apertura 18-20 secondi.
Temporized (timer) tap for shower, 1/2"x1/2", external, all in brass, opening time 18-20 seconds.



TE30M

Miscelatore doccia temporizzato da incasso.
Built-in temporized shower mixer.



TE32M

Miscelatore doccia temporizzato da incasso.
Built-in temporized shower mixer.



TE53329EX351

Rubinetto frontale temporizzato, colonna doccia 1/2" x 3/4" e soffione doccia standard, tempo d'apertura 6-8 secondi.
Temporized (timer) frontal mounted, with stand pipe 1/2" x 3/4" and standard shower head, opening time 6-8 seconds.



351AV

Soffione doccia antivandalo ed antimpiccagione con getto regolabile.
Antivandal and antiligature shower head with adjustable spray.



TE30

Rubinetto per doccia incasso temporizzato, 1/2", tempo d'apertura 18-20 secondi.
Temporized (timer) wall mounted tap, 1/2", opening time 18-20 seconds.



TE30Q

Rubinetto per doccia incasso temporizzato quadrato, 1/2", in ottone, tempo d'apertura 18-20 secondi.
Temporized (timer) wall mounted squared tap, 1/2", opening time 18-20 seconds.



TEVI30

Cartuccia di ricambio per rubinetti temporizzati art. TE 30 - TE 31.
Spare cartridge for temporized (timer) taps art. TE 30 - TE 31.

DESIGN

DESIGN MINIMALE - MINIMAL DESIGN

CONTRACT

CLASSICA - CLASSIC

TERMOSTATICI - THERMOSTATICS

SENSOR & TEMPOR

ACCESSORI - ACCESSORIES



COMPLEMENTI | *COMPLEMENTARY ITEMS*

pag. 276



RICAMBI | *SPARE PARTS*

pag. 290

COMPLEMENTI

COMPLEMENTARY ITEMS





SIFONI IN FINITURA - SIPHONS IN FINISH

CON OPZIONI DI FINITURA WITH FINISHING OPTIONS

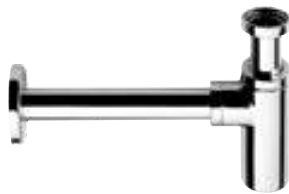

958L

Sifone "MINIMAL" in ottone, per lavabo, 1"1/4, canotto cm 30 e rosone pesante.
Brass "MINIMAL" P trap, for wash-basin, 1"1/4, outlet tube cm 30 and heavy flange.



958B

Sifone "MINIMAL" in ottone, per bidet, 1"1/4, canotto cm 30 e rosone pesante.
Brass "MINIMAL" P trap, for bidet, 1"1/4, outlet tube cm 30 and heavy flange.



960

Sifone SQ, in ottone, canotto cm 30, 1"1/4, con rosone pesante quadrato.
Brass SQ trap, 30 cm outlet tube, 1"1/4, with heavy squared wall flange.

FIN 1 NO BO NP NPO | FIN 2 CFP BG DO

SIFONI SALVASPAZIO - SAVE SPACING SIPHONS

CON OPZIONI DI FINITURA WITH FINISHING OPTIONS



985

Sifone salvaspazio con piletta click-clack incorporata con troppo pieno, rotondo, cromato.
Save-spacing siphon with click-clack built-in drain with overflow, round, chrome.



984

Sifone salvaspazio con piletta click-clack incorporata senza troppo pieno, rotondo, cromato.
Save-spacing siphon with click-clack built-in drain without overflow, round, chrome.



985S

Sifone salvaspazio con piletta click-clack incorporata con troppo pieno, quadrato, cromato.
Save-spacing siphon with click-clack built-in drain with overflow, squared, chrome.



984S

Sifone salvaspazio con piletta click-clack incorporata senza troppo pieno, quadrato, cromato.
Save-spacing siphon with click-clack built-in drain without overflow, squared, chrome.

FIN 1 NO BO NP NPO | FIN 2 CFP BG DO

SIFONI - TRAPS



977
Sifone a "P" in tubo, in ottone, 1" 1/4".
"P" trap made by tube, in brass, 1" 1/4".

1" 1/4



977X
Sifone "P" in tubo, in acciaio INOX, 1" 1/4".
"P" trap made by tube, in stainless steel, 1" 1/4".

1" 1/4



970
Sifone a bottiglia in ottone, canotto cm 25, 1", 1" 1/4".
Brass bottle trap, 25 cm outlet tube, 1", 1" 1/4".

1" 1" 1/2 1" 1/4



970Z
Sifone a bottiglia in zama senza pileta, per lavabo, 1" 1/4, canotto cm. 30.
Bottle trap in zamac without waste, for wash-basin, 1" 1/4, outlet tube cm 30.

1" 1/2 1" 1/4



971
Sifone a "S" in ottone, canotto cm 25, 1", 1" 1/4".
Brass "S" trap, 25 cm outlet tube, 1", 1" 1/4".

1" 1" 1/4



971Z
Sifone a "S" in zama, canotto cm 25, 1" 1/4".
"S" trap in zamac, 25 cm outlet tube, 1" 1/4".

1" 1/4



972
Sifone a "U" per lavabo a colonna in ottone, canotto cm 25, 1" 1/4".
Brass "U" trap, 25 cm outlet tube, 1" 1/4".

1" 1/4

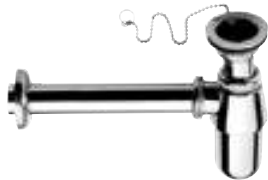

973Z
Sifone a bottiglia in zama con pileta, per lavabo, 1" 1/4".
Bottle trap in zamac with waste, for wash-basin, 1" 1/4".

1" 1/2 1" 1/4



956
Sifone fuso pesante lusso in ottone, per lavabo e bidet 1", 1" 1/4 canotto cm 30.
Brass luxury "P" trap, heavy type, 1", 1" 1/4, outlet tube cm 30.

1" 1" 1/4



98112
Sifone pesante in ottone fuso, con dado 1" 1/2 per colonna vasca.
Heavy trap in casting brass, with nut 1" 1/2 for bath waste and overflow.

1" 1/2



968
Ghiera per sifoni in ottone, 1" M x 1" 1/4 F, 1" 1/4 M x 1" 1/2 F.
Brass reduction for trap 1" Mx1" 1/4 F, 1" 1/4 Mx1" 1/2 F.

1" M x 1" 1/4 F 1" 1/4 M x 1" 1/2 F



969
Ghiera per sifoni in ottone, 1" 1/4 M x 1" F, 1" 1/2 M x 1" 1/4 F.
Brass reduction for trap 1" 1/4 Mx1" F, 1" 1/2 Mx1" 1/4 F.

1" 1/4 M x 1" F 1" 1/2 M x 1" 1/4 F

SCARICHI AUTOMATICI CLICK-CLACK - AUTOMATIC CLICK CLACK POP-UP WASTES

CON OPZIONI DI FINITURA  WITH FINISHING OPTIONS



904CC2
Scarico automatico con sistema click-clack, 1"1/4, e tappo grande, senza troppo pieno, modello con bicchiere corto.
Automatic pop-up waste, click-clack system, 1"1/4, big plug, without overflow, model with shorter cup.



904CC
Scarico automatico con sistema click-clack, 1"1/4, e tappo grande, senza troppo pieno.
Automatic pop-waste, click-clack system, 1"1/4, big plug, without overflow.



904SCC2
Scarico automatico quadrato 1"1/4 con click-clack senza troppo pieno, modello con bicchiere corto.
Squared automatic pop-up waste 1"1/4 with click-clack system without overflow, model with shorter cup.



904SCC
Scarico automatico quadrato 1"1/4 con click-clack senza troppo pieno.
Squared automatic pop-up waste 1"1/4 with click-clack system without overflow.



905CC2
Scarico automatico 1"1/4 con click-clack con troppo pieno, modello con bicchiere corto.
Automatic pop-up waste 1"1/4 with click-clack system with overflow, model with shorter cup.



905CC
Scarico automatico con sistema click-clack, 1"1/4, e tappo grande, con troppo pieno.
Automatic pop-up waste, 1"1/4, click-clack system, big plug, with overflow, model with shorter cup.



905SCC2
Scarico automatico quadrato 1"1/4 con click-clack con troppo pieno, modello con bicchiere corto.
Squared automatic pop-up waste 1"1/4 with click-clack system with overflow, model with shorter cup.



905SCC
Scarico automatico con sistema click-clack, 1"1/4, e tappo grande, con troppo pieno.
Squared automatic pop-up waste, click-clack system, 1"1/4, with overflow.



906CC2
Scarico automatico con sistema click-clack, 1"1/4, con troppo pieno, modello con bicchiere corto.
Automatic pop-up waste, click-clack system, 1"1/4, with overflow, model with shorter cup.



906CC
Scarico automatico con sistema click-clack, 1"1/4, con troppo pieno.
Automatic pop-up waste, 1"1/4, click-clack system, with overflow.



9072
Scarico automatico 1"1/4 con tappo grande sempre aperto e sistema click-clack per la pulizia interna, modello con bicchiere corto.
Automatic pop-up waste 1"1/4 with big plug always opened, and click-clack system for internal cleaning, model with shorter cup.



907
Scarico automatico 1"1/4 con tappo grande sempre aperto e sistema click-clack per la pulizia interna.
Automatic pop-up waste 1"1/4 with big plug always opened, and click-clack system for internal cleaning.

FIN 1



NO



BO



NP



NPO

FIN 2



CFP



BG



DO



905CCR
 Scarico automatico universale con chiusura click-clack da 1"1/4.
Universal automatic pop-up waste 1"1/4 with click-clack system.



905CCXL114
 Scarico automatico con sistema click-clack, 1" 1/4, tappo grande, con troppo pieno, versione extralunga.
Automatic pop-up waste, click-clack system, 1" 1/4, big plug, with overflow, extralong version.



RICAMBI
 COMPLEMENTARY ITEMS

RICAMBI
 SPARE PARTS

SCARICHI AUTOMATICI - POP-UP WASTES



95
 Scarico automatico 1", 1"1/4.
Brass pop-up waste, 1", 1"1/4.

1" 1" 1/4



95L80
 Scarico automatico da 1"1/4, tipo Lusso.
Brass pop-up waste 1"1/4, luxury type.

1" 1/4



95P80
 Scarico automatico in plastica da 1"1/4.
Plastic pop-up waste, 1"1/4.

1" 1/4



95Z
 Scarico automatico da 1"1/4, in zama.
Zamac 1"1/4 pop-up waste.

1" 1/4



95LS80
 Scarico automatico da 1"1/4, tipo lusso lucidato, con tappo grande quadrato piatto a copertura totale della piletta.
C.p. polished pop-up waste, 1"1/4, luxury type with big squared flat plug covering the drain.

1" 1/4



95LG80
 Scarico automatico da 1"1/4, tipo lusso lucidato, con tappo grande a copertura totale della piletta.
C.P. polished pop-up waste, 1"1/4, luxury type with big plug covering the drain.

1" 1/4



95AM
 Scarico tipo America o Americano, in ottone pulito e cromato.
C.p. waste model America or American, polished and in brass.

1" 1/4

RUBINETTI SOTTOLAVABO - ANGLE VALVES



117RA
Raccordo 3/8x10 con guarnizioni in 3 pezzi.
C.P. nut with 3 pcs washers 3/8x10.



117RA1210
Raccordo 1/2x10 con guarnizioni in 3 pezzi.
C.P. nut with 3 pcs washers 1/2x10.



1171238
Rubinetto sottolavabo con rosetta, 1/2x3/8.
Brass angle valve with flange, 1/2x3/8.



1171210
Rubinetto sottolavabo con calotta e rosetta, 1/2x10.
Brass angle valve with flange, 1/2x10.



1221210
Squadretta sottolavabo con snodo, attacco universale: 1/2, Ø 10 mm, con rosetta in ottone, 1/2x10.
Brass angle with ball-joint and flange, 1/2x10.



1241210
Curvetta sottolavabo, 1/2x10, con rosetta in ottone.
Brass elbow connection for wash basin, with flange, 1/2x10.



124S1210
Curvetta sottolavabo stampata, 1/2x10, con rosetta in ottone.
Brass forged elbow connection for wash basin, with flange, 1/2x10.



124R1210
Curvetta sottolavabo stampata, 1/2x10, allungabile, con rosetta in ottone.
Brass forged elbow connection for wash basin, extendible, with flange, 1/2x10.



120SN1210
Rubinetto sottolavabo a vitone, con filtro e snodo, 1/2x10, con rosetta in ottone.
Brass angle valve with filter, balljoint and brass flange, 1/2x10.



121T
Rubinetto combinato 1/2" sottolavabo e 3/4" attacco lavatrice, 1/2x3/4x10.
Brass union valve 1/2", with undersink coupling and 3/4" connection for washing machine, 1/2x3/4x10.



118 Ø 12
11814 Ø 14
Squadretta sottolavabo Ø 12mm o 14mm x 15x25cm, con nipples e dado 1/2.
Brass square angle connection Ø 12mm or 14mm x 15x25cm, with nipples and nut 1/2.



1231210
Rubinetto sottolavabo con filtro e calotta, 1/2x10, con rosetta in ottone.
Brass angle valve with filter and flange, 1/2x10.

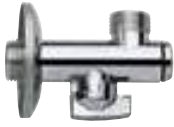

1231212

Rubinetto sottolavabo con filtro, 1/2x1/2, con rosetta in ottone.
Brass angle valve with filter and flange, 1/2x1/2.

1231234

Rubinetto sottolavabo con filtro, 1/2x3/4, con rosetta in ottone.
Brass angle valve with filter and flange, 1/2x3/4.

1231238

Rubinetto sottolavabo con filtro, 1/2x3/8, con rosetta in ottone.
Brass angle valve with filter and flange, 1/2x3/8.

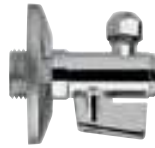

127A1210

Rubinetto sottolavabo con filtro, calotta, 1/2x10 e rosetta in ottone.
Brass angle valve with filter and flange, 1/2x10.

127A1212

Rubinetto sottolavabo con filtro, 1/2x1/2, con rosetta in ottone.
Brass angle valve with filter and flange, 1/2x1/2.

127A1238

Rubinetto sottolavabo con filtro, 1/2x3/8, con rosetta in ottone.
Brass angle valve with filter and flange, 1/2x3/8.



1291212

Rubinetto sottolavabo 1/2x1/2 con rosetta.
Brass angle valve for wash basin 1/2x1/2 with flange.

1291238

Rubinetto sottolavabo 1/2x3/8 con rosetta.
Brass angle valve for wash basin 1/2x3/8 with flange.

1291210

Rubinetto sottolavabo 1/2x10 con rosetta.
Brass angle valve for wash basin 1/2x10 with flange.



123SN1210

Rubinetto sottolavabo con filtro e snodo, 1/2x10, con rosetta in ottone.
Brass angle valve with filter, ball joint and flange, 1/2x10.



128R1212

Rubinetto a sfera con guarnizione in PTFE e rosetta, 1/2x1/2.
Brass ball valve with PTFE washer and flange, 1/2x1/2.

128R1238

Rubinetto a sfera con guarnizione in PTFE e rosetta, 1/2x3/8.
Brass ball valve with PTFE washer and flange, 1/2x3/8.



128E1238

Rubinetto sottolavabo "Esagonale", con vitone ceramico, 1/2x3/8.
Brass "Hexagonal" angle valve, with ceramic head valve, 1/2x3/8.

128E1210

Rubinetto sottolavabo "Esagonale", con dado e guarnizione art. 117 RA, con vitone ceramico, 1/2x10.
Brass "Hexagonal" angle valve, with nut and washers art. 117 RA, with ceramic head valve, 1/2x10.

128E1212

Rubinetto sottolavabo "Esagonale", con vitone ceramico, 1/2x1/2.
Brass "Hexagonal" angle valve, with ceramic head valve, 1/2x1/2.



128R1210

Rubinetto a sfera con guarnizione in PTFE, con calotta e rosetta in ottone, 1/2x10.
Brass ball valve with PTFE washer and flange, 1/2x10.

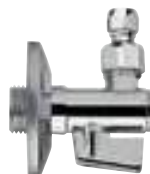

127ASN1210

Rubinetto sottolavabo con filtro e snodo, 1/2x10, con rosetta in ottone.
Brass angle valve with filter, ball joint and flange, 1/2x10.

CON OPZIONI DI FINITURA  WITH FINISHING OPTIONS



128L1212

Rubinetto sottolavabo "MINIMAL", con vitone ceramico, con maniglia a leva, 1/2x1/2.
Brass "MINIMAL" angle valve, with ceramic headvalve, with lever handle, 1/2x1/2.

1/2x1/2



128S1212

Rubinetto sottolavabo quadrato, con vitone ceramico, 1/2x1/2.
Brass squared angle valve, with ceramic head valve, 1/2x1/2.

1/2x1/2

FIN 1



NO



BO



NP



NPO

FIN 2



CFP



BG



DO



128L1238

Rubinetto sottolavabo "MINIMAL", con vitone ceramico, con maniglia a leva, 1/2x3/8.
Brass "MINIMAL" angle valve, with ceramic headvalve, with lever handle, 1/2x3/8.

1/2x3/8



128S1238

Rubinetto sottolavabo quadrato, con vitone ceramico, 1/2x3/8.
Brass squared angle valve, with ceramic head valve, 1/2x3/8.

1/2x3/8

128L1210

Rubinetto sottolavabo "MINIMAL", con vitone ceramico, con maniglia a leva, dado e guarnizione art. 117 RA, 1/2x10.
Brass "MINIMAL" angle valve, with ceramic headvalve, with lever handle, nut and washers art. 117 RA, 1/2x10.

1/2x10

128S1210

Rubinetto sottolavabo quadrato, con dado e guarnizione art. 117 RA, con vitone ceramico, 1/2x10.
Brass squared angle valve, with nut and washers art. 117 RA, with ceramic head valve, 1/2x10.

1/2x10

RUBINETTI - MIXERS



61

Rubinetto prolungato con comando a gomito, 1/2.
Wall mounted long tap, 1/2, with long lever.



63

Rubinetto a snodo con comando a gomito, 1/2, con canna inferiore.
Wall mounted hose-holder tap, 1/2, with long lever and S inferior spout.



64

Gruppo lavello con comando a gomito e canna inferiore.
Wall mounted mixer, with long levers and S inferior spout.



14LL

Gruppo lavello tipo a ponte con comando a gomito e canna Ø 18 mm.
Sink mixer bridge type, with long lever and spout Ø 18 mm.



65

Rubinetto collo cigno con comando a gomito, 1/2.
Wash basin pillar tap, 1/2, with long lever.

61LE

Leva in ottone per articoli 61, 63, 64, 65, 14LL.
Lever for art. 61, 63, 64, 65, 14LL.





MA14
Leva lunga per miscelatori con cartuccia Ø 40.
Spare long lever for single lever mixers with Ø 40 cartridge.



61VI
Vitone da 1/2 per articoli 61, 63, 64, 65, 14LL.
Head valve 1/2 for articles 61, 63, 64, 65, 14LL.



66
Rubinetto a pedale ad incasso in ottone.
Built in tap foot operated, in brass.



66MP
Rubinetto-miscelatore pedaliera universale. Può essere installato sia a parete che a pavimento.
Treadle mixer with universal pedal control. It can be installed both on the wall and on the floor.



67
Bocca a snodo per lavello.
Swivel spout for washbasin.



67N
Bocca alta minimale.
Minimal high spout.



67Q
Bocca alta quadrata.
Squared high spout.



69
Rubinetto a pulsante a zampillo parabolico per refrigeratore o depuratore. Regolazione del getto sotto il pulsante.
Parabolic jet button tap for refrigerator or purifier. Water flow control under the button.

CON OPZIONI DI FINITURA  WITH FINISHING OPTIONS



31N
Rubinetto d'arresto minimale 1/2".
1/2" minimal angle valve.



31N34
Rubinetto d'arresto minimale 3/4".
3/4" minimal angle valve.



31W
Rubinetto doccia incasso 1/2".
Built-in right valve 1/2".

FIN 1



NO



BO



NP



NPO

FIN 2



CFP



BG



DO

COLONNE PER BORDO VASCA - VERTICAL CONNECTIONS FOR BATH MIXER



8801LI
Coppia colonne vasca in ottone, serie Liberty, 3/4M x 3/4M.
Couple brass vertical connections for bath mixer, serie Liberty, 3/4M x 3/4M.



8801LIS
Coppia colonne vasca in ottone, serie Liberty, con supporto doccia, 3/4M x 3/4M.
Couple brass vertical connections for bath mixer, serie Liberty, with handshower holder 3/4M x 3/4M.



88N02
Coppia colonne vasca in ottone, serie Minimal, con supporto doccia, 3/4M x 3/4M.
Couple brass vertical connections for bath mixer, serie Minimal, with handshower holder 3/4M x 3/4M.



88UK
Coppia colonnette bordo vasca in ottone, serie UK, 3/4Mx3/4M.
Couple brass vertical connections for bath mixer, serie UK, 3/4M x 3/4M.



88LI
Coppia colonnette bordo vasca in ottone, serie Liberty, 3/4M x 3/4M.
Couple brass vertical connections for bath mixer, serie Liberty, 3/4M x 3/4M.



88
Colonnetta per bordo vasca in ottone, 1/2M x 3/4M.
Brass vertical connection for bath mixer, 1/2M x 3/4M.



88BI
Colonnetta per bordo vasca, verniciata bianca, 1/2M x 3/4M.
Vertical connection for bath mixer in white colour, 1/2M x 3/4M.

DEVIATORI - DIVERTERS



Q93DEV3
Deviatore a tre vie (una entrata e tre uscite) su piastra, serie Qubika.
Three ways diverter (1 inlet and 3 outlets) on flange, Qubika serie.



Q93DEV7
Deviatore a tre vie e sette posizioni (una entrata, tre uscite e sette posizioni con cui selezionare uscite singole o miscelate tra loro) su piastra, serie Qubika.
Three ways diverter with seven positions (1 inlet and 3 outlets and seven positions to select single or mixed outlets) on flange, Qubika serie.



N93DEV3
Deviatore a tre vie (una entrata e tre uscite) su piastra, serie Minimal.
Three ways diverter (1 inlet and 3 outlets) on flange, Minimal serie.



N93DEV7
Deviatore a tre vie e sette posizioni (una entrata, tre uscite e sette posizioni con cui selezionare uscite singole o miscelate tra loro) su piastra, serie Minimal.
Three ways diverter with seven positions (1 inlet and 3 outlets and seven positions to select single or mixed outlets) on flange, Minimal serie.



COPERTURA A PAVIMENTO IN ACCIAIO INOX - STAINLESS STEEL FLOOR DRAINS

cm 10 x 10

**913GVC10**

Copertura a pavimento in acciaio inox cm 10x10, con griglia fissa e coperchio mobile.

Stainless steel floor drain cm 10x10, with fixed grill and swivel plug.

**913GV10**

Copertura a pavimento in acciaio inox cm 10x10, con griglia fissa.

Stainless steel floor drain cm 10x10, with fixed grill.

**913GVC15**

Copertura a pavimento in acciaio inox cm 15x15, con griglia fissa e coperchio mobile.

Stainless steel floor drain cm 15x15, with fixed grill and swivel plug.

**913GV15**

Copertura a pavimento in acciaio inox cm 15x15, con griglia fissa.

Stainless steel floor drain cm 15x15, with fixed grill.

**913CV15**

Copertura a pavimento in acciaio inox cm 15x15, con coperchio avvitato fisso.

Stainless steel floor drain cm 15x15, with fixed plug.

**913GFC15**

Copertura a pavimento in acciaio inox cm 15x15, con griglia e coperchio mobili.

Stainless steel floor drain cm 15x15, with swivel grill and swivel plug.

cm 15 x 15

cm 20 x 20

**913GVC20**

Copertura a pavimento in acciaio inox cm 20x20, con griglia fissa e coperchio mobile.

Stainless steel floor drain cm 20x20, with fixed grill and swivel plug.

**913GV20**

Copertura a pavimento in acciaio inox cm 20x20, con griglia fissa.

Stainless steel floor drain cm 20x20, with fixed grill.

**913CV20**

Copertura a pavimento in acciaio inox cm 20x20, con coperchio avvitato fisso.

Stainless steel floor drain cm 20x20, with fixed plug.

**913GFC20**

Copertura a pavimento in acciaio inox cm 20x20, con griglia e coperchio mobili.

Stainless steel floor drain cm 20x20, with swivel grill and swivel plug.

SIFONI ANTI SCARAFAGGIO - ANTI COCKROACH-INSECTS TRAPS



913PSA01

Sifone anti-scarafaggio da utilizzare per coperture a pavimento cm 15x15 e 20x20.
Anti cockroach-insects to use under the floor drains with size cm 15x15 e 20x20.



913PSA02

Sifone anti-scarafaggio da utilizzare per coperture a pavimento cm 10x10.
Anti cockroach-insects to use under the floor drains with size cm 10x10.

CANALINE SIFONATE RETTANGOLARI - RECTANGULAR FLOOR DRAINS



913RG12

Canalina sifonata a pavimento, in acciaio inox, con griglia di drenaggio, larghezza 12,5 cm lunghezze cm 70, 80, 90, 100, 120.
Rectangular floor drain, in stainless steel, with drain grill, large 12,5 cm, lengths cm 70, 80, 90, 100, 120.

70 80 90 100 120



913RP12

Canalina sifonata a pavimento, in acciaio inox, piastrellabile, larghezza 12,5 cm lunghezze cm 70, 80, 90, 100, 120.
Rectangular floor drain, in stainless steel, model for tiling, large 12,5 cm, lengths cm 70, 80, 90, 100, 120.

70 80 90 100 120

PILETTE DA PAVIMENTO SIFONATE - STAINLESS STEEL FLOOR DRAINS AND SIPHONS



913SF10

Piletta da pavimento sifonata in acciaio inox, cm 10x10.
Stainless steel floor drain and siphon, cm 10x10.



913SF15

Piletta da pavimento sifonata in acciaio inox, cm 15x15.
Stainless steel floor drain and siphon, cm 15x15.



913SF20

Piletta da pavimento sifonata in acciaio inox, cm 20x20.
Stainless steel floor drain and siphon, cm 20x20.

COLONNE DI SCARICO BATH WASTES



96P
 Colonna di scarico automatica in plastica con filo esterno, senza dado e codulo.
Plastic combined bath waste with automatic pop-up with external wire.



96PCC
 Colonna di scarico in plastica, con piletta "click-clack".
Plastic combined bath waste and overflow, "click-clack" waste system.



96LICC
 Colonna di scarico con sifone per vasca con tubo in rame cromato e piletta click-clack, tutta cromata.
Bath brass waste with siphon, trap, chromated copper tube and click clack waste, all in chrome plated.



96LIT
 Colonna di scarico con sifone per vasca con tubo in rame cromato, tutta cromata.
Bath brass waste with siphon, trap and chromated copper tube, all in chrome plated.



96
 Colonna di scarico automatica con filo esterno e tubo in rame senza dado e codulo.
Brass automatic bath waste and overflow with external wire and copper tube.



96CC
 Colonna di scarico con tubo in rame, con piletta "click-clack".
Brass waste and overflow with copper tube and "click-clack" waste.



96VA
 Colonna di scarico automatico con filo esterno e tubo in rame cm 70, per vasca ad angolo.
Brass automatic bath waste, overflow and copper tube, cm 70, for bath tube edge.

RICAMBI *SPARE PARTS*





CARTUCCE IN BLISTER CARTRIDGES IN BLISTER



S50Y
 Cartuccia Ø mm 40 a dischi in ceramica per vasca, lavabo, bidet (tipo con distributori).
Ceramic cartridge Ø 40 mm for bath, wash basin, bidet (type with distributor).



S52Y
 Cartuccia Ø mm 40 a dischi in ceramica per lavello, doccia (tipo piatto).
Ceramic cartridge Ø 40 mm for sink and shower (flat bottom type).



R50Y
 Cartuccia Ø mm 35 a dischi in ceramica per vasca, lavabo, bidet (tipo con distributori).
Ceramic cartridge Ø 35 mm for bath, wash basin, bidet (type with distributor).



R52Y
 Cartuccia Ø mm 35 a dischi in ceramica per lavello, doccia (tipo piatto).
Ceramic cartridge Ø 35 mm for sink and shower (flat bottom type).



W50Y
 Cartuccia Ø mm 35 a dischi ceramica per lavello, doccia, vasca, bidet (tipo piatto).
Ceramic cartridge Ø 35 mm for sink, shower, bath, bidet (flat bottom type).

CARTUCCE - CARTRIDGES



S50AF
 Cartuccia ad apertura forzata Ø mm 40 a dischi ceramici per vasca, lavabo, bidet (tipo con distributori) permette un notevole risparmio idrico.
Forced opening ceramic cartridge Ø 40 mm for bath, wash basin, bidet (type with distributors) permit a remarkable saving of water.



S52AF
 Cartuccia ad apertura forzata Ø mm 40 a dischi ceramici per lavello, doccia (tipo piatto) permette un notevole risparmio idrico.
Forced opening ceramic cartridge Ø 40 mm for sink, shower (flat bottom type) permit a remarkable saving of water.



R50AF
 Cartuccia ad apertura forzata Ø 35 mm a dischi ceramici per lavello, doccia (tipo con distributori) permette un notevole risparmio idrico.
Forced opening ceramic cartridge Ø 35 mm for sink, shower (type with distributors) permit a remarkable saving of water.



R52AF
 Cartuccia ad apertura forzata Ø 35 mm a dischi ceramici per lavello, doccia (tipo piatto) permette un notevole risparmio idrico.
Forced opening ceramic cartridge Ø 35 mm for sink, shower (flat bottom type) permit a remarkable saving of water.



P50
 Cartuccia progressiva Ø 35 mm, con distributori, con chiusura del flusso e uscita dell'acqua verso il basso.
Ceramic cartridge Ø 35 mm, with distributors, with flow shut-off and water outlet towards the low.



P52
 Cartuccia progressiva Ø 35 mm, senza distributori, con chiusura del flusso e uscita dell'acqua verso il basso.
Ceramic cartridge Ø 35 mm, without distributors, with flow shut-off and water outlet towards the low.



V50C
 Cartuccia a dischi ceramici Ø 25 mm, tipo piatto.
Ceramic cartridge Ø 25 mm, flat bottom type



V50A
 Cartuccia a dischi ceramici Ø 25, con uscita dell'acqua direttamente dalla parte alta dell'involucro a cilindro senza quindi essere riconvolgiato verso il fondo della cartuccia.
Ceramic discs cartridge Ø 25, with water outlet directly from the top part of the cylindric shell without being joined towards the bottom of the cartridge.



J50
Cartuccia a dischi ceramici Ø mm 35, movimento a "joystick", tipo piatto.
Ceramic cartridge Ø 35 mm, "joystick" movement, flat bottom type



E50C
Cartuccia termostatica coassiale serie MINIMAL THERMO e QUBIKA THERMO.
Thermostatic coaxial cartridge serie MINIMAL THERMO and QUBIKA THERMO.



E50P
Cartuccia termostatica con rotazione manopola a 330° angolari, blocco di sicurezza a 38°C, campo di lavoro da 5°C a 80°C, campo di pressione da 1 a 10 bar, filtro inox e sistema di sicurezza con blocco dell'erogazione in caso di mancanza di una delle due acque, realizzato con materiali termoplastici ad elevata robustezza.
Thermostatic cartridge with 330° angular handle rotation, 38° safety lock, working field from 5°C to 80°C, pressure field from 1 to 10 bar, stainless steel filter and safety system with the outlet lock in case there is one water lock, high performance thermoplastic materials.

PROLUNGHE - EXTENSIONS



K09PROL
Prolunga per corpo monocomando doccia incasso con deviatore per cartuccia Ø 40 mm.
Extension for built-in shower mixer body with diverter for cartridge Ø 40 mm.



N09PROL
Prolunga per corpo monocomando doccia incasso con deviatore per cartuccia Ø 35 mm.
Extension for built-in shower mixer body with diverter for cartridge Ø 35 mm.



S52PROL
Prolunga per corpo monocomando doccia incasso per cartuccia Ø 40 mm.
Extension for built-in shower mixer body for cartridge Ø 40 mm.



R52PROL
Prolunga per corpo monocomando doccia incasso per cartuccia Ø 35 mm.
Extension for built-in shower mixer body for cartridge Ø 35 mm.



X15PROL
Prolunga per lavabo incasso. Anche in versione "Box Incasso".
Extension for built-in basin mixer. Also available in "Built-in Box" version.

Adatto per - Suitable for :
X 15



N15PROL
Prolunga per lavabo incasso. Anche in versione "Box Incasso".
Extension for built-in basin mixer. Also available in "Built-in Box" version.

Adatto per - Suitable for :
N 15 - S15



Q15PROL
Prolunga per lavabo incasso. Anche in versione "Box Incasso".
Extension for built-in basin mixer. Also available in "Built-in Box" version.

Adatto per - Suitable for :
W 15 - EY15 - I15 - D15 - L15 - Q15



V15PROL
Prolunga per lavabo incasso. Anche in versione "Box Incasso".
Extension for built-in basin mixer. Also available in "Built-in Box" version.

Adatto per - Suitable for :
V15 - AU15

DEVIATORI AUTOMATICI - AUTOMATIC DIVERTERS



DEV00
Deviatore in ottone automatico con molla e fermo per basse pressioni.
Automatic brass diverter with spring and lock for low pressure.



DEV08
Deviatore in ottone automatico con molla e fermo, con prolunga 8 mm.
Automatic brass diverter with spring and lock, mm 8 extended in 1/2 side.



DEV13
Deviatore in ottone automatico con molla e fermo, con prolunga 13 mm.
Automatic brass diverter with spring and lock, mm 13 extended in 1/2 side.

VITONI - HEADVALVES



75
Vitone universale per rubinetti, che permette di ottenere 102 combinazioni di misure e lunghezze. Confezione skin-pack.
Universal headvalve for taps, allow to create 102 different combinations of lengths and sizes. Packed in a safe skin-pack.



7719
Vitone con filetto 19/19, per rubinetti incasso.
19/19 Head valve thread, for built-in stop cocks.



74
Vitone da 1/2 per gruppo vasca, lavello, batteria lavabo, rubinetto bidet e incasso per art. 53, 55.
Head valve 1/2" for bath, sink, wash basin, bidet and built-in stop cock for art. 53, 55.



74E
Come 74, tipo leggero.
As 74, light type.



74F
Vitone da 1/2 con filetto per coprivitone M24x1.
Head valve 1/2 with thread M24x1 for head valve cover.



7718
Vitone filetto 18/19 per art. 221, 223, 224, 250, 252 e altri.
18/19 Head valve thread for art. 221, 223, 224, 250, 252 and others.



7738
Vitone con filetto 3/8, per rubinetti.
3/8 Head valve thread, for taps.



76DX180
Vitone 180° a dischi ceramici, broccia Ø mm 8, 20 denti, destro.
Head valve 180° ceramic discs, broach Ø 8 mm, 20 teeth, right.



76DX24
Vitone 90° a dischi ceramici, broccia Ø 8 mm, 24 denti, destro.
Head valve 90° ceramic discs, broach Ø 8 mm, 24 teeth, right.



76DX
Vitone 90° a dischi ceramici, broccia Ø 8 mm, 20 denti, destro.
Head valve 90° ceramic discs, broach Ø 8 mm, 20 teeth, right.



76SX180
Vitone 180° a dischi ceramici, broccia Ø mm 8, 20 denti, sinistro.
Head valve 180° ceramic discs, broach Ø 8 mm, 20 teeth, left.



76SX24
Vitone 90° a dischi ceramici, broccia Ø 8 mm, 24 denti, sinistro.
Head valve 90° ceramic discs, broach Ø 8 mm, 24 teeth, left.



76SX
Vitone 90° a dischi ceramici, broccia Ø 8 mm, 20 denti, sinistro.
Head valve 90° ceramic discs, broach Ø 8 mm, 20 teeth, left.



78
Vite fissa maniglia.
Screw for fixing handle.

AERATORI - AERATORS

**81A**

Aeratore anticalcare ad alta tecnologia F22, brevettato e di lunghissima durata, scocca in ottone ed interno in materiale plastico innovativo a forte resistenza.

High technology antilimestone aerator F22, patented and long-lasting, shell in brass, internal in innovative plastic material very resistant.

**83A**

Aeratore anticalcare ad alta tecnologia M24, brevettato e di lunghissima durata, scocca in ottone ed interno in materiale plastico innovativo a forte resistenza.

High technology antilimestone aerator M24, patented and long-lasting, shell in brass, internal in innovative plastic material very resistant.

**83C**

Chiave brevettata per la pulizia settimanale degli aeratori ad alta tecnologia art 81 A e art 83 A.

Patented key for the weekly cleaning of the high technology aerators art 81 A and 83 A.

**81**

Aeratore classico con retine in inox, per gruppo lavello F22.

Classic aerator with inox nets, for sink spout F22.

**83**

Aeratore classico con retine in inox, per lavabo, lavello e bidet M24.

Classic aerator with inox nets, for basin, bidet and sink, M24.

**84A**

Aeratore per gruppo vasca, M28.

Aerator for bath mixer, M28.

**83F16**

Aeratore F16.

F16 aerator.

**81SN**

Snodo attacco F22 con ghiera M22.

Joint F22 and nut M22.

**83SN**

Snodo attacco M22 con ghiera M24.

Joint M22 and nut M24.

**83N41**

Aeratore M18.

M18 aerator.

**85**

Aeratore con snodo per monoforo bidet, M24.

Balljoint aerator for one-hole bidet, M24.

**83NESI**

Aeratore Neoperl autopulente M24X1 con erogatore in silicone morbido anticalcare per una pulizia manuale semplificata.

Neoperl aerator selfcleaning M24X1 with silicon antilimestone bottom, for soft simplified handcleaning.

**83NE**

Aeratore Neoperl effetto a scomparsa, con filetto M24X1 che puo' essere sostituito senza difficoltà a tutte le rubinetterie con filettatura per aeratore M24X1. Molto indicato per modelli di design quali Qubika, Minimal, SQ.

Neoperl aerator with built-in effect, M24X1 thread, can be easily substituted to all the standard mixers with M24X1 aerators. Very indicated for design models like Qubika, Minimal, SQ.

**83NEBA**

Aeratore Neoperl M24X1 con getto direzionabile tramite terminale basculante, permette con il semplice tocco della parte inferiore dell'aeratore di dirigere il flusso della direzione desiderata.

Neoperl aerator M24X1 with swivel aerator bottom that, with the simple touch, permits to move the flow to the preferred direction.

**83EU**

Aeratore Neoperl M24 coin slot. Installazione e rimozione dell'aeratore utilizzando una moneta inserita nell'apposita fessura.

Neoperl aerator M24 coin slot. Installation and removal of the aerator by using a coin placed in the slot.

**83Z40**

Aeratore M24 ultrapiatto, utilizzabile su ogni lavabo o lavello. Installazione e rimozione con chiave 83 Z40 C.

Ultra-flat aerator M24, suitable on every wash-basin or sink. Installation and removal with key 83 Z40 C.

**83Z40C**

Chiave brevettata per la pulizia settimanale degli aeratori ad alta tecnologia art 83 Z40.

Patented key for the weekly cleaning of the high technology aerators art 83 Z40.



AERATORI: LINEA RISPARMIO IDRICO-ENERGICO E ANTIVANDALICO
AERATORS: WATER ENERGY SAVING LINE AND ANTI-VANDALISM



83AVC

Kit antivandalico e anticalcare composto da aeratore speciale per miscelatori lavabo e bidet M24 e chiave di montaggio, manutenzione e pulizia settimanale, ad alta tecnologia, brevettata. *Anti-vandalism and antilimestone kit, composed of special aerator for wash basin and bidet mixers M24 and assembly, caring and weekly cleaning key, high technology and patented.*



83SETL6 83SETL8

Set risparmio idrico totale composto da raccordo doccia 1/2" in ottone a portata limitata, aeratore lavabo e bidet M24 a portata limitata e chiave di montaggio manutenzione e pulizia settimanale, ad alta tecnologia, brevettata. Il kit è disponibile in varianti da 6 litri al minuto (cod 83 SET L6) o 8 litri al minuto (cod 83 SET L8). *Total water saving set, composed of 1/2" shower connection with reduced flow in brass, wash basin and bidet aerator with reduced flow and assembly, caring and weekly cleaning key, high technology, patented. This set is available with outlet flow of 6 liters by minute (cod 83 SET L6) or 8 liters by minute (cod 83 SET L8).*

83SETL6

83SETL8



83AVCL6 83AVCL8

Kit come 83 AVC, più risparmio idrico, che include anche limitatore di portata da 6 litri al minuto, art 83AVC L6, o limitatore di portata da 8 litri al minuto, art 83AVC L8. *Kit same as 83 AVC, plus water saving, that also includes one reduction of water consumption at 6 liters by minute, art 83 AVC L6, or one reduction of water consumption at 8 liters by minute, art 83 AVC L8.*

83AVCL6

83AVCL8



83L6 83L8

Aeratore lavabo e bidet M24, per risparmio idrico con limitatore di portata da 6 litri al minuto (art. 83 L6) o da 8 litri al minuto (art. 83 L8). *Aerator for wash basin and bidet mixers, M24, water saving, with reduction of consumption and excellent flow at 6 litres by minute (art. 83 L6) or 8 liters by minute (art. 83 L8).*

83L6

83L8



309RL6 309RL8

Raccordo doccia 1/2" a risparmio idrico con limitatore di portata da 6 litri al minuto (art 309 L6) o 8 litri al minuto (art 309 L8). *Brass connection, water saving program with flow reduction at 6 liters by minute (art 309 L6) or 8 liters by minute (art 309 L8).*

309RL6

309RL8



662FI12

Guarnizione da 1/2" con filtro retinato anti-impurità. *1/2" washer with net filter, anti-impurity.*



662RE12

Guarnizione da 1/2" a passaggio ridotto, con risparmio idrico del 30%. *1/2" washer, reduced flow, water saving 30%.*

KIT PULIZIA AERATORE
CLEANING KIT WITH AERATOR



83SET01

Set completo di 3 aeratori anticalcare M24 ad alta tecnologia + 1 chiave per la pulizia settimanale, brevettati e di lunghissima durata, il tutto in ottone e materiale plastico innovativo a forte resistenza, confezionato in un tubo contenitore rigido e trasparente adatto per essere appeso. La chiave è stata studiata per pulire il calcare dall'aeratore in un solo semplice movimento. *Set complete of 3 antilimestone M24 aerators of high technology + 1 weekly cleaning key, patented and extremely long lasting, all in brass and innovative plastic material very resistant, packed in a holding hard and transparent tube, suitable to be hung. The key has been studied to clean the aerator in one simple, easy movement.*



83SET02

Set completo di 2 aeratori anticalcare M24 ad alta tecnologia ed e 1 aeratore anticalcare F22 + 1 chiave per la pulizia settimanale, brevettati e di lunghissima durata, il tutto in ottone e materiale plastico innovativo a forte resistenza, confezionato in un tubo contenitore rigido e trasparente adatto per essere appeso. La chiave è stata studiata per pulire il calcare dall'aeratore in un solo semplice movimento. *Set complete of 2 antilimestone M24 aerators of high technology and 1 antilimestone F22 aerator + 1 weekly cleaning key, patented and extremely long lasting, all in brass and innovative plastic material very resistant, packed in a holding hard and transparent tube, suitable to be hung. The key has been studied to clean the aerator in one simple, easy movement.*



81 AC

Set completo di 1 aeratore F22 anticalcare ad alta tecnologia + 1 chiave di pulizia settimanale, brevettati e di lunghissima durata, il tutto in ottone e materiale plastico innovativo a forte resistenza. L'aeratore e la chiave sono stati studiati per pulire il calcare dall'aeratore in un solo semplice movimento.
Set complete of 1 antilimestone F22 aerator of high technology + 1 weekly cleaning key, patented and extremely long lasting, all in brass and innovative plastic material very resistant. The aerator and the key has been studied to clean the aerator in one simple, easy movement.

83 AC

Set completo di 1 aeratore M24 anticalcare ad alta tecnologia + 1 chiave di pulizia settimanale, brevettati e di lunghissima durata, il tutto in ottone e materiale plastico innovativo a forte resistenza. L'aeratore e la chiave sono stati studiati per pulire il calcare dall'aeratore in un solo semplice movimento.
Set complete of 1 antilimestone M24 aerator of high technology + 1 weekly cleaning key, patented and extremely long lasting, all in brass and innovative plastic material very resistant. The aerator and the key has been studied to clean the aerator in one simple, easy movement.

RIDUZIONI - REDUCTIONS



81RD12

Riduzione 1/2MxM22. Consente di collegare qualsiasi attacco da 1/2F", esempio tutti i flessibili doccia, con un aeratore standard lavabo/lavello F22, vedi ns articolo 81A (al posto di una doccia o di uno shut off).
Reduction 1/2MxM22. Allows to connect any 1/2F" connection, for example all the shower flexibles, with a standard aerator basin/sink F22, see our art. 81A (instead of the classic handshower or shut-off).



81RD12M22F

Riduzione 1/2MxF22. Consente di collegare al lavabo/lavello F22 un qualsiasi componente con attacco 1/2F.
1/2MxF22 reduction. Connecting any component with 1/2F connection to the washbasin/sink F22.



83RD12F22F

Riduzione 1/2FxM22. Consente di collegare al lavabo/lavello F22 un qualsiasi componente con attacco 1/2M.
1/2FxM22 reduction. Connecting any component with 1/2M connection to the washbasin/sink F22.



83RD12

Riduzione 1/2MxF24. Consente di collegare qualsiasi attacco da 1/2F", esempio tutti i flessibili doccia, con un aeratore standard lavabo M24, vedi ns articolo 83A (al posto di una doccia o di uno shut off).
Reduction 1/2MxF24. Allows to connect any 1/2F" connection, for example all the shower flexibles, with a standard aerator basin M24, see our art. 83A (instead of the classic handshower or shut-off).



83RD12M24M

Riduzione 1/2MxM24. Consente di collegare al lavabo/lavello M24 un qualsiasi componente con attacco 1/2F.
1/2MxM24 reduction. Connecting any component with 1/2F connection to the washbasin/sink M24.



83RD12F24M

Riduzione 1/2FxM24. Consente di collegare al lavabo/lavello M24 un qualsiasi componente con attacco 1/2M.
1/2FxM24 reduction. Connecting any component with 1/2M connection to the washbasin/sink M24.



82

Aeroflux a due getti, con doccetta a snodo, filetto F22 con riduzione M24.
Double spray aerator, with balljoint shower, thread F22 with reduction M24.



82DJ

Aeroflux "Dual Jet" in ottone a due getti, con doccetta a snodo e filetto F22.
Double spray brass shower-aerator "Dual Jet", with ball-joint shower, thread F22.



82UN

Aeroflux a due getti, con doccetta a snodo, con attacco universale.
Double spray aerator, with balljoint shower, with standard connection.



82L

Aeroflux a due getti, con manicotto a vite, lunghezza cm 15.
Double spray aerator, with screw standard connection, length 15 cm.



82LGH

Aeroflux a due getti, con ghiera e filetto F22, lunghezza 15 cm.
Double spray aerator, with nut and thread F22, length 15 cm.

— ECCENTRICI E DISTANZIATORI - ECCENTRICS & CONNECTIONS —



89
Eccentrico per gruppi, 1/2x3/4, con rosone in ottone.
Eccentric unions for mixers, 1/2x 3/4, with Brass flange.



89L
Eccentrico per gruppi, 1/2x3/4, tipo Lusso, con rosone in ottone.
Eccentric unions for mixers, 1/2x3/4, with Brass flange, luxury type.



89N
Eccentrico per gruppi, 1/2x3/4, con rosone minimale in ottone.
Eccentric unions for mixers, 1/2x3/4, with minimal Brass flange.



90
Distanziatore per gruppi, 1/2x3/4, lunghezza cm.4, 6, 8.
Brass S-connection for mixers, 1/2x3/4, length 4, 6, 8 cm.

cm 4 cm 6 cm 8

— BOCCHE - SPOUTS —



86
Canna lavello inferiore a "S", cm 22,5, tipo universale, con aeratore.
Lower "S" sink spout, cm 22,5, universal type, with aerator.



86N
Canna lavello inferiore a "S", cm 20, con aeratore.
Lower "S" sink spout, cm 20, with aerator.



86N40
Canna lavello inferiore a "S", cm 40, con aeratore.
Lower "S" sink spout, cm 40, with aerator.



86U
Canna lavello superiore a "U", cm 20, con aeratore.
Upper "U" sink spout, cm 20, with aerator.



87N
Canna a "J" per monoforo lavello, con aeratore.
"J" spout for one-hole sink mixer, with aerator.



87
Canna a "J" per monoforo lavello, tipo universale, con aeratore.
"J" spout for one-hole sink mixer, universal type, with aerator.



92C
Canna a biscotto a "C" con calotta da 3/4, con aeratore.
"C" spout with nut 3/4, with aerator.



92CC
Canna a biscotto a "C" con calotta da 3/4, con aeratore, tipo corto.
"C" spout with nut 3/4, with aerator, short type.



92U
Canna a "U" Ø 22, con aeratore.
"U" spout Ø 22, with aerator.



93
Canna a fusa lunga cm 30 con deviatore, con calotta da 3/4 ed aeratore.
Casted cm 30 long spout with diverter, with 3/4 nut, with aerator.



9216
Canna a biscotto diritta, calotta da 3/4, lunghezza cm 16, con aeratore.
Straight spout with 3/4 nut, 16 cm long, with aerator.



9220
Canna a biscotto diritta, calotta da 3/4, lunghezza cm 20, con aeratore.
Straight spout with 3/4 nut, 20 cm long, with aerator.



92B
Canna a "C" con aeratore.
"C" spout with aerator.



9230
Canna a biscotto diritta, calotta da 3/4, lunghezza cm 30, con aeratore.
Straight spout with 3/4 nut, 30 cm long, with aerator.



9240
Canna a biscotto diritta, calotta da 3/4, lunghezza cm 40, con aeratore.
Straight spout with 3/4 nut, 40 cm long, with aerator.



9250
Canna a biscotto diritta, calotta da 3/4, lunghezza cm 50, con aeratore.
Straight spout with 3/4 nut, 50 cm long, with aerator.



92 S16
Canna a biscotto a "S", calotta da 3/4, lunghezza cm 16, con aeratore.
"S" spout with 3/4 nut, 16 cm long, with aerator.



92 S20
Canna a biscotto a "S", calotta da 3/4, lunghezza cm 20, con aeratore.
"S" spout with 3/4 nut, 20 cm long, with aerator.



92 S30
Canna a biscotto a "S", calotta da 3/4, lunghezza cm 30, con aeratore.
"S" spout with 3/4 nut, 30 cm long, with aerator.

SCARICHI - WASTES



95TA
Tappo scarico automatico in ottone per piletta 1" e per piletta 1"1/4.
Brass plug for pop-up waste for drain 1" and for drain 1"1/4.

1" 1" 1/4



95TAG
Tappo grande in ottone per scarico automatico con piletta da 1"1/4.
Big plug in brass for pop-up waste with drain 1"1/4.



95TAS
Tappo grande quadrato in ottone per scarico automatico con piletta da 1"1/4.
Squared big plug in brass for pop-up waste with drain 1"1/4.



96TA
Tappo in ottone per colonna vasca automatica.
Chrome plated brass plug for automatic bath waste and overflow.



BAK10
Basetta in ottone per rubinetteria tipo serie Kiss, Ten, Giga.
Base in brass for mixers like serie Kiss, Ten, Giga.



94
Asta per scarico automatico, lunghezza cm 30, in ottone.
Rod for pop-up waste, length 30 cm, in brass.



95AC
Asta e centralina bidet per scarico automatico, in ottone.
Rod and flange for bidet for pop-up automatic waste, in brass.



80SN
Morsetto con vite per scarico automatico.
Joint with screw for pop-up waste.



95QAC
Asta e centralina bidet per scarico automatico, in ottone.
Rod and flange for bidet for pop-up automatic waste, in brass.



AST10
Asta con pomolo e snodino per serie Ten, in ottone.
Rod with knob and small joint for Ten series, in brass.



ASK10
Asta con pomolo e snodino per serie Kiss, in ottone.
Rod with knob and small joint for Kiss series, in brass.



FISK10
Confezione di fissaggio per art. K10, K20, K40.
Fixing set for art. K10, K20, K40.



FISR10
Confezione di fissaggio per art. R10, R20, R40.
Fixing set for art. R10, R20, R40.



FIST10
Confezione di fissaggio a doppio tirante.
Fixing set with double screw.



FISA10
Confezione di fissaggio per: Atmos, Flash, Qubika Cascata.
Fixing set for: Atmos, Flash, Qubika Waterfall.



FISB10
Confezione di fissaggio per art. S42 U, S10 G, B10, B20, Q42U, Q10 G.
Fixing set for art. S42 U, S10 G, B10, B20, Q42U, Q10 G.

DOCCHETTE CUCINA - KITCHEN HANDSHOWER

K66DONE



Doccetta per parrucchiere, nera.
Handshower for hairdresser, black.



SENZA SCATOLA WITHOUT BOX	CON SCATOLA WITH BOX
K66DONE	K66DONEX

331K47



Doccetta cromata per monoforo livello.
Pull-out handshower for single-hole sink mixer.



CROMATA - CHROME PLATED		BIANCA - WHITE	
SENZA SCATOLA WITHOUT BOX	CON SCATOLA WITH BOX	SENZA SCATOLA WITHOUT BOX	CON SCATOLA WITH BOX
331K47	331K47X	331K47BI	331K47BIX

331



Doccetta per monoforo livello.
Handshower for single-hole sink mixer.



SENZA SCATOLA WITHOUT BOX	CON SCATOLA WITH BOX
331	331X

331N82



Doccetta cromata per monoforo livello, a due funzioni.
Pull-out handshower for single-hole sink mixer, two functions.



SENZA SCATOLA WITHOUT BOX	CON SCATOLA WITH BOX
331N82	331N82X

331N82C



Doccetta cromata per monoforo livello, a due funzioni.
Pull-out handshower for single-hole sink mixer, two functions.



SENZA SCATOLA WITHOUT BOX	CON SCATOLA WITH BOX
331N82C	331N82CX

331N83A



Doccetta cromata per monoforo livello, a due funzioni.
Pull-out handshower for single-hole sink mixer, two functions.



SENZA SCATOLA WITHOUT BOX	CON SCATOLA WITH BOX
331N83A	331N83AX

331N83B



Doccetta cromata per monoforo livello, a due funzioni.
Pull-out handshower for single-hole sink mixer, two functions.



SENZA SCATOLA WITHOUT BOX	CON SCATOLA WITH BOX
331N83B	331N83BX

331DJN



Doccetta cromata per lavello monoforo, 2 funzioni.
Pull-out handshower for single-hole sink mixer, 2 functions.

SENZA SCATOLA WITHOUT BOX	CON SCATOLA WITH BOX
331DJN	331DJNX

331DJC



Doccetta cromata per lavello monoforo, 2 funzioni.
Pull-out handshower for single-hole sink mixer, 2 functions.

SENZA SCATOLA WITHOUT BOX	CON SCATOLA WITH BOX
331DJC	331DJCX

331DJD



Doccetta cromata per lavello monoforo, 2 funzioni.
Pull-out handshower for single-hole sink mixer, 2 functions.

SENZA SCATOLA WITHOUT BOX	CON SCATOLA WITH BOX
331DJD	331DJDx

331N85



Doccetta cromata per lavello monoforo, 2 funzioni.
Pull-out handshower for single-hole sink mixer, 2 functions.

SENZA SCATOLA WITHOUT BOX	CON SCATOLA WITH BOX
331N85	331N85X

331N86



Doccetta cromata per lavello monoforo, 2 funzioni.
Pull-out handshower for single-hole sink mixer, 2 functions.

SENZA SCATOLA WITHOUT BOX	CON SCATOLA WITH BOX
331N86	331N86X

331N87



Doccetta cromata per lavello monoforo, 2 funzioni.
Pull-out handshower for single-hole sink mixer, 2 functions.

SENZA SCATOLA WITHOUT BOX	CON SCATOLA WITH BOX
331N87	331N87X

331N78



Doccetta cromata per lavello monoforo, 1 funzione con pulsante di azionamento.
Pull-out handshower for single-hole sink mixer, 1 function with on off botton.

SENZA SCATOLA WITHOUT BOX	CON SCATOLA WITH BOX
331N78	331N78X

331NR78



Doccetta cromata per monoforo lavello, ad una funzione con luce led ed attacco da 1/2.
Pull-out handshower for single-hole sink mixer, one function with led light and 1/2 connection.

SENZA SCATOLA WITHOUT BOX	CON SCATOLA WITH BOX
331NR78	331NR78X

331NR7824



Doccetta cromata per monoforo lavello, ad una funzione con luce led ed attacco da 24x1.
Pull-out handshower for single-hole sink mixer, one function with led light and 24x1 connection.

SENZA SCATOLA WITHOUT BOX	CON SCATOLA WITH BOX
331NR7824	331NR7824X





INOX DESIGN



X STYLE INOX

pag. 304



WELLNESS INOX

pag. 308



ACCESSORI INOX | *INOX ACCESSORIES*

pag. 320



CUCINA INOX | *INOX KITCHEN*

pag. 324

X STYLE INOX



Nella collezione X-STYLE INOX, il design slanciato e minimale della rubinetteria X-STYLE viene completamente realizzato in acciaio INOX aggiungendo alle sue forme fluide ed essenziali, la bellezza e la resistenza dell'acciaio inossidabile. La serie è dotata di cartuccia a dischi ceramici Ø 25 mm.

With the X-STYLE INOX collection, the minimal and slender design of X-STYLE faucet series is completely made of stainless steel, adding to the fluid and essential shapes the beauty and the strength of this material. The series is equipped with a Ø 25 mm ceramic disc cartridge.



X STYLE INOX

WELLNESS INOX

ACCESSORI INOX
INOX ACCESSORIESCUCINA INOX
INOX KITCHEN

LAVABI E BIDET - WASHBASINS AND BIDET MIXERS



Monocomando lavabo.
Single-lever basin mixer.

SSX10B

con scarico click-clack con troppopieno e senza foro sul corpo.
with click-clack waste with overflow and without body hole.



SSX12

senza scarico e senza foro sul corpo.
without waste and without body hole.



Miscelatore monocomando lavabo alto L.
Single-lever basin mixer L high neck.

SSX10LXLB

con scarico click-clack con troppopieno e senza foro sul corpo.
with click-clack waste with overflow and without body hole.



SSX12LXL

senza scarico e senza foro sul corpo.
without waste and without body hole.

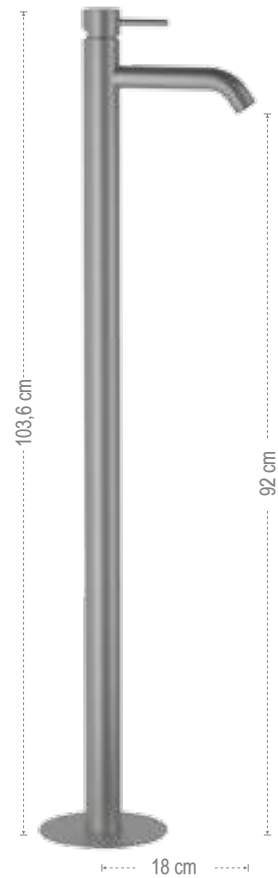

SSX18

Miscelatore monocomando lavabo da pavimento con scarico click-clack e troppopieno.
Single-lever mixer floor mounting with click-clack waste with overflow.

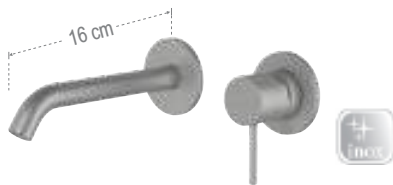

SSX15P

Miscelatore monocomando a incasso per lavabo, in ottone.
Single-lever built-in basin mixer, in chrome plated brass.

SSX15PL

Lunghezza bocca 23 cm.
Spout length 23 cm.



SS91X

Bocca incasso.
Built-in spout.

SS91XL

Lunghezza bocca 23 cm.
Spout length 23 cm.

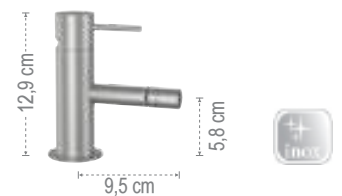

Monocomando bidet.

Single-lever bidet mixer

SSX20B

con scarico click-clack con troppopieno.
with click-clack waste with overflow.



SSX22

senza scarico e senza foro sul corpo.
without waste and without body hole.



INCASSI DOCCIA - BUILT-IN MIXERS

**SSX92P**

Miscelatore monocomando per doccia con deviatore a 2 posizioni con doppia piastra.
Single-lever shower mixer, with 2 positions diverter on double flange.

**SSX93P**

Miscelatore monocomando per doccia con deviatore a 3 vie e 3 posizioni (una entrata e tre uscite) i con doppia piastra.
Single lever built-in shower mixer with 3 ways diverter and 3 positions (1 inlet and 3 outlets) on double flange.

**SSX30L**

Miscelatore doccia incasso.
Built-in shower mixer.

**SSXT09Q**

Miscelatore doccia incasso termostatico con deviatore a pulsante su piastra rettangolare.
Thermostatic built-in shower mixer with push-button diverter and rectangular plate.

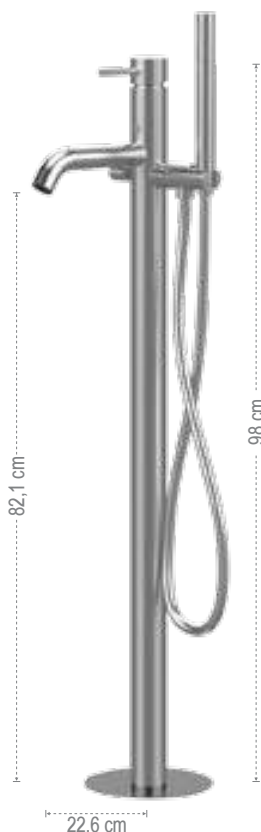

MISCELATORI VASCA DOCCIA - BATH SHOWER MIXES

**SSX08**

Miscelatore vasca da pavimento con deviatore, doccetta ad 1 funzione tutto in acciaio INOX spazzolato e flessibile in pvc color grigio acciaio 150 cm.
Free standing bath mixer floor mounting with diverter, 1 function handshower all in brushed stainless steel and and 150 cm pvc steel grey colour flexible hose.

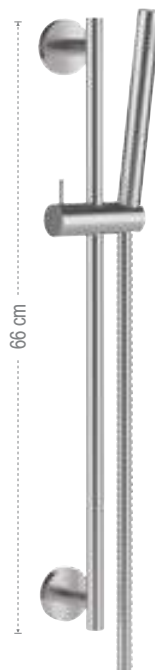
**SS317M317MM**

Saliscendi minimale con doccetta ad 1 funzione tutto in acciaio INOX spazzolato e flessibile in pvc color grigio acciaio 150 cm.
Minimal sliding rail set with 1 function handshower all in brushed stainless steel and and 150 cm pvc steel grey colour flexible hose.



Termostatico vasca esterno.
Exposed bath thermostatic.

SSXT02

con kit doccia, flessibile 150 cm e doccetta ad una funzione.
with shower kit, flexible 150 cm and one function brass minimal handshower.

**SSXT05**

senza kit doccia.
without shower kit.



Termostatico doccia esterno.
Exposed shower thermostatic.

SSXT39

con kit doccia, flessibile 150 cm e doccetta ad una funzione.
with shower kit, flexible 150 cm and one function brass minimal handshower.

**SSXT31**

senza kit doccia.
without shower kit.

WELLNESS INOX

WELLNESS INOX



Una selezione completa di articoli dedicati all'interno doccia e di accessori bagno, tutti realizzati in acciaio inossidabile con finitura spazzolata: un materiale pratico, funzionale e resistente, sempre più apprezzato anche per la sua resa estetica nella progettazione di interni dal taglio moderno e minimalista.

A complete selection of items dedicated to shower interiors and bathroom accessories, all made of stainless steel with brushed finish: a practical, functional and resistant material, increasingly appreciated also for its aesthetic performance in the design of interiors with a modern and minimalist cut.



X STYLE INOX

WELLNESS INOX

ACCESSORI INOX
INOX ACCESSORIESCUCINA INOX
INOX KITCHEN

COLONNE DOCCIA - SHOWER COLUMNS



SSX37UFM25

Colonna doccia con miscelatore esterno doccia con deviatore integrato, doccetta ad 1 funzione e soffione Ø25 cm anticalcare.
 Shower column with external shower mixer with integrated diverter, 1 function handshower and Ø25 cm shower head.



SSXT37UFM25

Colonna doccia con miscelatore esterno doccia termostatico con deviatore integrato, doccetta ad 1 funzione e soffione Ø25 cm anticalcare.
 Shower column with thermostatic external shower mixer with integrated diverter, 1 function handshower and Ø25 cm shower head.



WELLNESS



Set doccia composto da: miscelatore a incasso in acciaio inox con deviatore a 2 posizioni, soffione in acciaio inox SS357UFM20X, braccio in acciaio inox 30 cm, saliscendi in acciaio inox spazzolato SS317M, presa acqua a muro, doccetta minimale in acciaio inox, 1 funzione SS317MM, flessibile in PVC 150 cm.

Shower set including: stainless steel built-in mixer with 2-position diverter, stainless steel shower head SS357UFM20X, stainless steel arm 30 cm, brushed stainless steel sliding rail SS317M, wall water connection, 1-function stainless steel hand shower SS317MM, 150 cm PVC flexible hose.



SSX92PS01UFM20

con soffione da cm Ø20 cm e braccio a parete 30 cm.
 with shower head cm Ø20 cm and wall arm 30 cm.

SSX92PS01UFM25

con soffione da cm Ø25 cm e braccio a parete 30 cm
 Available with shower head cm Ø25 cm and wall arm 30 cm.

SSX92PS01UFM30

con soffione da cm Ø30 cm e braccio a parete 30 cm.
 with shower head cm Ø30 cm and wall arm 30 cm.

SSX92PS21UFM20

con soffione da cm Ø20 cm e braccio a soffitto da 30 cm.
 with shower head cm Ø20 cm and ceiling arm 30 cm.



Set doccia composto da: miscelatore a incasso in acciaio inox con deviatore a 2 posizioni, soffione in acciaio inox SS357UFM20X, braccio in acciaio inox 30 cm, presa acqua a muro con supporto doccetta, doccetta minimale in acciaio inox, 1 funzione SS317MM, flessibile in PVC 150 cm.
 Shower set including: stainless steel built-in mixer with 2-position diverter, stainless steel shower head SS357UFM20X, stainless steel arm 30 cm, wall water connection with shower holder, 1-function stainless steel hand shower SS317MM, 150 cm PVC flexible hose.



SSX92PS02UFM20

con soffione da cm Ø20 cm e braccio a parete 30 cm.
 with shower head cm Ø20 cm and wall arm 30 cm.

SSX92PS02UFM25

con soffione da cm Ø25 cm e braccio a parete 30 cm.
 with shower head cm Ø25 cm and wall arm 30 cm.

SSX92PS02UFM30

con soffione da cm Ø30 cm e braccio a parete 30 cm.
 with shower head cm Ø30 cm and wall arm 30 cm.

SSX92PS22UFM20

con soffione da cm Ø20 cm e braccio a soffitto da 30 cm.
 with shower head cm Ø20 cm and ceiling arm 30 cm.



Set doccia composto da: miscelatore a incasso in acciaio inox con deviatore a 3 vie, soffione in acciaio inox SS357UFM20X, braccio in acciaio inox 30 cm, saliscendi in acciaio inox spazzolato SS317M, presa acqua a muro, doccetta minimale in acciaio inox, 1 funzione SS317MM, 6 getti tondi, flessibile in PVC 150 cm.

Shower set including: stainless steel built-in mixer with 3-way diverter, stainless steel shower head SS357UFM20X, stainless steel arm 30 cm, brushed stainless steel sliding rail SS317M, wall water connection, 1-function stainless steel hand shower SS317MM, 6 round body jets, 150 cm PVC flexible hose.



SSX93PS01UFM20

con soffione da cm Ø20 cm e braccio a parete 30 cm.
with shower head cm Ø20 cm and wall arm 30 cm.

SSX93PS01UFM25

con soffione da cm Ø25 cm e braccio a parete 30 cm.
with shower head cm Ø25 cm and wall arm 30 cm.

SSX93PS01UFM30

con soffione da cm Ø30 cm e braccio a parete 30 cm.
with shower head cm Ø30 cm and wall arm 30 cm.

SSX93PS21UFM20

con soffione da cm Ø20 cm e braccio a soffitto da 30 cm.
with shower head cm Ø20 cm and ceiling arm 30 cm.



Set doccia composto da: miscelatore a incasso in acciaio inox con deviatore a 3 vie, soffione in acciaio inox SS357UFM20X, braccio in acciaio inox 30 cm, presa acqua a muro con supporto doccetta, doccetta minimale in acciaio inox, 1 funzione SS317MM, 6 getti tondi, flessibile in PVC 150 cm.

Shower set including: stainless steel built-in mixer with 3-way diverter, stainless steel shower head SS357UFM20X, stainless steel arm 30 cm, wall water connection with shower holder, 1-function stainless steel hand shower SS317MM, 6 round body jets, 150 cm PVC flexible hose.



SSX93PS02UFM20

con soffione da cm Ø20 cm e braccio a parete 30 cm.
with shower head cm Ø20 cm and wall arm 30 cm.

SSX93PS02UFM25

con soffione da cm Ø25 cm e braccio a parete 30 cm.
with shower head cm Ø25 cm and wall arm 30 cm.

SSX93PS02UFM30

con soffione da cm Ø30 cm e braccio a parete 30 cm.
with shower head cm Ø30 cm and wall arm 30 cm.

SSX93PS22UFM20

con soffione da cm Ø20 cm e braccio a soffitto da 30 cm.
with shower head cm Ø20 cm and ceiling arm 30 cm.



SSX93PS01MMCA

Set doccia composto da: miscelatore a incasso in acciaio inox con deviatore a 3 vie, soffione a parete in acciaio inox con getto a pioggia e cascata SS350MMCA, saliscendi in acciaio inox spazzolato SS317M, presa acqua a muro, doccetta minimale in acciaio inox, 1 funzione SS317MM, flessibile in PVC 150 cm.

Shower set including: stainless steel built-in mixer with 3-way diverter, wall mounted stainless steel shower head with rain and waterfall functions SS350MMCA, brushed stainless steel sliding rail SS317M, wall water connection, 1-function stainless steel hand shower SS317MM, 150 cm PVC flexible hose.



SSX93PS02MMCA

Set doccia composto da: miscelatore a incasso in acciaio inox con deviatore a 3 vie, soffione a parete in acciaio inox con getto a pioggia e cascata SS350MMCA, presa acqua a muro con supporto doccetta, doccetta minimale in acciaio inox, 1 funzione SS317MM, flessibile in PVC 150 cm.

Shower set including: stainless steel built-in mixer with 3-way diverter, wall mounted stainless steel shower head with rain and waterfall functions SS350MMCA, wall water connection with shower holder, 1-function stainless steel hand shower SS317MM, 150 cm PVC flexible hose.



KIT SENZA MISCELATORE ACCIAIO INOX SPAZZOLATO
KIT WITHOUT SHOWER MIXER BRUSHED STAINLESS STEEL



Set doccia composto da: soffione in acciaio inox SS357UFM20X, braccio in acciaio inox 30 cm, presa acqua a muro con supporto doccetta, doccetta minimale in acciaio inox, 1 funzione SS317MM, flessibile in PVC 150 cm.
Shower set including: stainless steel shower head SS357UFM20X, stainless steel arm 30 cm, wall water connection with shower holder, 1-function stainless steel hand shower SS317MM, 150 cm PVC flexible hose.



SSSETS02UFM20

con soffione da cm Ø20 cm e braccio a parete 30 cm.
with shower head cm Ø20 cm and wall arm 30 cm.

SSSETS02UFM25

con soffione da cm Ø25 cm e braccio a parete 30 cm.
with shower head cm Ø25 cm and wall arm 30 cm.

SSSETS02UFM30

con soffione da cm Ø30 cm e braccio a parete 30 cm.
with shower head cm Ø30 cm and wall arm 30 cm.



Set doccia composto da: soffione in acciaio inox SS357UFS20X, braccio in acciaio inox 30 cm, presa acqua a muro con supporto doccetta, doccetta piatta in acciaio inox a 1 funzione SS317RR, flessibile in PVC 150 cm.
Shower set including: stainless steel shower head SS357UFS20X, stainless steel arm 30 cm, wall water connection with shower holder, 1-function stainless steel flat hand shower SS317RR, 150 cm PVC flexible hose.



SSSETS027RRUFS20

con soffione da cm 20x20 cm e braccio a parete 30 cm.
with shower head cm 20x20 cm and wall arm 30 cm.

SSSETS027RRUFS25

con soffione da cm 25x25 cm e braccio a parete 30 cm.
with shower head cm 25x25 cm and wall arm 30 cm.

SSSETS027RRUFS30

con soffione da cm 30x30 cm e braccio a parete 30 cm.
with shower head cm 30x30 cm and wall arm 30 cm.

SALISCENDI CON DOCCIA - SLIDING RAILS WITH HANDSHOWER



SS317M317MM

Saliscendi minimale con doccetta ad 1 funzione tutto in acciaio INOX spazzolato. Flessibile 150 cm. Altezza 60 cm.
Minimal sliding rail set with 1 function handshower all in brushed stainless steel. Flexible hose 150 cm. Height 60 cm.



SS317M332

Saliscendi in acciaio INOX spazzolato con asta tonda e centralina in acciaio INOX con flessibile in pvc 150 cm senza doccetta, in scatola con finestra.
Brushed stainless steel sliding rail set and stainless steel sliding shower holder, with pvc flexible hose 150 cm without handshower, in box.



IDROSCOPINI - HYDRO-BRUSH



SSRB150S01

Set wc in acciaio inox 316L, idroscopino con flessibile 120cm, attacco G1/2".
Stainless steel 316L wc set, hydro-brush with cm 120 flexible hose, G1"1/2 connection.



SSRB150

Doccetta idroscopino in acciaio inox 316L anticalcare.
Hydro-brush wc handspray, stainless steel 316L, anti limestone.



SS338M332ON

Set doccetta igienica in acciaio inox con flessibile 120cm, attacco G1/2".
Stainless steel shut-off handshower with cm 120 flexible hose, G1"1/2 connection.



SSX60P

Set doccetta igienica in acciaio inox con flessibile 120cm, attacco G1/2", incasso con miscelazione, cartuccia Ø25.
Stainless steel shut-off set with handshower, cm 120 flexible hose, G1"1/2 connection, Ø25 cartridge built-in shut-off mixer.



SS332ON

Doccetta igienica shut-off inox 316L anticalcare.
Stainless steel 316L anti limestone shut-off handshower.

KIT SUPPORTO CON PRESA ACQUA E DOCGETTA
HANDSHOWER AND WATER PUNCH WITH SHOWER HOLDER KIT



SS337M317MM

**SS337M317MM**

Set doccia minimale in acciaio INOX spazzolato composto da: presa acqua con supporto lusso, doccetta ad 1 funzione e flessibile in pvc color grigio acciaio 150 cm.

Minimal brushed stainless steel shower set composed of: water punch shower holder, and 1 function handshower and 150 cm pvc steel grey colour flexible hose.

X STYLE INOX

WELLNESS INOX

ACCESSORI INOX
INOX ACCESSORIESCUCINA INOX
INOX KITCHEN

SOFFIONI LINEA QUADRATA - SQUARED LINE SHOWER HEAD

**SS350SSX**

Soffione doccia anticalcare a parete 50x20 cm, in acciaio INOX spazzolato.
Brushed stainless steel wall shower head antilimestone 50x20 cm.

**SS350SSCAX**

Soffione doccia anticalcare a parete 50x20 cm, in acciaio INOX spazzolato, 2 funzioni: getto a pioggia e cascata.
Brushed stainless steel wall shower head antilimestone, 2 functions: rain and waterfall, 50x20 cm.

**SS350UFX**

Soffione doccia anticalcare ultrapiatto 50x25 cm, a parete in acciaio INOX spazzolato.
Ultraslim antilimestone brushed stainless steel wall shower head 50x25 cm.

**SS350UFCAX**

Soffione doccia anticalcare ultrapiatto 50x25 cm, a parete in acciaio INOX spazzolato, 2 funzioni: getto a pioggia e cascata.
Ultraslim antilimestone brushed stainless steel wall shower head, 2 functions: rain and waterfall, 50x25 cm.



SOFFIONI A SOFFITTO "EASY FIX" - CEILING SHOWER HEAD "EASY FIX"

**SS357EFM34**

Soffione doccia EASY FIX in acciaio INOX spazzolato Ø34 cm. Con getti anticalcare.
EASY FIX brushed stainless steel shower head Ø34 cm.
With antilimestone jets.

**SS357EFM44**

Soffione doccia EASY FIX in acciaio INOX spazzolato Ø44 cm. Con getti anticalcare.
EASY FIX brushed stainless steel shower head Ø44 cm.
With antilimestone jets.

**SS357EFS34**

Soffione doccia EASY FIX in acciaio INOX spazzolato 34x34 cm. Con getti anticalcare.
EASY FIX brushed stainless steel shower head 34x34 cm.
With antilimestone jets.

**SS357EFS44**

Soffione doccia EASY FIX in acciaio INOX spazzolato 44x44 cm. Con getti anticalcare.
EASY FIX brushed stainless steel shower head 44x44 cm.
With antilimestone jets.

APPLICAZIONE A SOFFITTO "EASY FIX" - "EASY FIX" CEILING APPLICATION

1

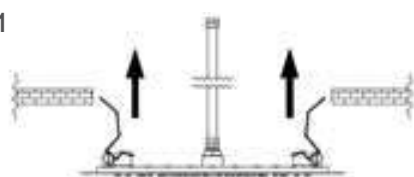

Per questa tipologia di soffione e con questo specifico sistema di fissaggio sono previste quattro molle per ogni soffione.

Nell'immagine 1 si evidenzia il primo movimento necessario: caricare due molle vicine tra loro mettendole quasi in posizione verticale rispetto al soffione ed inserirle all'interno del foro precedentemente preparato. Rilasciare le stesse delicatamente.

For this specific shower-head with this specific mounting system, four springs are installed on each head.

In picture 1, you shall see the first needed movement to activate them:

Spring-load two springs next to each other placing them almost vertically and insert them in the hole in the ceiling;

Release them gently;

2

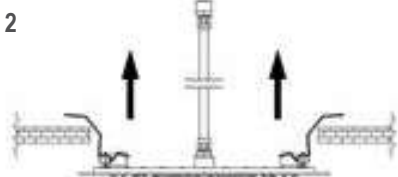

Mantenendo il soffione leggermente inclinato procedere caricando ed inserendo le rimanenti due molle come da immagine 2.

While keeping the shower head slightly inclined, proceed by spring-loading and inserting the two other springs as shown in picture 2.

3

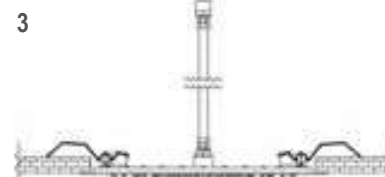

A questo punto rilasciare delicatamente le molle alla loro naturale tensione e, trattenendo esternamente il soffione, accompagnare lo stesso verso il totale appoggio al soffitto come da immagine 3.

Now release the springs back to their natural tension and, while holding the head from outside, guide it to its final position as shown in picture 3.

SOFFIONI A SOFFITTO CON TELAIO - CEILING SHOWER HEAD WITH FIXING SET

**SS357SFS43**

Soffione a soffitto in Acciaio INOX spazzolato, getti anticalcare, 43x43 cm con getto a pioggia.

Ceiling brushed stainless steel shower head , antilimestone jets, 43x43 cm, with rain jet.

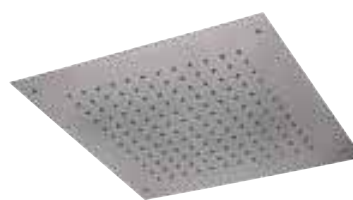
**SS357SFS50**

Soffione a soffitto in Acciaio INOX spazzolato, getti anticalcare, 50x50 cm con getto a pioggia.

Ceiling brushed stainless steel shower head, antilimestone jets, 50x50 cm, with rain jet.

**SS357SFS43C**

Soffione a soffitto in Acciaio INOX spazzolato, getti anticalcare, 43x43 cm, a 2 funzioni: pioggia e cascata.

Ceiling brushed stainless steel shower head, antilimestone jets, 43x43 cm, 2 functions: rain and waterfall.

**SS357SFS50C**

Soffione a soffitto in Acciaio INOX spazzolato, getti anticalcare, 50x50 cm, a 2 funzioni: pioggia e cascata.

Ceiling brushed stainless steel shower head, antilimestone jets, 50x50 cm, 2 functions: rain and waterfall.

**SS357SFS43NC**

Soffione a soffitto in Acciaio INOX spazzolato, getti anticalcare, 43x43 cm, a 3 funzioni: pioggia, nebulizzazione (4 uscite) ed 1 getto a cascata.

Ceiling brushed stainless steel shower head, antilimestone jets, 43x43 cm, 3 functions: rain jet, nebulization (4 outlet) and waterfall.

**SS357SFS50NC**

Soffione a soffitto in Acciaio INOX spazzolato, getti anticalcare, 50x50 cm, a 3 funzioni: pioggia, nebulizzazione (4 uscite) ed 1 getto a cascata.

Ceiling brushed stainless steel shower head , antilimestone jets, 50x50 cm, 3 functions: rain, nebulization (4 outlet) and waterfall.



X STYLE INOX

WELLNESS INOX

ACCESSORI INOX
INOX ACCESSORIESCUCINA INOX
INOX KITCHEN

CROMOTERAPIA - COLOR THERAPY

IN DOTAZIONE IN BASE AI MODELLI - SUPPLIED DEPENDING ON THE MODELS



Pulsantiera a parete per accensione luce bianca, selezione colori e cromoterapia automatica. Wall push-button to turn, on, select the colors and change of the jet.

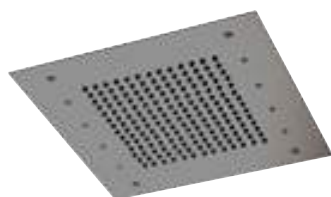

W Pulsantiera wireless per accensione luce bianca, selezione colori e cromoterapia automatica. Wireless push-button to turn, on, select the colors and change of the jet.

**SS357RS43**

Soffione a soffitto in Acciaio INOX spazzolato 43x43 cm, getto a pioggia anticalcare. Luce LED a 7 colori con 40 sfumature, alimentazione dalla rete elettrica con trasformatore a basso voltaggio incluso (12V). Pulsantiera a parete inclusa.

Ceiling brushed stainless steel shower head 43x43 cm, with antilimestone rain jet. 7 colors light led with 40 shades. Powered by electricity with low voltage transformer included (12V). Wall push-button included.

**SS357RS50**

Soffione a soffitto in Acciaio INOX spazzolato 50x50 cm, getto a pioggia anticalcare. Luce LED a 7 colori con 40 sfumature, alimentazione dalla rete elettrica con trasformatore a basso voltaggio incluso (12V). Pulsantiera a parete inclusa.

Ceiling brushed stainless steel shower head 50x50 cm, with antilimestone rain jet. 7 colors light led with 40 shades. Powered by electricity with low voltage transformer included (12V). Wall push-button included.

**SS357RS43W**

Come soffione Art. 357 RS43, con pulsantiera wireless inclusa. As art. 357 RS43, with wireless remote control included.

**SS357RS50W**

Come soffione Art. 357 RS50, con pulsantiera wireless inclusa. As art. 357 RS50W, with wireless remote control included.

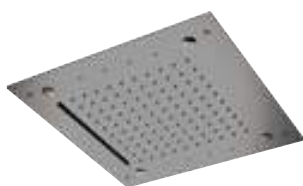
**SS357RS43NC**

Soffione a soffitto in Acciaio INOX spazzolato 43x43 cm, con 3 funzioni: getto a pioggia anticalcare, nebulizzazione (4 uscite) e getto a cascata. Luce LED a 7 colori con 40 sfumature, alimentazione dalla rete elettrica con trasformatore a basso voltaggio incluso (12V). Pulsantiera a parete inclusa.

Ceiling brushed stainless steel shower head 43x43 cm, with 3 functions: antilimestone rain jet, nebulization (4 outlets) and 1 waterfall jet. 7 colors light led with 40 shades. Powered by electricity with low voltage transformer included (12V). Wall push-button included.

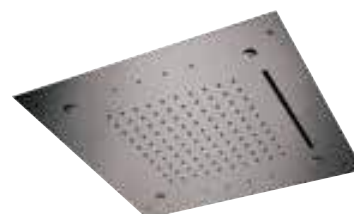
**SS357RS50NC**

Soffione a soffitto in Acciaio INOX spazzolato 50x50 cm, con 3 funzioni: getto a pioggia anticalcare, nebulizzazione (4 uscite) e getto a cascata. Luce LED a 7 colori con 40 sfumature, alimentazione dalla rete elettrica con trasformatore a basso voltaggio incluso (12V). Pulsantiera a parete inclusa.

Ceiling brushed stainless steel shower head 50x50 cm, with 3 functions: antilimestone rain jet, nebulization (4 outlets) and 1 waterfall jet. 7 colors light led with 40 shades. Powered by electricity with low voltage transformer included (12V). Wall push-button included.

**SS357RS43NCW**

Come soffione Art. 357 RS43 NC, con pulsantiera wireless inclusa. As art. 357 RS43 NC, with wireless remote control included.

**SS357RS50NCW**

Come soffione Art. 357 RS50 NC, con pulsantiera wireless inclusa. As art. 357 RS50 NC, with wireless remote control included.



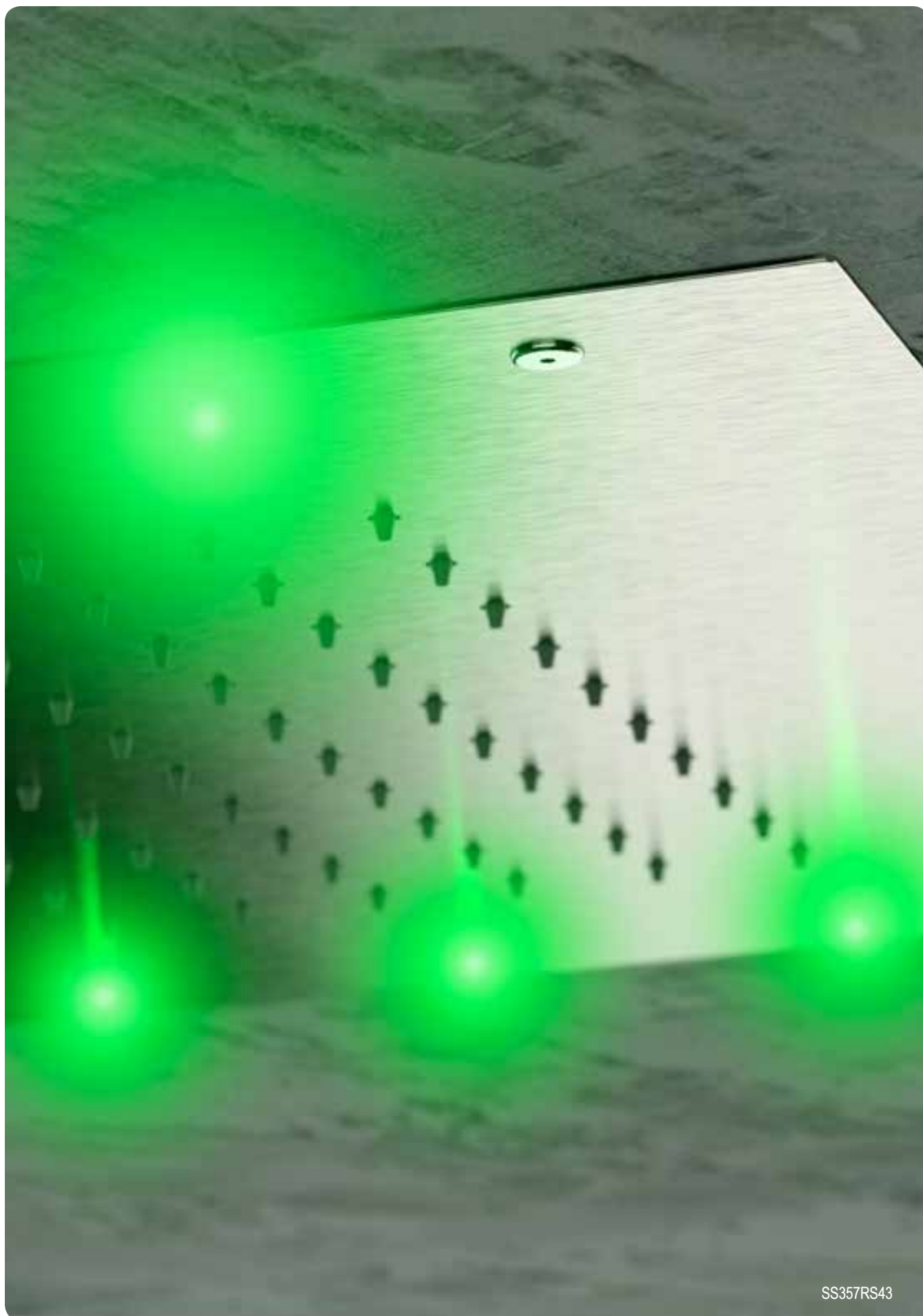

X STYLE INOX

WELLNESS INOX

ACCESSORI INOX
INOX ACCESSORIES

CUCINA INOX
INOX KITCHEN

SS357RS43



SS 357UFM25X

SOFFIONI GETTI - SHOWER HEAD & BODY JETS



SS357UFM20X
Soffione doccia tondo ultrapiatto Ø20 cm in acciaio INOX spazzolato.
Ultraslim round brushed stainless steel shower head Ø20 cm.



SS357UFM25X
Soffione tondo doccia ultrapiatto Ø25 cm in acciaio INOX spazzolato.
Ultraslim round brushed stainless steel shower head Ø25 cm.



SS357UFM30X
Soffione doccia tondo ultrapiatto Ø30 cm in acciaio INOX spazzolato.
Ultraslim round brushed stainless steel shower head Ø30 cm.



SS357UFM40X
Soffione doccia tondo ultrapiatto Ø40 cm in acciaio INOX spazzolato.
Ultraslim round brushed stainless steel shower head Ø40 cm.



SS350MMCAX
Soffione doccia 50x20 cm, a parete in acciaio INOX spazzolato, 2 funzioni: a pioggia e cascata.
Brushed stainless steel wall shower head, 2 functions: rain jet and waterfall, 50x20 cm.



SSNX34JET
Getto rotondo Ø 5 cm, in acciaio INOX spazzolato per sistema doccia, anticalcare, con snodo.
Round body jet Ø 5 cm, in brushed stainless steel for shower systems, antilimestone, with ball-joint.



SSQX34JET
Getto quadrato 5x5 cm, in acciaio INOX spazzolato per sistema doccia, anticalcare, con snodo.
Squared body jet 5x5 cm, in brushed stainless steel for shower systems, antilimestone, with ball-joint.





SS357UFS20X
Soffione doccia quadrato ultrapiatto
20x20 cm in acciaio INOX spazzolato.
*Ultraslim squared brushed stainless
steel shower head 20x20 cm.*



SS357UFS25X
Soffione doccia quadrato ultrapiatto
25x25 cm in acciaio INOX spazzolato.
*Ultraslim squared brushed stainless
steel shower head 25x25 cm.*



SS357UFS30X
Soffione doccia quadrato ultrapiatto
30x30 cm in acciaio INOX spazzolato.
*Ultraslim squared brushed stainless
steel shower head 30x30 cm.*



SS357UFS40X
Soffione doccia quadrato ultrapiatto
40x40 cm in acciaio INOX spazzolato.
*Ultraslim squared brushed stainless
steel shower head 40x40 cm.*



DOCCETTE - HANDSHOWERS

18,5 cm



SS317MMX
Doccetta minimale ad una funzione in acciaio INOX spazzolato.
In scatola.
*Minimal one function handshower, in brushed stainless steel.
In box*



21 cm



SS317RRX
Doccetta rettangolare minimale ultrapiatta, in acciaio INOX
spazzolato ad 1 funzione. In scatola.
*Extraflat rectangular handshower, in brushed stainless steel, 1
function. In box*



BRACCI DOCCIA - SHOWER ARMS



Braccio doccia tondo da soffitto, in acciaio INOX spazzolato.
Lunghezza braccio: 10, 20, 30 cm.
*Ceiling round shower arm, in brushed stainless steel.
Lenght arm: 10, 20, 30 cm.*

SS347N10	SS347N20	SS347N30



SS343L30
Braccio doccia tondo da parete, in acciaio INOX spazzolato, cm 30.
Wall round shower arm, in brushed stainless steel, cm 30.



PRESE ACQUA E SUPPORTI - WATER PUNCH & SHOWER HOLDER



SS337M
Supporto lusso con presa acqua minimale
in acciaio INOX spazzolato per incasso, per
flessibile con attacco conico.
*Minimal brushed stainless steel shower holder
water punch, for built-in and for conical nut flexible.*



SS339SOM
Supporto fisso minimale in acciaio INOX
spazzolato per flessibile con attacco conico.
*Minimal shower holder brushed stainless steel,
for conical nut flexible.*



SS309
Attacco presa acqua da 1/2 minimale in acciaio
INOX.
*Stainless steel wall connector, minimal type 1/2
for shower.*



**+ flessibile
+ clickclack**

ACCESSORI INOX

ACCESSORI INOX INOX ACCESSORIES



Una collezione completa di accessori per il bagno realizzati in acciaio inossidabile con finitura spazzolata. Una soluzione perfetta per l'arredo bagno in abbinamento alla rubinetteria X-STYLE INOX e alle proposte WELLNESS INOX.

A complete collection of bathroom accessories made of stainless steel with brushed finish. A perfect solution to complete bathroom interiors in combination with X-STYLE INOX faucets and WELLNESS INOX kits.



X STYLE INOX

WELLNESS INOX

ACCESSORI INOX
INOX ACCESSORIESCUCINA INOX
INOX KITCHEN



SSXI13A
Dispenser in acciaio INOX spazzolato.
Brushed stainless steel dispenser.



SSXI13
Dispenser per sapone liquido da parete con supporto tutto in acciaio INOX spazzolato.
Wall mounted soap dispenser with support all in brushed stainless steel.



SSXI15A
Bicchiere in acciaio INOX spazzolato.
Brushed stainless steel cup.



SSXI15
Portabicchiere da parete con bicchiere in acciaio INOX spazzolato.
Wall mounted cup holder with glass all in brushed stainless steel.



SSXI30
Portasalviette in acciaio INOX spazzolato, lunghezza cm 60.
Brushed stainless steel towel holder, lenght cm 60.



SSXI40L30
Portasalviette in acciaio INOX spazzolato, lunghezza cm 30.
Brushed stainless steel towel holder, lenght cm 30.





SSXI50
 Appendino in acciaio INOX spazzolato.
Brushed stainless steel hook.



SSXI61
 Portarotolo in acciaio INOX spazzolato.
Brushed stainless steel toilet paper holder.



SSXI62
 Portarotolo di ricambio in acciaio INOX spazzolato.
Brushed stainless steel spare toilet paper holder.



SSXI66A
 Portascopino in acciaio INOX spazzolato da pavimento.
Brushed stainless steel floor broom rack holder.



SSXI66
 Portascopino in acciaio INOX da parete spazzolato.
Wall brushed stainless steel broom rack holder.

X STYLE INOX

WELLNESS INOX

ACCESSORI INOX
INOX ACCESSORIESCUCINA INOX
INOX KITCHEN

SSXI61 - SSXI50

CUCINA INOX

CUCINA INOX INOX KITCHEN



Miscelatori per cucina in acciaio inossidabile: una soluzione per il lavello pratica, igienica e funzionale, estremamente resistente sia al tempo che all'usura. La scelta tra diversi modelli permette di soddisfare le necessità progettuali in cucine di ogni grandezza; la cura nel design, nella finitura e nei dettagli estetici rende il prodotto un elemento di eleganza anche nelle cucine a vista.

Stainless steel kitchen mixer faucets: a practical, hygienic and functional solution for sink, extremely resistant to both time and deterioration. The choice between different models allows to satisfy the design needs in kitchens of all sizes; the attention to design, finish and aesthetic details makes the product an element of elegance even in open kitchens.



X STYLE INOX

WELLNESS INOX

ACCESSORI INOX
INOX ACCESSORIESCUCINA INOX
INOX KITCHEN



SSX72

Miscelatore monocomando per lavello, con bocca girevole, areatore anticalcare M22x1, acciaio inox spazzolato 316L.
Single-lever sink mixer, with swivel spout, M22x1 anti-limescale aerator, brushed stainless steel 316L.



SSX72U

Miscelatore monocomando per lavello in acciaio inox 316L spazzolato, canna quadra a "U" girevole.
Single-lever sink mixer in brushed 316L stainless steel, square "U" swivel spout.



SSX543

Miscelatore monocomando per lavello in acciaio inox 316L, bocca con flessibile a molla, doccetta orientabile a due getti, anticalcare.
Single-lever sink mixer in 316L stainless steel, spout with spring hose, two-jet adjustable hand shower, anti-limescale.



SSX541

Miscelatore monocomando per lavello in acciaio inox 316L, bocca con flessibile rivestito in gomma soft-touch nero opaco, doccetta orientabile a due getti, anticalcare.
Single-lever sink mixer in 316L stainless steel, spout with flexible hose covered in matt black soft-touch rubber, two-jet adjustable hand shower, anti-limescale.



SSX84DJ

Miscelatore monocomando per lavello in acciaio inox 316L, con doccetta estraibile a due getti, anticalcare.
Single-lever sink mixer in 316L stainless steel, with two-jet pull-out hand shower, anti-limescale.



X STYLE INOX

WELLNESS INOX

ACCESSORI INOX
INOX ACCESSORIES

CUCINA INOX
INOX KITCHEN



SSX543



A modern bathroom with a large window overlooking a landscape, a shower area, and a swimming pool. The word "WELLNESS" is centered in a white box.

WELLNESS



BOX INCASSO | *BILT-IN BOX*

pag. 332



KIT WELLNESS | *WELLNESS KIT*

pag. 340



CROMOTERAPIA | *COLOR THERAPY*

pag. 356



SOFFIONI | *SHOWER HEADS*

pag. 368



BOCCHIE | *SPOUTS*

pag. 384



PANNELLI DOCCIA | *SHOWER PANELS*

pag. 390



COLONNE DOCCIA | *SHOWER COLUMNS*

pag. 394



SALISCENDI | *SLIDING RAIL*

pag. 424



DOCLETTE | *HANDSHOWER*

pag. 434



SHUT-OFF

pag. 444



BORDO VASCA | *DECK SINK MIXER*

pag. 454



FLESSIBILI DOCCIA | *SHOWER FLEXIBLE*

pag. 458

BOX INCASSO BUILT-IN BOXES

per miscelatore vasca-doccia a 1 o 2 vie.
for 1 or 2-way bath-shower mixer.



- A** Cartuccia Termostatica.
Thermostatic Cartridge.
- B** Cartuccia Ø 40.
Ø 40 Cartridge.
- C** Cartuccia Ø 35.
Ø 35 Cartridge.

Le BOX INCASSO di Remer Rubinetterie sono un articolo studiato appositamente per le esigenze di cantiere.

A differenza delle proposte tradizionali, permettono infatti di incassare una parte murata neutra e compatibile con le diverse collezioni di rubinetteria. In questo modo è possibile concludere i lavori di tracciatura e muratura in totale libertà e senza interruzioni.

Durante i lavori di costruzione sarà necessario definire la BOX a incasso solo in base al numero di uscite d'acqua previste dal progetto.

L'installazione potrà essere completata in un secondo momento con le parti complementari della collezione di rubinetteria che sceglierà il Vostro Cliente.

Ogni BOX INCASSO è infatti predisposta per alloggiare tutte le serie di miscelatori Remer Rubinetterie con:

- A) cartuccia termostatica
- B) cartuccia da 40 mm
- C) cartuccia da 35 mm

Una soluzione versatile, pratica e funzionale che velocizza gli interventi di costruzione, ristrutturazione e manutenzione e che offre ai Vostri Clienti il valore aggiunto della personalizzazione senza impattare sui tempi.

Utilizzando il codice RR BOX (box incasso per miscelatore vasca-doccia a 1 o 2 vie) possono essere gestite tutte le combinazioni che prevedono 1 (o nessuna) deviazione.

Alcune delle possibili combinazioni:

- solo soffione doccia
- soffione doccia + doccetta
- bocca a parete + saliscendi
- bocca per vasca + soffione
- bocca per vasca + doccetta
- soffione + getti doccia

Le BOX INCASSO di REMER Rubinetterie e tutti i loro componenti sono interamente prodotti in Italia utilizzando i migliori materiali e tecnologie produttive high-tech.

La materia prima utilizzata per il contenitore della BOX, ad alta densità, è stata appositamente selezionata per essere pratica al taglio, durevole nel tempo, protettiva, resistente e insonorizzante.

Grazie al ridotto spessore delle BOX di REMER Rubinetterie è possibile l'installazione in cartongessi e pareti in legno. Il prodotto è sempre ispezionabile nel tempo.

BUILT-IN BOX is a Remer Rubinetterie item specifically designed for the construction site needs.

Unlike traditional proposals, BUILT IN BOX allows to house a neutral built-in part compatible with the different faucet collections.

In this way it is possible to complete the building works in total freedom and without interruptions.

During construction work it is necessary to only define the built-in BOX basing on the number of water outlets according to the project.

Faucet installation could be completed at a later time with the complementary parts of the faucet collection that your customer will choose.

Each BUILT-IN BOX is in fact designed to house all the Remer Rubinetterie series of mixers with:

- A) thermostatic cartridge*
- B) 40mm cartridge*
- C) 35mm cartridge*

A versatile, practical and functional solution that speeds up construction, renovation and maintenance interventions and that offers your customers the added value of customization without impacting on time.

Using the RR BOX code (built-in box for 1 or 2-way bath-shower mixer), all the combinations that require 1 (or no) deviation can be managed.

Some of the possible combinations:

- shower head only*
- shower head + hand shower*
- wall spout + sliding rail*
- bath spout + shower head*
- spout for bathtub + hand shower*
- shower head + shower jets*

REMER Rubinetterie BUILT-IN BOXES and all their components are entirely produced in Italy using the best materials and high-tech production technologies.

The high-density raw material used for the BOX container has been specially selected to be practical to cut, long-lasting, protective, resistant and soundproof.

Thanks to the reduced thickness of REMER Rubinetterie BOXES, installation in plasterboard and wooden walls is possible.

The product can always be inspected over time.



Box incasso per miscelatore vasca-doccia a 1 o 2 vie.
Built-in box for 1 or 2-way bath-shower mixer.

Cod. RRBOX

Ø 35: CARTUCCIA - CARTRIDGE

ABSOLUTE	VANITY	ENERGY	INFINITY	DREAM	CLASS LINE	WINNER
AU30KB	V30KB	EY30KB	I30KB	D30KB	L30KB	W30KB
AU09KB	V09KB	EY09KB	I09KB	D09KB	L09KB	W09KB

X STYLE	Q DESIGN	MINIMAL	QUBIKA	REMIX	35
X30KB	Z30KB	N30KB	Q30KB	R30KB	F30KB
X09KB	Z09KB	N09KB	Q09KB	R09KB	F09KB

Ø 40: CARTUCCIA - CARTRIDGE

**CARTUCCIA TERMOSTATICA
THERMOSTATIC CARTRIDGE**



GIGA FOUR	KISS	MINIMAL THERMO	QUBIKA THERMO
G30KB	K30KB	NT30KB	QT30KB
G09KB	K09KB	NT09KB	QT09KB

BOX INCASSO
BUILT-IN BOX

KIT WELLNESS
WELLNESS KIT

CROMOTERAPIA
COLOR THERAPY

SOFFIONI
SHOWER HEADS

BOCCHE
SPOUTS

PANNELLI DOCCIA
SHOWER PANELS

COLONNE DOCCIA
SHOWER COLUMNS

SALISCENDI
SLIDING RAILS

DOCETTE
HAND SHOWERS

SHUT-OFF

BORDO VASCA
DECK BATH MIXER

FLESSIBILI DOCCIA
SHOWER FLEXIBLES

BOX INCASSO BUILT-IN BOXES

per miscelatore vasca-doccia con deviatore a dischi ceramici, 2 vie e 2 posizioni.
for 2-way and 2-position ceramic disc bath-shower mixer.



Le BOX INCASSO di Remer Rubinetterie sono un articolo studiato appositamente per le esigenze di cantiere.

A differenza delle proposte tradizionali, permettono infatti di incassare una parte murata neutra e compatibile con le diverse collezioni di rubinetteria.

In questo modo è possibile concludere i lavori di tracciatura e muratura in totale libertà e senza interruzioni.

Durante i lavori di costruzione sarà necessario definire la BOX a incasso solo in base al numero di uscite d'acqua previste dal progetto.

L'installazione potrà essere completata in un secondo momento con le parti complementari della collezione di rubinetteria che sceglierà il Vostro Cliente.

Ogni BOX INCASSO è infatti predisposta per alloggiare tutte le serie di miscelatori Remer Rubinetterie con:

- A) cartuccia termostatica
- B) cartuccia da 40 mm
- C) cartuccia da 35 mm

Una soluzione versatile, pratica e funzionale che velocizza gli interventi di costruzione, ristrutturazione e manutenzione e che offre ai Vostri Clienti il valore aggiunto della personalizzazione senza impattare sui tempi.

Utilizzando il codice RR BOX 92 (box incasso per miscelatore vasca-doccia con deviatore a 2 vie e 2 posizioni) possono essere gestite le tutte le combinazioni a due uscite.

Alcune delle possibili combinazioni:

- soffione doccia + doccetta
- bocca a parete + saliscendi
- bocca per vasca + soffione
- bocca per vasca + doccetta
- soffione + getti doccia

Le BOX INCASSO di REMER Rubinetterie e tutti i loro componenti sono interamente prodotti in Italia utilizzando i migliori materiali e tecnologie produttive high-tech.

La materia prima utilizzata per il contenitore della BOX, ad alta densità, è stata appositamente selezionata per essere pratica al taglio, durevole nel tempo, protettiva, resistente e insonorizzante.

Grazie al ridotto spessore delle BOX di REMER Rubinetterie è possibile l'installazione in cartongessi e pareti in legno.

Il prodotto è sempre ispezionabile nel tempo.

BUILT-IN BOX is a Remer Rubinetterie item specifically designed for the construction site needs.

Unlike traditional proposals, BUILT IN BOX allows to house a neutral built-in part compatible with the different faucet collections.

In this way it is possible to complete the building works in total freedom and without interruptions.

During construction work it is necessary to only define the built-in BOX basing on the number of water outlets according to the project.

Faucet installation could be completed at a later time with the complementary parts of the faucet collection that your customer will choose.

Each BUILT-IN BOX is in fact designed to house all the Remer Rubinetterie series of mixers with:

- A) thermostatic cartridge*
- B) 40mm cartridge*
- C) 35mm cartridge*

A versatile, practical and functional solution that speeds up construction, renovation and maintenance interventions and that offers your customers the added value of customization without impacting on time.

Using the code RR BOX 92 (built-in box for bath-shower mixer with 2-way and 2-position diverter) all the two-outlet combinations can be managed.

Some of the possible combinations:

- shower head + hand shower*
- shower head + sliding rail*
- bathtub spout + shower head*
- bathtub spout + hand shower*
- shower head + shower jets*

REMER Rubinetterie BUILT-IN BOXES and all their components are entirely produced in Italy using the best materials and high-tech production technologies.

The high-density raw material used for the BOX container has been specially selected to be practical to cut, long-lasting, protective, resistant and soundproof.

Thanks to the reduced thickness of REMER Rubinetterie BOXES, installation in plasterboard and wooden walls is possible.

The product can always be inspected over time.



Box incasso per miscelatore vasca-doccia a dischi ceramici, a 2 vie e 2 posizioni.
Built-in box for 2-way and 2-position ceramic disc bath-shower mixer.

Cod. RRBOX92

INCASSI CON RR BOX 92 - BUILT-IN WITH RR BOX 92



<p>ABSOLUTE</p> <p>AU92KB</p>	<p>VANITY</p> <p>V92KB</p>	<p>ENERGY</p> <p>EY92KB</p>	<p>INFINITY</p> <p>I92KB</p>	<p>DREAM</p> <p>D92KB</p>
<p>CLASS LINE</p> <p>L92KB</p>	<p>WINNER</p> <p>W92KB</p>	<p>X STYLE</p> <p>X92KB</p>	<p>Q DESIGN</p> <p>Z92KB</p>	<p>MINIMAL</p> <p>N92KB</p>
<p>QUBIKA</p> <p>Q92KB</p>	<p>ELEGANCE</p> <p>NT92KB</p>	<p>Q-ELEGANCE</p> <p>QT92KB</p>		

BOX INCASSO
BUILT-IN BOX

KIT WELLNESS
WELLNESS KIT

CROMOTERAPIA
COLOR THERAPY

SOFFIONI
SHOWER HEADS

BOCCHE
SPOUTS

PANNELLI DOCCIA
SHOWER PANELS

COLONNE DOCCIA
SHOWER COLUMNS

SALISCENDI
SLIDING RAILS

DOCCETTE
HAND SHOWERS

SHUT-OFF

BORDO VASCA
DECK BATH MIXER

FLESSIBILI DOCCIA
SHOWER FLEXIBLES

BOX INCASSO BUILT-IN BOXES

per miscelatore vasca-doccia con
deviatore a dischi ceramici a 3 vie.
for 3-way ceramic disc bath-shower mixer.



Le BOX INCASSO di Remer Rubinetterie sono un articolo studiato appositamente per le esigenze di cantiere.

A differenza delle proposte tradizionali, permettono infatti di incassare una parte murata neutra e compatibile con le diverse collezioni di rubinetteria.

In questo modo è possibile concludere i lavori di tracciatura e muratura in totale libertà e senza interruzioni.

Durante i lavori di costruzione sarà necessario definire la BOX a incasso solo in base al numero di uscite d'acqua previste dal progetto.

L'installazione potrà essere completata in un secondo momento con le parti complementari della collezione di rubinetteria che sceglierà il Vostro Cliente.

Ogni BOX INCASSO è infatti predisposta per alloggiare tutte le serie di miscelatori Remer Rubinetterie con:

- A) cartuccia termostatica
- B) cartuccia da 40 mm
- C) cartuccia da 35 mm

Una soluzione versatile, pratica e funzionale che velocizza gli interventi di costruzione, ristrutturazione e manutenzione e che offre ai Vostri Clienti il valore aggiunto della personalizzazione senza impattare sui tempi.

Utilizzando il codice RR BOX 93 (box incasso per miscelatore vasca-doccia con deviatore a 3 vie) possono essere gestite le tutte le combinazioni a tre uscite. Alcune delle possibili combinazioni:

- saliscendi + soffione con getto pioggia e getto cascata
- doccetta + soffione con getto pioggia e getto cascata
- bocca a parete + saliscendi + soffione
- soffione doccia + getti doccia + doccetta

Le BOX INCASSO di REMER Rubinetterie e tutti i loro componenti sono interamente prodotti in Italia utilizzando i migliori materiali e tecnologie produttive high-tech.

La materia prima utilizzata per il contenitore della BOX, ad alta densità, è stata appositamente selezionata per essere pratica al taglio, durevole nel tempo, protettiva, resistente e insonorizzante.

Grazie al ridotto spessore delle BOX di REMER Rubinetterie è possibile l'installazione in cartongessi e pareti in legno.

Il prodotto è sempre ispezionabile nel tempo.

BUILT-IN BOX is a Remer Rubinetterie item specifically designed for the construction site needs.

Unlike traditional proposals, BUILT IN BOX allows to house a neutral built-in part compatible with the different faucet collections.

In this way it is possible to complete the building works in total freedom and without interruptions.

During construction work it is necessary to only define the built-in BOX basing on the number of water outlets according to the project.

Faucet installation could be completed at a later time with the complementary parts of the faucet collection that your customer will choose.

Each BUILT-IN BOX is in fact designed to house all the Remer Rubinetterie series of mixers with:

- A) thermostatic cartridge*
- B) 40mm cartridge*
- C) 35mm cartridge*

A versatile, practical and functional solution that speeds up construction, renovation and maintenance interventions and that offers your customers the added value of customization without impacting on time.

Using the code RR BOX 93 (built-in box for bath-shower mixer with 3-way diverter) all the combinations with three outputs can be managed.

Some of the possible combinations:

- sliding rail + shower head with rain jet and waterfall jet*
- hand shower + shower head with rain and waterfall jet*
- wall mounted spout + sliding rail + shower head*
- shower head + shower jets + hand shower*

REMER Rubinetterie BUILT-IN BOXES and all their components are entirely produced in Italy using the best materials and high-tech production technologies.

The high-density raw material used for the BOX container has been specially selected to be practical to cut, long-lasting, protective, resistant and soundproof.

Thanks to the reduced thickness of REMER Rubinetterie BOXES, installation in plasterboard and wooden walls is possible.

The product can always be inspected over time.



Box incasso per miscelatore vasca-doccia a dischi ceramici, a 3 vie e 3 posizioni.
 Built-in box for 3-way ceramic disc bath-shower mixer.

Cod. RRBOX93

INCASSI CON RR BOX 93 - BUILT-IN WITH RR BOX 93



<p>ABSOLUTE</p> <p>AU93KB</p> <p>AU937KB</p>	<p>VANITY</p> <p>V93KB</p> <p>V937KB</p>	<p>ENERGY</p> <p>EY93KB</p> <p>EY937KB</p>	<p>INFINITY</p> <p>I93KB</p> <p>I937KB</p>	<p>DREAM</p> <p>D93KB</p> <p>D937KB</p>
<p>CLASS LINE</p> <p>L93KB</p> <p>L937KB</p>	<p>WINNER</p> <p>W93KB</p> <p>W937KB</p>	<p>X STYLE</p> <p>X93KB</p> <p>X937KB</p>	<p>Q DESIGN</p> <p>Z93KB</p> <p>Z937KB</p>	<p>MINIMAL</p> <p>N93KB</p> <p>N937KB</p>
<p>QUBIKA</p> <p>Q93KB</p> <p>Q937KB</p>	<p>ELEGANCE</p> <p>NT93KB</p> <p>NT937KB</p>	<p>Q-ELEGANCE</p> <p>QT93KB</p> <p>QT937KB</p>		

- BOX INCASSO
BUILT-IN BOX
- KIT WELLNESS
WELLNESS KIT
- CROMOTERAPIA
COLOR THERAPY
- SOFFIONI
SHOWER HEADS
- BOCCHE
SPOUTS
- PANNELLI DOCCIA
SHOWER PANELS
- COLONNE DOCCIA
SHOWER COLUMNS
- SALISCENDI
SLIDING RAILS
- DOCETTE
HAND SHOWERS
- SHUT-OFF
- BORDO VASCA
DECK BATH MIXER
- FLESSIBILI DOCCIA
SHOWER FLEXIBLES

BOX INCASSO BUILT-IN BOXES

per miscelatore lavabo a muro.
for wall mounted wash basin mixer.



Le BOX INCASSO di Remer Rubinetterie sono un articolo studiato appositamente per le esigenze di cantiere.

A differenza delle proposte tradizionali, permettono infatti di incassare una parte murata neutra e compatibile con le diverse collezioni di rubinetteria.

In questo modo è possibile concludere i lavori di tracciatura e muratura in totale libertà e senza interruzioni.

L'installazione della rubinetteria potrà essere completata in un secondo momento con le parti complementari della collezione che sceglierà il Vostro Cliente.

Ogni BOX INCASSO è infatti predisposta per alloggiare tutte le serie di miscelatori Remer Rubinetterie con:

- A) cartuccia termostatica
- B) cartuccia da 40 mm
- C) cartuccia da 35 mm

Il codice RRBOX15 (box incasso per miscelatore lavabo a muro) è predisposto per alloggiare tutti i modelli di miscelatore per lavabo a muro delle collezioni Remer Rubinetterie.

Una soluzione versatile, pratica e funzionale che velocizza gli interventi di costruzione, ristrutturazione e manutenzione e che offre ai Vostri Clienti il valore aggiunto della personalizzazione senza impattare sui tempi e sullo stato dei lavori.

Le BOX INCASSO di REMER Rubinetterie e tutti i loro componenti sono interamente prodotti in Italia utilizzando i migliori materiali e tecnologie produttive high-tech.

La materia prima utilizzata per il contenitore della BOX, ad alta densità, è stata appositamente selezionata per essere pratica al taglio, durevole nel tempo, protettiva, resistente e insonorizzante.

Grazie al ridotto spessore delle BOX di REMER Rubinetterie è possibile l'installazione in cartongessi e pareti in legno.

Il prodotto è sempre ispezionabile nel tempo.

BUILT-IN BOX is a Remer Rubinetterie item specifically designed for the construction site needs.

Unlike traditional proposals, BUILT_IN BOX allows to house a neutral built-in part compatible with the different faucet collections.

In this way it is possible to complete the building works in total freedom and without interruptions.

Faucet installation could be completed at a later time with the complementary parts of the faucet collection that your customer will choose.

Each BUILT-IN BOX is in fact designed to house all the Remer Rubinetterie series of mixers with:

- A) thermostatic cartridge*
- B) 40mm cartridge*
- C) 35mm cartridge*

The code RRBOX15 (built-in box for wall-mounted basin mixer) is designed to house all the wall-mounted basin mixer models of the Remer Rubinetterie collections.

A versatile, practical and functional solution that speeds up construction, renovation and maintenance interventions and that offers your customers the added value of customization without impacting the time and state of the work.

REMER Rubinetterie BUILT-IN BOXES and all their components are entirely produced in Italy using the best materials and high-tech production technologies.

The high-density raw material used for the BOX container has been specially selected to be practical to cut, long-lasting, protective, resistant and soundproof.

Thanks to the reduced thickness of REMER Rubinetterie BOXES, installation in plasterboard and wooden walls is possible.

The product can always be inspected over time.



Box da incasso per miscelatore lavabo a muro.
Built-in box for wall mounted wash basin mixer.

Cod. RRBOX15

INCASSI CON RR BOX 15 - BUILT-IN WITH RR BOX 15

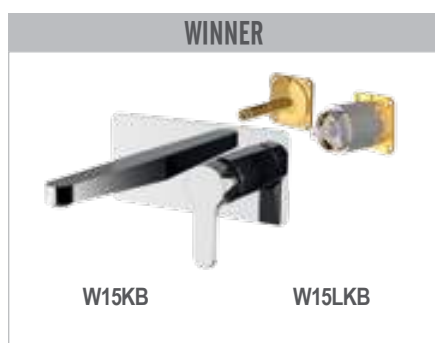
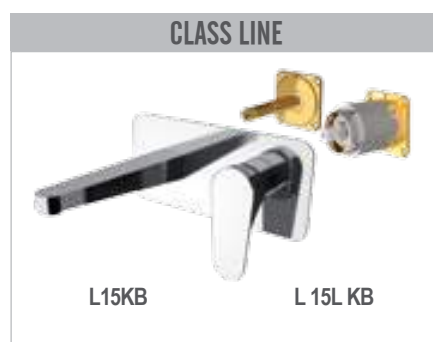
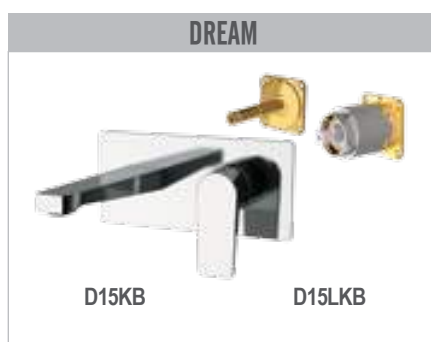
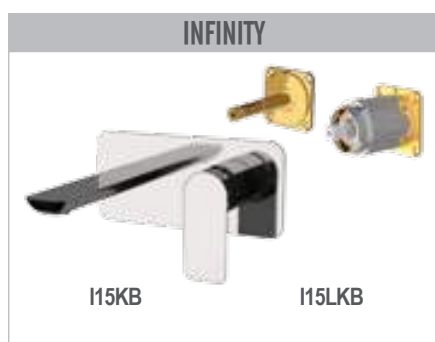
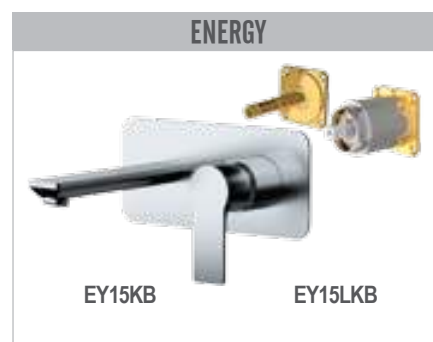
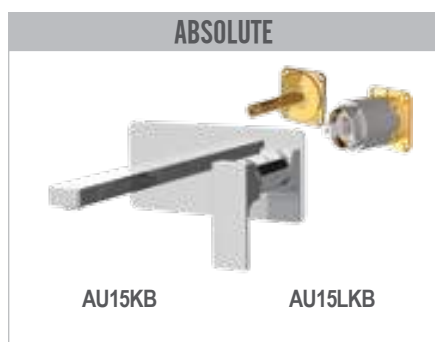

BOX INCASSO
BUILT-IN BOX

KIT WELLNESS
WELLNESS KIT

CROMOTERAPIA
COLOR THERAPY

SOFFIONI
SHOWER HEADS

BOCCHE
SPOUTS

PANNELLI DOCCIA
SHOWER PANELS

COLONNE DOCCIA
SHOWER COLUMNS

SALISCENDI
SLIDING RAILS

DOCETTE
HAND SHOWERS

SHUT-OFF

BORDO VASCA
DECK BATH MIXER

FLESSIBILI DOCCIA
SHOWER FLEXIBLES

KIT WELLNESS WELLNESS KIT



I KIT WELLNESS di Remer Rubinetterie sono soluzioni complete di rubinetteria studiate per arredare gli interni doccia. Le composizioni doccia si differenziano per miscelazione tradizionale o termostatica oltre che per forme, dimensioni, funzioni e numero di uscite acqua gestite. E' così possibile personalizzare ogni bagno progettando un interno doccia a misura delle singole preferenze.

WELLNESS KITS by Remer Rubinetterie are complete faucet solutions designed to furnish shower interiors. The shower compositions differ in traditional or thermostatic mixing as well as in shapes, dimensions, functions and number of managed water outlets. It is thus possible to customize each bathroom by designing a shower interior tailored to individual preferences.



BOX INCASSO
BUILT-IN BOX

KIT WELLNESS
WELLNESS KIT

CROMOTERAPIA
COLOR THERAPY

SOFFIONI
SHOWER HEADS

BOCCHE
SPOUTS

PANNELLI DOCCIA
SHOWER PANELS

COLONNE DOCCIA
SHOWER COLUMNS

SALISCENDI
SLIDING RAILS

DOCETTE
HAND SHOWERS

SHUT-OFF

BORDO VASCA
DECK BATH MIXER

FLESSIBILI DOCCIA
SHOWER FLEXIBLES

VARIANTI FLESSIBILE - FLEXIBLE HOSES VARIANTS

Per richiedere la variante flessibile aggiungere la lettera al codice articolo.

To request the flexible variant, add the letter to the article number.



332CNMTR150

Flessibile doccia retinato realizzato in PVC atossico con attacco conico.

Flexible hose for shower with net working metal colour in atoxic PVC with one conical nut.



M

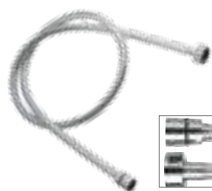

332CNBC150

Flessibile doccia in PVC atossico con piastrina cromata, attacco conico.

Flexible hose for shower in atoxic PVC and chrome flat wire, with one conical nut.



C

KIT DOCCIA SENZA MISCELATORE - SHOWER KIT WITHOUT SHOWER MIXE



30 cm



Set doccia composto da: soffione in acciaio inox 357UFM20X, braccio in ottone 30 cm, presa acqua a muro con supporto doccetta, doccetta in abs, 1 funzione 317MD, flessibile 150 cm.

Shower set including: stainless steel shower head 357UFM20X, brass arm 30 cm, wall water connection with shower holder, 1-function abs hand shower 317MD, 150 cm flexible hose.

SETS02D20

con soffione ultrapiatto Ø 20 cm
with ultraslim d shower head Ø 20 cm.

SETS02D25

con soffione ultrapiatto Ø 25 cm.
with ultraslim shower head Ø 25 cm.

SETS02D30

con soffione ultrapiatto Ø 30 cm.
with ultraslim shower head Ø 30 cm.



30 cm



Set doccia composto da: soffione in abs 356MD20X, braccio in ottone 30 cm, presa acqua a muro con supporto doccetta, doccetta in abs, 1 funzione 317MD, flessibile 150 cm.

Shower set including: abs shower head 356MD20X, brass arm 30 cm, wall water connection with shower holder, 1-function abs hand shower 317MD, 150 cm flexible hose.

SETS02MD20

con soffione Ø 20 cm
with shower head Ø 20 cm.

SETS02MD25

con soffione Ø 25 cm.
with shower head Ø 25 cm.

SETS02MD30

con soffione Ø 30 cm.
with shower head Ø 30 cm.



30 cm



Set doccia composto da: soffione in acciaio inox 357UFS20X, braccio quadrato in ottone 30 cm, presa acqua a muro con supporto doccetta, doccetta in abs a 1 funzione 317SQ, flessibile 150 cm.

Shower set including: stainless steel 20x20cm shower head 357UFS20X, square brass arm 30 cm, wall water connection with shower holder, 1-function abs hand shower 317SQ, 150 cm flexible hose.

SETS02Q20Q

con soffione ultrapiatto 20x20 cm.
with ultraslim shower head 20x20 cm.

SETS02Q25Q

con soffione ultrapiatto 25x25 cm.
with ultraslim shower head 25x25 cm.

SETS02Q30Q

con soffione ultrapiatto 30x30 cm.
with ultraslim shower head 30x30 cm.



30 cm



Set doccia composto da: soffione in abs 356SD20X, braccio quadrato in ottone 30 cm, presa acqua a muro con supporto doccetta, doccetta quadrata in ABS, 1 funzione 317SD, flessibile 150 cm.

Shower set including: abs shower head 356SD20X, square brass arm 30 cm, wall water connection with shower holder, 1-function abs square hand shower 317SD, 150 cm flexible hose.

SETS02SD20

con soffione 20x20 cm.
with shower head 20x20 cm.

SETS02SD25

con soffione 25x25 cm.
with shower head 25x25 cm.

SETS02SD30

con soffione 30x30 cm.
with shower head 30x30 cm.



**SETS028MPL30EC20**

Set doccia composto da: soffione in abs Ø 20cm 354EC20X, braccio in ottone 30 cm, presa acqua a muro con supporto doccetta, doccetta in abs con 4 funzioni 318MP, flessibile 150 cm.

Shower set including: abs Ø 20 cm shower head 354EC20X, brass arm 30 cm, wall water connection with shower holder, 4-function abs hand shower 318MP, 150 cm flexible hose.

**SETS02AD20Q**

Set doccia composto da: soffione in abs 20x20cm con angoli arrotondati 356AD20X, braccio in ottone 30 cm, presa acqua a muro con supporto doccetta, doccetta in abs con 4 funzioni 318CP, flessibile 150 cm.

Shower set including: abs 20x20 cm shower head with rounded corners 356AD20X, brass arm 30 cm, wall water connection with shower holder, 4-function abs hand shower 318CP, 150 cm flexible hose.



Set doccia composto da: soffione in acciaio inox con angoli arrotondati 357UFD20X, braccio in ottone 30 cm, presa acqua a muro con supporto doccetta, doccetta in abs con 4 funzioni 318CP, flessibile 150 cm.

Shower set including: stainless steel shower head with rounded corners 357UFD20X, brass arm 30 cm, wall water connection with shower holder, 4-function abs hand shower 318CP, 150 cm flexible hose.

SETS02UFD20Q

con soffione ultrapiatto con angoli arrotondati 20x20 cm.

with ultraslim shower head with rounded corners 20x20 cm.

**SETS02UFD25Q**

con soffione ultrapiatto con angoli arrotondati 25x25 cm.

with ultraslim shower head 25x25 cm with rounded corners.

SETS02UFD30Q

con soffione ultrapiatto con angoli arrotondati 30x30 cm.

with ultraslim shower head with rounded corners 30x30 cm.

**SETS028CPL30EC20**

Set doccia composto da: soffione in abs Ø 20cm 354EC20X, braccio in ottone 30 cm, presa acqua a muro con supporto doccetta, doccetta in abs con 4 funzioni 318CP, flessibile 150 cm.

Shower set including: abs Ø 20 cm shower head 354EC20X, brass arm 30 cm, wall water connection with shower holder, 4-function abs hand shower 318CP, 150 cm flexible hose.

**SETS02SS**

Set doccia composto da: soffione a parete in acciaio inox con getto a pioggia 350SSX, presa acqua a muro con supporto doccetta, doccetta quadrata in ABS, 1 funzione 317SD, flessibile 150 cm.

Shower set including: wall-mounted stainless steel shower head with rain jet 350SSX, wall water connection with shower holder, 1-function abs square hand shower 317SD, 150 cm flexible hose.

**SETS02UF**

Set doccia composto da: soffione a parete in acciaio inox con getto a pioggia 350UFX, presa acqua a muro con supporto doccetta, doccetta piatta in ottone a 1 funzione 317RR, flessibile 150 cm.

Shower set including: wall-mounted stainless steel shower head with rain jet 350UFX, wall water connection with shower holder, 1-function brass flat hand shower 317RR, 150 cm flexible hose.

**SETS02UFM**

Set doccia composto da: soffione a parete in acciaio inox con getto a pioggia 350UFMX, presa acqua a muro con supporto doccetta, doccetta in abs, 1 funzione 317MD, flessibile 150 cm.

Shower set including: wall-mounted stainless steel shower head with rain jet 350UFMX, wall water connection with shower holder, 1-function abs hand shower 317MD, 150 cm flexible hose.

BOX INCASSO
BUILT-IN BOXKIT WELLNESS
WELLNESS KITCROMOTERAPIA
COLOR THERAPYSOFFIONI
SHOWER HEADSBOCCHE
SPOUTSPANNELLI DOCCIA
SHOWER PANELSCOLONNE DOCCIA
SHOWER COLUMNSSALISCENDI
SLIDING RAILSDOCCETTE
HAND SHOWERS

SHUT-OFF

BORDO VASCA
DECK BATH MIXERFLESSIBILI DOCCIA
SHOWER FLEXIBLES

PER MISCELATORI A INCASSO A 3 VIE - FOR 3-WAY BUILT IN MIXER



SETS02SSCA

Set doccia composto da: soffione a parete in acciaio inox con getto a pioggia e cascata 350SSCAX, presa acqua a muro con supporto doccetta, doccetta quadrata in ABS, 1 funzione 317SD, flessibile 150 cm.
Shower set including: wall mounted stainless steel shower head with rain and waterfall functions 350SSCAX, wall water connection with shower holder, 1-function abs square hand shower 317SD, 150 cm flexible hose.



SETS02UFCA

Set doccia composto da: soffione a parete in acciaio inox con getto a pioggia e cascata 350UFCA, presa acqua a muro con supporto doccetta, doccetta piatta in ottone a 1 funzione 317RR, flessibile 150 cm.
Shower set including: wall mounted stainless steel shower head with rain and waterfall functions 350UFCA, wall water connection with shower holder, 1-function brass flat hand shower 317RR, 150 cm flexible hose.



SETS02UFMCA

Set doccia composto da: soffione a parete in acciaio inox con getto a pioggia e cascata 350UFMCA, presa acqua a muro con supporto doccetta, doccetta in abs, 1 funzione 317MD, flessibile 150 cm.
Shower set including: wall mounted stainless steel shower head with rain and waterfall functions 350UFMCA, wall water connection with shower holder, 1-function abs hand shower 317MD, 150 cm flexible hose.





SETS02SSCA

BOX INCASSO
BUILT-IN BOX

KIT WELLNESS
WELLNESS KIT

CROMOTERAPIA
COLOR THERAPY

SOFFIONI
SHOWER HEADS

BOCCHE
SPOUTS

PANNELLI DOCCIA
SHOWER PANELS

COLONNE DOCCIA
SHOWER COLUMNS

SALISCENDI
SLIDING RAILS

DOCETTE
HAND SHOWERS

SHUT-OFF

BORDO VASCA
DECK BATH MIXER

FLESSIBILI DOCCIA
SHOWER FLEXIBLES

KIT WELLNESS QUADRATI



Set doccia composto da: miscelatore a incasso con deviatore, soffione in abs 356SD20X, braccio quadrato in ottone 30 cm, saliscendi quadrato in ottone 317S, presa acqua a muro, doccetta quadrata in ABS, 1 funzione 317SD, flessibile 150 cm.
 Shower set including: built-in mixer with diverter, abs shower head 356SD20X, square brass arm 30 cm, square brass sliding rail 317S, wall water connection, 1-function abs square hand shower 317SD, 150 cm flexible hose.



AU09S01SD20

Con soffione da 20x20 cm e braccio a parete 30 cm.
 With shower head 20x20 cm and wall arm 30 cm.

AU09S01SD25

Con soffione da 25x25 cm e braccio a parete 30 cm.
 With shower head 25x25 cm and wall arm 30 cm.

AU09S01SD30

Con soffione da 30x30 cm e braccio a parete 30 cm.
 With shower head 30x30 cm and wall arm 30 cm.

AU09S21SD20

Con soffione da 20x20 cm e braccio a soffitto da 30 cm.
 With shower head 20x20 cm and ceiling arm 30 cm.

SQUARED WELLNESS KIT



Set doccia composto da: miscelatore a incasso con deviatore, soffione in abs 356SD20X, braccio quadrato in ottone 30 cm, presa acqua a muro con supporto doccetta, doccetta quadrata in ABS, 1 funzione 317SD, flessibile 150 cm.
 Shower set including: built-in mixer with diverter, abs shower head 356SD20X, square brass arm 30 cm, wall water connection with shower holder, 1-function abs square hand shower 317SD, 150 cm flexible hose.



AU09S02SD20

Con soffione da 20x20 cm e braccio a parete 30 cm.
 With shower head 20x20 cm and wall arm 30 cm.

AU09S02SD25

Con soffione da 25x25 cm e braccio a parete 30 cm.
 With shower head 25x25 cm and wall arm 30 cm.

AU09S02SD30

Con soffione da 30x30 cm e braccio a parete 30 cm.
 With shower head 30x30 cm and wall arm 30 cm.

AU09S22SD20

Con soffione da 20x20 cm e braccio a soffitto da 30 cm.
 With shower head 20x20 cm and ceiling arm 30 cm.



Set doccia composto da: miscelatore a incasso con deviatore, soffione in acciaio inox 357UFS20X, braccio quadrato in ottone 30 cm, saliscendi quadrato in ottone 317S, presa acqua a muro, doccetta quadrata in ABS, 1 funzione 317SD, flessibile 150 cm.
 Shower set including: built-in mixer with diverter, stainless steel shower head 357UFS20X, square brass arm 30 cm, square brass sliding rail 317S, wall water connection, 1-function abs square hand shower 317SD, 150 cm flexible hose.



AU09S01UFS20

Con soffione da 20x20 cm e braccio a parete 30 cm.
 With shower head 20x20 cm and wall arm 30 cm.

AU09S01UFS25

Con soffione da 25x25 cm e braccio a parete 30 cm.
 With shower head 25x25 cm and wall arm 30 cm.

AU09S01UFS30

Con soffione da 30x30 cm e braccio a parete 30 cm.
 With shower head 30x30 cm and wall arm 30 cm.

AU09S21UFS20

Con soffione da 20x20 cm e braccio a soffitto da 30 cm.
 With shower head 20x20 cm and ceiling arm 30 cm.



Set doccia composto da: miscelatore a incasso con deviatore, soffione in acciaio inox 357UFS20X, braccio quadrato in ottone 30 cm, presa acqua a muro con supporto doccetta, doccetta quadrata in ABS, 1 funzione 317SD, flessibile 150 cm.
 Shower set including: built-in mixer with diverter, stainless steel shower head 357UFS20X, square brass arm 30 cm, wall water connection with shower holder, 1-function abs square hand shower 317SD, 150 cm flexible hose.



AU09S02UFS20

Con soffione da 20x20 cm e braccio a parete 30 cm.
 With shower head 20x20 cm and wall arm 30 cm.

AU09S02UFS25

Con soffione da 25x25 cm e braccio a parete 30 cm.
 With shower head 25x25 cm and wall arm 30 cm.

AU09S02UFS30

Con soffione da 30x30 cm e braccio a parete 30 cm.
 With shower head 30x30 cm and wall arm 30 cm.

AU09S22UFS20

Con soffione da 20x20 cm e braccio a soffitto da 30 cm.
 With shower head 20x20 cm and ceiling arm 30 cm.

BOX INCASSO
BUILT-IN BOXKIT WELLNESS
WELLNESS KITCROMOTERAPIA
COLOR THERAPYSOFFIONI
SHOWER HEADSBOCCHE
SPOUTSPANNELLI DOCCIA
SHOWER PANELSCOLONNE DOCCIA
SHOWER COLUMNSSALISCENDI
SLIDING RAILSDOCCETTE
HAND SHOWERS

SHUT-OFF

BORDO VASCA
DECK BATH MIXERFLESSIBILI DOCCIA
SHOWER FLEXIBLES**AU09S01SS**

Set doccia composto da: miscelatore a incasso con deviatore, soffione a parete in acciaio inox con getto a pioggia 350SSX, saliscendi quadrato in ottone 317S, presa acqua a muro, doccetta quadrata in ABS, 1 funzione 317SD, flessibile 150 cm.
 Shower set including: built-in mixer with diverter, wall-mounted stainless steel shower head with rain jet 350SSX, square brass sliding rail 317S, wall water connection, 1-function abs square hand shower 317SD, 150 cm flexible hose.

**AU09S02SS**

Set doccia composto da: miscelatore a incasso con deviatore, soffione a parete in acciaio inox con getto a pioggia 350SSX, presa acqua a muro con supporto doccetta, doccetta quadrata in ABS, 1 funzione 317SD, flessibile 150 cm.
 Shower set including: built-in mixer with diverter, wall-mounted stainless steel shower head with rain jet 350SSX, wall water connection with shower holder, 1-function abs square hand shower 317SD, 150 cm flexible hose.



CON OPZIONI DI FINITURA WITH FINISHING OPTIONS

30 cm



AU09S01O20

Set doccia composto da: miscelatore a incasso con deviatore, soffione in ottone 20x20cm 359SSX, braccio quadrato in ottone 30 cm, saliscendi quadrato in ottone 317S, presa acqua a muro, doccetta quadrata in ottone a 1 funzione 317SS, flessibile 150 cm.

Shower set including: built-in mixer with diverter, brass shower head 20x20cm 359SSX, square brass arm 30 cm, square brass sliding rail 317S, wall water connection, 1-function brass square hand shower 317SS, 150 cm flexible hose.

30 cm



AU09S02O20

Set doccia composto da: miscelatore a incasso con deviatore, soffione in ottone 20x20cm 359SSX, braccio quadrato in ottone 30 cm, presa acqua a muro con supporto doccetta, doccetta quadrata in ottone a 1 funzione 317SS, flessibile 150 cm.

Shower set including: built-in mixer with diverter, brass shower head 20x20cm 359SSX, square brass arm 30 cm, wall water connection with shower holder, 1-function brass square hand shower 317SS, 150 cm flexible hose.

AU09S01O30

con soffione da 30x30 cm.
with shower head 30x30 cm.

AU09S02O30

con soffione da 30x30 cm.
with shower head 30x30 cm.



FIN 1

NO

BO

NP

NPO

FIN 2

CFP

BG

DO

50 cm



AU93S01SSCA

Set doccia composto da: miscelatore a incasso con deviatore a 3 vie, soffione a parete in acciaio inox con getto a pioggia e cascata 350SSCAX, saliscendi quadrato in ottone 317S, presa acqua a muro, doccetta quadrata in ottone a 1 funzione 317SS, flessibile 150 cm.

Shower set including: built-in mixer with 3-way diverter, wall mounted stainless steel shower head with rain and waterfall functions 350SSCAX, square brass sliding rail 317S, wall water connection, 1-function brass square hand shower 317SS, 150 cm flexible hose.

50 cm



AU93S02SSCA

Set doccia composto da: miscelatore a incasso con deviatore a 3 vie, soffione a parete in acciaio inox con getto a pioggia e cascata 350SSCAX, presa acqua a muro con supporto doccetta, doccetta quadrata in ottone a 1 funzione 317SS, flessibile 150 cm.

Shower set including: built-in mixer with 3-way diverter, wall mounted stainless steel shower head with rain and waterfall functions 350SSCAX, wall water connection with shower holder, 1-function brass square hand shower 317SS, 150 cm flexible hose.



AU93S01UFCA

Come AU 93 S01 SSCA ma con soffione doccia ultrapiatto a parete in acciaio inox lucidato a specchio 2 getti, normale o cascata.

As AU 93 S01 SSCA but with ultra slim stainless steel mirror polished wall shower head 2 jets, normal and waterfall.

AU93S02UFCA

Come AU 93 S02 SSCA ma con soffione doccia ultrapiatto a parete in acciaio inox lucidato a specchio 2 getti, normale o cascata.

As AU 93 S02 SSCA but with ultra slim stainless steel mirror polished wall shower head 2 jets, normal and waterfall.





Set doccia composto da: miscelatore a incasso con deviatore a 3 vie, soffione in acciaio inox 357UFS20X, braccio quadrato in ottone 30 cm, saliscendi quadrato in ottone 317S, presa acqua a muro, doccetta quadrata in ottone a 1 funzione 317SS, 6 getti quadrati, flessibile 150 cm.

Shower set including: built-in mixer with 3-way diverter, stainless steel shower head 357UFS20X, square brass arm 30 cm, square brass sliding rail 317S, wall water connection, 1-function brass square hand shower 317SS, 6 square body jets, 150 cm flexible hose.



AU93S01UFS20

con soffione da 20x20 cm e braccio a parete 30 cm.
with shower head 20x20 cm and wall arm 30 cm.

AU93S01UFS25

con soffione da 25x25 cm e braccio a parete 30 cm.
with shower head 25x25 cm and wall arm 30 cm.

AU93S01UFS30

con soffione da 30x30 cm e braccio a parete 30 cm.
with shower head 30x30 cm and wall arm 30 cm.

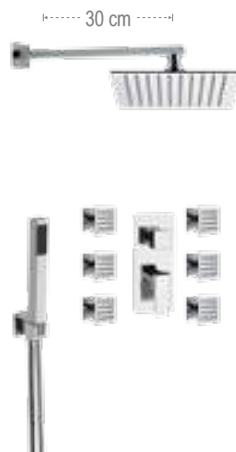

Set doccia composto da: miscelatore a incasso con deviatore a 3 vie, soffione in acciaio inox 357UFS20X, braccio quadrato in ottone 30 cm, presa acqua a muro con supporto doccetta, doccetta quadrata in ottone a 1 funzione 317SS, 6 getti quadrati, flessibile 150 cm.

Shower set including: built-in mixer with 3-way diverter, stainless steel shower head 357UFS20X, square brass arm 30 cm, wall water connection with shower holder, 1-function brass square hand shower 317SS, 6 square body jets, 150 cm flexible hose.



AU93S02UFS20

con soffione da 20x20 cm e braccio a parete 30 cm.
with shower head 20x20 cm and wall arm 30 cm.

AU93S02UFS25

con soffione da 25x25 cm e braccio a parete 30 cm.
with shower head 25x25 cm and wall arm 30 cm.

AU93S02UFS30

con soffione da 30x30 cm e braccio a parete 30 cm.
with shower head 30x30 cm and wall arm 30 cm.



AU93S01SS

Con soffione doccia a parete in acciaio inox lucidato a specchio.
With stainless steel mirror polished wall shower head.



AU93S02SS

Con soffione doccia a parete in acciaio inox lucidato a specchio.
With stainless steel mirror polished wall shower head.

CON SOFFIONI A SOFFITTO - CEILING SHOWER HEAD



Set doccia composto da: miscelatore a incasso con deviatore a 2 vie, soffione a soffitto "easy fix" in acciaio inox 357EFS34, saliscendi quadrato in ottone 317S, presa acqua a muro, doccetta quadrata in ABS, 1 funzione 317SD, flessibile 150 cm.

Shower set including: built-in mixer with 2-way diverter, stainless steel ceiling "easy fix" shower head 357EFS34, square brass sliding rail 317S, wall water connection, 1-function abs square hand shower 317SD, 150 cm flexible hose.



AU92S01EFS34

Soffione doccia EASY FIX in acciaio INOX lucidato a specchio 34x34 cm.
Con getti anticalcare.
EASY FIX stainless steel mirror polished shower head 34x34 cm.
With antilimestone jets.

AU92S01EFS44

Soffione doccia EASY FIX in acciaio INOX lucidato a specchio 44x44 cm.
Con getti anticalcare.
EASY FIX stainless steel mirror polished shower head 44x44 cm.
With antilimestone jets.



Set doccia composto da: miscelatore a incasso con deviatore a 2 vie, soffione a soffitto "easy fix" in acciaio inox 357EFS34, presa acqua a muro con supporto doccetta, doccetta quadrata in ABS, 1 funzione 317SD, flessibile 150 cm.

Shower set including: built-in mixer with 2-way diverter, stainless steel ceiling "easy fix" shower head 357EFS34, wall water connection with shower holder, 1-function abs square hand shower 317SD, 150 cm flexible hose.



AU92S02EFS34

Soffione doccia EASY FIX in acciaio INOX lucidato a specchio 34x34 cm.
Con getti anticalcare.
EASY FIX stainless steel mirror polished shower head 34x34 cm.
With antilimestone jets.

AU92S02EFS44

Soffione doccia EASY FIX in acciaio INOX lucidato a specchio 44x44 cm.
Con getti anticalcare.
EASY FIX stainless steel mirror polished shower head 44x44 cm.
With antilimestone jets.

BOX INCASSO
BUILT-IN BOXKIT WELLNESS
WELLNESS KITCROMOTERAPIA
COLOR THERAPYSOFFIONI
SHOWER HEADSBOCCHE
SPOUTSPANNELLI DOCCIA
SHOWER PANELSCOLONNE DOCCIA
SHOWER COLUMNSSALISCENDI
SLIDING RAILSDOCCETTE
HAND SHOWERS

SHUT-OFF

BORDO VASCA
DECK BATH MIXERFLESSIBILI DOCCIA
SHOWER FLEXIBLES

KIT WELLNESS TONDI | ROUND WELLNESS KIT



X09S01

Set doccia composto da: miscelatore a incasso con deviatore, soffione in acciaio inox Ø 20 cm 357UFM20X, braccio in ottone 30 cm, saliscendi minimale 317M, presa acqua a muro, doccetta minimale in ottone, 1 funzione 317MM, flessibile 150 cm.

Shower set including: built-in mixer with diverter, stainless steel Ø 20cm shower head 357UFM20X, brass arm 30 cm, minimal sliding rail 317M, wall water connection, 1-function brass hand shower 317MM, 150 cm flexible hose.

X09S01UFM25

Con soffione da 25x25 cm e braccio a parete 30 cm.
With shower head 25x25 cm and wall arm 30 cm.

X09S01UFM30

Con soffione da 30x30 cm e braccio a parete 30 cm.
With shower head 30x30 cm and wall arm 30 cm.



X09S02

Set doccia composto da: miscelatore a incasso con deviatore, soffione in acciaio inox Ø 20 cm 357UFM20X, braccio in ottone 30 cm, presa acqua a muro con supporto doccetta, doccetta minimale in ottone, 1 funzione 317MM, flessibile 150 cm.

Shower set including: built-in mixer with diverter, stainless steel Ø 20cm shower head 357UFM20X, brass arm 30 cm, wall water connection with shower holder, 1-function brass hand shower 317MM, 150 cm flexible hose.

X09S02UFM25

Con soffione da 25x25 cm e braccio a parete 30 cm.
With shower head 25x25 cm and wall arm 30 cm.

X09S02UFM30

Con soffione da 30x30 cm e braccio a parete 30 cm.
With shower head 30x30 cm and wall arm 30 cm.



X96S02

Set doccia composto da: miscelatore a incasso orizzontale con deviatore, soffione in acciaio inox Ø 20 cm 357UFM20X, braccio in ottone 30 cm, presa acqua a muro con supporto doccetta, doccetta minimale in ottone, 1 funzione 317MM, flessibile 150 cm.

Shower set including: horizontal built-in mixer with diverter, stainless steel Ø 20cm shower head 357UFM20X, brass arm 30 cm, wall water connection with shower holder, 1-function brass hand shower 317MM, 150 cm flexible hose.

X96S02UFM25

Con soffione da 25x25 cm e braccio a parete 30 cm.
With shower head 25x25 cm and wall arm 30 cm.

X96S02UFM30

Con soffione da 30x30 cm e braccio a parete 30 cm.
With shower head 30x30 cm and wall arm 30 cm.



X09S01EC20

Set doccia composto da: miscelatore a incasso con deviatore, soffione in abs Ø 20cm 354EC20X, braccio in ottone 30 cm, saliscendi minimale 317M, presa acqua a muro, doccetta in abs, 1 funzione 317MD, flessibile 150 cm.

Shower set including: built-in mixer with diverter, abs Ø 20 cm shower head 354EC20X, brass arm 30 cm, minimal sliding rail 317M, wall water connection, 1-function abs hand shower 317MD, 150 cm flexible hose.



X09S02EC20

Set doccia composto da: miscelatore a incasso con deviatore, soffione in abs Ø 20cm 354EC20X, braccio in ottone 30 cm, presa acqua a muro con supporto doccetta, doccetta in abs, 1 funzione 317MD, flessibile 150 cm.

Shower set including: built-in mixer with diverter, abs Ø 20 cm shower head 354EC20X, brass arm 30 cm, wall water connection with shower holder, 1-function abs hand shower 317MD, 150 cm flexible hose.





X09S01LO20

CON OPZIONI DI FINITURA WITH FINISHING OPTIONS

**X09S01LO20**

Set doccia composto da: miscelatore a incasso con deviatore, soffione in ottone Ø 20 cm 359MM20X, braccio in ottone 30 cm, saliscendi in ottone 317G, presa acqua a muro, doccetta minimale in ottone, 1 funzione 317MM, flessibile 150 cm.

Shower set including: built-in mixer with diverter, brass shower head Ø 20 cm 359MM20X, brass arm 30 cm, brass sliding rail 317G, wall water connection, 1-function brass hand shower 317MM, 150 cm flexible hose.

**X09S02LO20**

Set doccia composto da: miscelatore a incasso con deviatore, soffione in ottone Ø 20 cm 359MM20X, braccio in ottone 30 cm, presa acqua a muro con supporto doccetta, doccetta minimale in ottone, 1 funzione 317MM, flessibile 150 cm.

Shower set including: built-in mixer with diverter, brass shower head Ø 20 cm 359MM20X, brass arm 30 cm, wall water connection with shower holder, 1-function brass hand shower 317MM, 150 cm flexible hose.

**X09S01LO30**

con soffione da Ø 30 cm.
with shower head Ø 30 cm.

**X09S02LO30**

con soffione da Ø 30 cm.
with shower head Ø 30 cm.



FIN 1

NO

BO

NP

NPO

FIN 2

CFP

BG

DO

BOX INCASSO
BUILT-IN BOXKIT WELLNESS
WELLNESS KITCROMOTERAPIA
COLOR THERAPYSOFFIONI
SHOWER HEADSBOCCHE
SPOUTSPANNELLI DOCCIA
SHOWER PANELSCOLONNE DOCCIA
SHOWER COLUMNSSALISCENDI
SLIDING RAILSDOCCETTE
HAND SHOWERS

SHUT-OFF

BORDO VASCA
DECK BATH MIXERFLESSIBILI DOCCIA
SHOWER FLEXIBLES

KIT WELLNESS - WELLNESS KIT



Set doccia composto da: miscelatore a incasso con deviatore, soffione in abs 356MD20X, braccio in ottone 30 cm, saliscendi minimale 317M, presa acqua a muro, doccetta in abs, 1 funzione 317MD, flessibile 150 cm.

Shower set including: built-in mixer with diverter, abs shower head 356MD20X, brass arm 30 cm, minimal sliding rail 317M, wall water connection, 1-function abs hand shower 317MD, 150 cm flexible hose.



X09S01MD20

con soffione da Ø20 cm e braccio a parete 30 cm.
with shower head Ø20 cm and wall arm 30 cm.

X09S01MD25

con soffione da Ø25 cm e braccio a parete 30 cm.
with shower head Ø25 cm and wall arm 30 cm.

X09S01MD30

con soffione da Ø30 cm e braccio a parete 30 cm.
with shower head Ø30 cm and wall arm 30 cm.



Set doccia composto da: miscelatore a incasso con deviatore, soffione in abs 356MD20X, braccio in ottone 30 cm, presa acqua a muro con supporto doccetta, doccetta in abs, 1 funzione 317MD, flessibile 150 cm.

Shower set including: built-in mixer with diverter, abs shower head 356MD20X, brass arm 30 cm, wall water connection with shower holder, 1-function abs hand shower 317MD, 150 cm flexible hose.



X09S02MD20

con soffione da Ø20 cm e braccio a parete 30 cm.
with shower head Ø20 cm and wall arm 30 cm.

X09S02MD25

con soffione da Ø25 cm e braccio a parete 30 cm.
with shower head Ø25 cm and wall arm 30 cm.

X09S02MD30

con soffione da Ø30 cm e braccio a parete 30 cm.
with shower head Ø30 cm and wall arm 30 cm.



X09S01MM

Set doccia composto da: miscelatore a incasso con deviatore, soffione a parete in acciaio inox con getto a pioggia 350MMX, saliscendi minimale 317M, presa acqua a muro, doccetta in abs, 1 funzione 317MD, flessibile 150 cm.

Shower set including: built-in mixer with diverter, wall-mounted stainless steel shower head with rain jet 350MMX, minimal sliding rail 317M, wall water connection, 1-function abs hand shower 317MD, 150 cm flexible hose.



X09S02MM

Set doccia composto da: miscelatore a incasso con deviatore, soffione a parete in acciaio inox con getto a pioggia 350MMX, presa acqua a muro con supporto doccetta, doccetta in abs, 1 funzione 317MD, flessibile 150 cm.

Shower set including: built-in mixer with diverter, wall-mounted stainless steel shower head with rain jet 350MMX, wall water connection with shower holder, 1-function abs hand shower 317MD, 150 cm flexible hose.



X93S01MMCA

Set doccia composto da: miscelatore a incasso con deviatore a 3 vie, soffione a parete in acciaio inox con getto a pioggia e cascata 350MMCAX, saliscendi minimale 317M, presa acqua a muro, doccetta in abs, 1 funzione 317MD, flessibile 150 cm.

Shower set including: built-in mixer with 3-way diverter, wall mounted stainless steel shower head with rain and waterfall functions 350MMCAX, minimal sliding rail 317M, wall water connection, 1-function abs hand shower 317MD, 150 cm flexible hose.



X93S02MMCA

Set doccia composto da: miscelatore a incasso con deviatore a 3 vie, soffione a parete in acciaio inox con getto a pioggia e cascata 350MMCAX, presa acqua a muro con supporto doccetta, doccetta in abs, 1 funzione 317MD, flessibile 150 cm.

Shower set including: built-in mixer with 3-way diverter, wall mounted stainless steel shower head with rain and waterfall functions 350MMCAX, wall water connection with shower holder, 1-function abs hand shower 317MD, 150 cm flexible hose.





Set doccia composto da: miscelatore a incasso con deviatore a 3 vie, soffione in acciaio inox 357UFM20X, braccio in ottone 30 cm, saliscendi minimale 317M, presa acqua a muro, doccetta in abs, 1 funzione 317MD, 6 getti tondi, flessibile 150 cm.

Shower set including: built-in mixer with 3-way diverter, stainless steel shower head 357UFM20X, brass arm 30 cm, minimal sliding rail 317M, wall water connection, 1-function abs hand shower 317MD, 6 round body jets, 150 cm flexible hose.



X93S01UFM20

con soffione da Ø20 cm e braccio a parete 30 cm.
with shower head Ø20 cm and wall arm 30 cm.

X93S01UFM25

con soffione da Ø25 cm e braccio a parete 30 cm.
with shower head Ø25 cm and wall arm 30 cm.

X93S01UFM30

con soffione da Ø30 cm e braccio a parete 30 cm.
with shower head Ø30 cm and wall arm 30 cm.



Set doccia composto da: miscelatore a incasso con deviatore a 3 vie, soffione in acciaio inox 357UFM20X, braccio in ottone 30 cm, presa acqua a muro con supporto doccetta, doccetta in abs, 1 funzione 317MD, 6 getti tondi, flessibile 150 cm.

Shower set including: built-in mixer with 3-way diverter, stainless steel shower head 357UFM20X, brass arm 30 cm, wall water connection with shower holder, 1-function abs hand shower 317MD, 6 round body jets, 150 cm flexible hose.



X93S02UFM20

con soffione da Ø20 cm e braccio a parete 30 cm.
with shower head Ø20 cm and wall arm 30 cm.

X93S02UFM25

con soffione da Ø25 cm e braccio a parete 30 cm.
with shower head Ø25 cm and wall arm 30 cm.

X93S02UFM30

con soffione da Ø30 cm e braccio a parete 30 cm.
with shower head Ø30 cm and wall arm 30 cm.



X93S01MM

Con soffione doccia a parete 50x20 cm, in acciaio inox lucidato a specchio.
With stainless steel mirror polished wall shower head 50x20 cm.



X93S02MM

Con soffione doccia a parete 50x20 cm, in acciaio inox lucidato a specchio.
With stainless steel mirror polished wall shower head 50x20 cm.

CON SOFFIONI A SOFFITTO - CEILING SHOWER HEAD



Set doccia composto da: miscelatore a incasso con deviatore a 2 vie, soffione a soffitto "easy fix" in acciaio inox 357EFM34, saliscendi minimale 317M, presa acqua a muro, doccetta in abs, 1 funzione 317MD, flessibile 150 cm.

Shower set including: built-in mixer with 2-way diverter, stainless steel ceiling "easy fix" shower head 357EFM34, minimal sliding rail 317M, wall water connection, 1-function abs hand shower 317MD, 150 cm flexible hose.



X92S01EFM34

Soffione doccia EASY FIX in acciaio INOX lucidato a specchio Ø 34 cm.
Con getti anticalcare.
EASY FIX stainless steel mirror polished shower head Ø 34 cm.
With antilimestone jets.

X92S01EFM44

Soffione doccia EASY FIX in acciaio INOX lucidato a specchio Ø 44 cm.
Con getti anticalcare.
EASY FIX stainless steel mirror polished shower head Ø 44 cm.
With antilimestone jets.



Set doccia composto da: miscelatore a incasso con deviatore a 2 vie, soffione a soffitto "easy fix" in acciaio inox 357EFM34, presa acqua a muro con supporto doccetta, doccetta in abs, 1 funzione 317MD, flessibile 150 cm.

Shower set including: built-in mixer with 2-way diverter, stainless steel ceiling "easy fix" shower head 357EFM34, wall water connection with shower holder, 1-function abs hand shower 317MD, 150 cm flexible hose.



X92S02EFM34

Soffione doccia EASY FIX in acciaio INOX lucidato a specchio Ø 34 cm.
Con getti anticalcare.
EASY FIX stainless steel mirror polished shower head Ø 34 cm.
With antilimestone jets.

X92S02EFM44

Soffione doccia EASY FIX in acciaio INOX lucidato a specchio Ø 44 cm.
Con getti anticalcare.
EASY FIX stainless steel mirror polished shower head Ø 44 cm.
With antilimestone jets.

BOX INCASSO
BUILT-IN BOXKIT WELLNESS
WELLNESS KITCROMOTERAPIA
COLOR THERAPYSOFFIONI
SHOWER HEADSBOCCHE
SPOUTSPANNELLI DOCCIA
SHOWER PANELSCOLONNE DOCCIA
SHOWER COLUMNSSALISCENDI
SLIDING RAILSDOCCETTE
HAND SHOWERS

SHUT-OFF

BORDO VASCA
DECK BATH MIXERFLESSIBILI DOCCIA
SHOWER FLEXIBLES

KIT WELLNESS THERMOSTATICI QUADRATI

SQUARED THERMOSTATIC WELLNESS KIT



Set doccia composto da: miscelatore termostatico a incasso con deviatore, soffione in acciaio inox 357UFS20X, braccio quadrato in ottone 30 cm, saliscendi quadrato in ottone 317S, presa acqua a muro, doccetta quadrata in ABS, 1 funzione 317SD, flessibile 150 cm.

Shower set including: thermostatic built-in mixer with diverter, stainless steel shower head 357UFS20X, square brass arm 30 cm, square brass sliding rail 317S, wall water connection, 1-function abs square hand shower 317SD, 150 cm flexible hose.



QT09S01UFS20

con soffione da 20x20 cm e braccio a parete 30 cm.
with shower head 20x20 cm and wall arm 30 cm.

QT09S01UFS25

con soffione da 25x25 cm e braccio a parete 30 cm.
with shower head 25x25 cm and wall arm 30 cm.

QT09S01UFS30

con soffione da 30x30 cm e braccio a parete 30 cm.
with shower head 30x30 cm and wall arm 30 cm.



Set doccia composto da: miscelatore termostatico a incasso con deviatore, soffione in acciaio inox 357UFS20X, braccio quadrato in ottone 30 cm, presa acqua a muro con supporto doccetta, doccetta quadrata in ABS, 1 funzione 317SD, flessibile 150 cm.

Shower set including: thermostatic built-in mixer with diverter, stainless steel 20x20cm shower head 357UFS20X, square brass arm 30 cm, wall water connection with shower holder, 1-function abs square hand shower 317SD, 150 cm flexible hose.



QT09S02UFS20

con soffione da 20x20 cm e braccio a parete 30 cm.
with shower head 20x20 cm and wall arm 30 cm.

QT09S02UFS25

con soffione da 25x25 cm e braccio a parete 30 cm.
with shower head 25x25 cm and wall arm 30 cm.

QT09S02UFS30

con soffione da 30x30 cm e braccio a parete 30 cm.
with shower head 30x30 cm and wall arm 30 cm.



QT09S017SDSS

Set doccia composto da: miscelatore termostatico a incasso con deviatore, soffione a parete in acciaio inox con getto a pioggia 350SSX, saliscendi quadrato in ottone 317S, presa acqua a muro, doccetta quadrata in ABS, 1 funzione 317SD, flessibile 150 cm.

Shower set including: thermostatic built-in mixer with diverter, wall-mounted stainless steel shower head with rain jet 350SSX square brass sliding rail 317S, wall water connection, 1-function abs square hand shower 317SD, 150 cm flexible hose.



QT09S027SDQSS

Set doccia composto da: miscelatore termostatico a incasso con deviatore, soffione a parete in acciaio inox con getto a pioggia 350SSX, presa acqua a muro con supporto doccetta, doccetta quadrata in ABS, 1 funzione 317SD, flessibile 150 cm.

Shower set including: thermostatic built-in mixer with diverter, wall-mounted stainless steel shower head with rain jet 350SSX, wall water connection with shower holder, 1-function abs square hand shower 317SD, 150 cm flexible hose..



KIT WELLNESS TERMOSTATICI TONDI

ROUND THERMOSTATIC WELLNESS KIT



Set doccia composto da: miscelatore termostatico a incasso con deviatore, soffione in acciaio inox 357UFM20X, braccio in ottone 30 cm, saliscendi minimale 317M, presa acqua a muro, doccetta in abs, 1 funzione 317MD, flessibile 150 cm.

Shower set including: thermostatic built-in mixer with diverter, stainless steel shower head 357UFM20X, brass arm 30 cm, minimal sliding rail 317M, wall water connection, 1-function abs hand shower 317MD, 150 cm flexible hose.



NT09S01UFM20

con soffione da Ø20 cm e braccio a parete 30 cm.
with shower head Ø20 cm and wall arm 30 cm.

NT09S01UFM25

con soffione da Ø25 cm e braccio a parete 30 cm.
with shower head Ø25 cm and wall arm 30 cm.

NT09S01UFM30

con soffione da Ø30 cm e braccio a parete 30 cm.
with shower head Ø30 cm and wall arm 30 cm.



Set doccia composto da: miscelatore termostatico a incasso con deviatore, soffione in acciaio inox 357UFM20X, braccio in ottone 30 cm, presa acqua a muro con supporto doccetta, doccetta in abs, 1 funzione 317MD, flessibile 150 cm.

Shower set including: thermostatic built-in mixer with diverter, stainless steel Ø 20cm shower head 357UFM20X, brass arm 30 cm, wall water connection with shower holder, 1-function abs hand shower 317MD, 150 cm flexible hose.



NT09S02UFM20

con soffione da Ø20 cm e braccio a parete 30 cm.
with shower head Ø20 cm and wall arm 30 cm.

NT09S02UFM25

con soffione da Ø25 cm e braccio a parete 30 cm.
with shower head Ø25 cm and wall arm 30 cm.

NT09S02UFM30

con soffione da Ø30 cm e braccio a parete 30 cm.
with shower head Ø30 cm and wall arm 30 cm.



NT09S017MDMM

Set doccia composto da: miscelatore termostatico a incasso con deviatore, soffione a parete in acciaio inox con getto a pioggia 350MMX, saliscendi minimale 317M, presa acqua a muro, doccetta in abs, 1 funzione 317MD, flessibile 150 cm.

Shower set including: thermostatic built-in mixer with diverter, wall-mounted stainless steel shower head with rain jet 350MMX, minimal sliding rail 317M, wall water connection, 1-function abs hand shower 317MD, 150 cm flexible hose.



NT09S027MDMM

Set doccia composto da: miscelatore termostatico a incasso con deviatore, soffione a parete in acciaio inox con getto a pioggia 350MMX, presa acqua a muro con supporto doccetta, doccetta in abs, 1 funzione 317MD, flessibile 150 cm.

Shower set including: thermostatic built-in mixer with diverter, wall-mounted stainless steel shower head with rain jet 350MMX, wall water connection with shower holder, 1-function abs hand shower 317MD, 150 cm flexible hose.

BOX INCASSO
BUILT-IN BOXKIT WELLNESS
WELLNESS KITCROMOTERAPIA
COLOR THERAPYSOFFIONI
SHOWER HEADSBOCCHE
SPOUTSPANNELLI DOCCIA
SHOWER PANELSCOLONNE DOCCIA
SHOWER COLUMNSSALISCENDI
SLIDING RAILSDOCCETTE
HAND SHOWERS

SHUT-OFF

BORDO VASCA
DECK BATH MIXERFLESSIBILI DOCCIA
SHOWER FLEXIBLES

CROMOTERAPIA - COLOR THERAPY

CROMOTERAPIA COLOR THERAPY



Grazie all'utilizzo della tecnologia LED, i soffioni con funzioni di CROMOTERAPIA aggiungono al piacere della doccia il relax psico-fisico di una luce colorata. Le opzioni di cromoterapia, che includono selezione di luce bianca, selezione colori e cromoterapia automatica, possono essere gestite, a seconda del modello, tramite una pulsantiera installata a parete oppure tramite un telecomando wireless (verificare le specifiche tecniche di ogni singolo articolo).

Thanks to the use of LED technology, the shower heads with COLOURTHERAPY functions add the psycho-physical relaxation of colored light to the pleasure of the shower. Colourtherapy options, including white light selection, color selection and automatic colourtherapy, can be managed, depending on the model, via a wall-mounted push-button panel or via a wireless remote control (check the technical specifications of each item).



BOX INCASSO
BUILT-IN BOX

KIT WELLNESS
WELLNESS KIT

CROMOTERAPIA
COLOR THERAPY

SOFFIONI
SHOWER HEADS

BOCCHE
SPOUTS

PANNELLI DOCCIA
SHOWER PANELS

COLONNE DOCCIA
SHOWER COLUMNS

SALISCENDI
SLIDING RAILS

DOCCHETTE
HAND SHOWERS

SHUT-OFF

BORDO VASCA
DECK BATH MIXER

FLESSIBILI DOCCIA
SHOWER FLEXIBLES

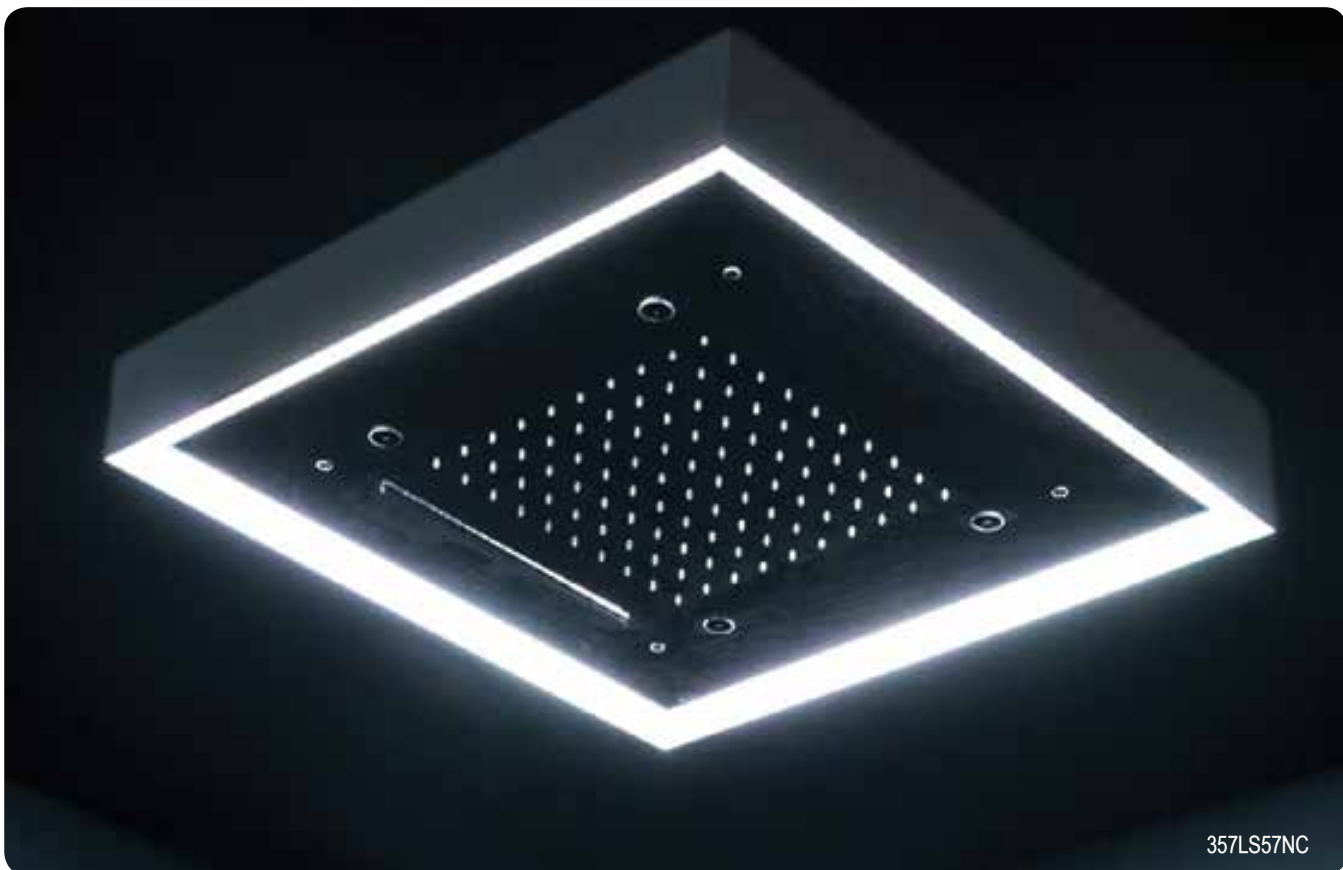

357LS57NC

Disponibili, su richiesta, in finitura;
Available, on request, in finish;

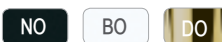

IN DOTAZIONE AI MODELLI - SUPPLIED THE MODEL



Pulsantiera a parete per accensione luce bianca, selezione colori e cromoterapia automatica.
Wall push-button to turn, on, select the colors and change of the jet.

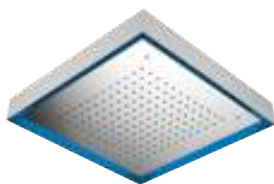
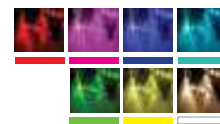

357LS20

Soffione retroilluminato a soffitto in Acciaio INOX anticalcare 20x20 cm, con getto a pioggia. Luce LED a 7 colori con 40 sfumature, alimentazione dalla rete elettrica con trasformatore a basso voltaggio incluso (12V). Pulsantiera a parete inclusa.

Ceiling stainless steel backlighted antilimestone shower head 20x20 cm, with 1 rain jet. 7 colors light led with 40 shades. Powered by electricity with low voltage transformer included (12V). Wall push-button included.

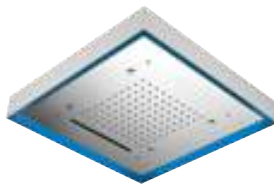

357LS57NC

Soffione retroilluminato a soffitto in Acciaio INOX anticalcare 57x57 cm, con 3 funzioni: getto a pioggia, nebulizzazione (4 uscite) ed 1 getto a cascata. Luce LED a 7 colori con 40 sfumature, alimentazione dalla rete elettrica con trasformatore a basso voltaggio incluso (12V). Pulsantiera a parete inclusa.

Ceiling stainless steel backlighted antilimestone shower head 57x57 cm, with 3 functions: 1 rain jet nebulization (4 outlets) and 1 waterfall jet. 7 colors light led with 40 shades. Powered by electricity with low voltage transformer included (12V). Wall push-button included.

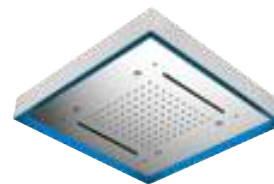

357LS57N2C

Soffione retroilluminato a soffitto in Acciaio INOX anticalcare 57x57 cm, con 3 funzioni: getto a pioggia, nebulizzazione (4 uscite) e 2 getti a cascata. Luce LED a 7 colori con 40 sfumature, alimentazione dalla rete elettrica con trasformatore a basso voltaggio incluso (12V). Pulsantiera a parete inclusa.

Ceiling stainless steel backlighted antilimestone shower head 57x57 cm, with 3 functions: 1 rain jet nebulization (4 outlets) and 2 waterfall jets. 7 colors light led with 40 shades. Powered by electricity with low voltage transformer included (12V). Wall push-button included.



357LS37

con soffione da 37 x 37 cm.
with shower head 37 x 37 cm.

357LS57

con soffione da 57 x 57 cm.
with shower head 57 x 57 cm.





357LR7747N2C

Disponibili, su richiesta, in finitura;
Available, on request, in finish;

NO

BO

DO

IN DOTAZIONE AI MODELLI - SUPPLIED THE MODEL

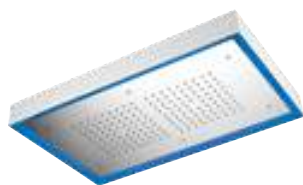
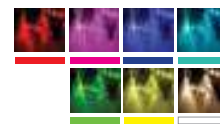

Pulsantiera a parete per accensione luce bianca, selezione colori e cromoterapia automatica.
Wall push-button to turn, on, select the colors and change of the jet.

**357LR7747**

Soffione retroilluminato a soffitto in Acciaio INOX anticalcare 77x47 cm, con 2 postazioni pioggia. Luce LED a 7 colori con 40 sfumature, alimentazione dalla rete elettrica con trasformatore a basso voltaggio incluso (12V). Pulsantiera a parete inclusa.

Ceiling stainless steel backlighted antilimestone shower head 77x47 cm, with 2 workstations rain jet. 7 colors light led with 40 shades. Powered by electricity with low voltage transformer included (12V). Wall push-button included.

**357LR7747N2C**

Soffione a soffitto in Acciaio INOX 77x47 cm, con 3 funzioni: 2 getti cascata, nebulizzazione (4 uscite) e 2 postazioni pioggia. Luce LED a 7 colori con 40 sfumature, alimentazione dalla rete elettrica con trasformatore a basso voltaggio incluso (12V). Pulsantiera a parete inclusa.

Ceiling stainless steel backlighted antilimestone shower head 77x47 cm, with 3 functions: 2 workstations rain jet, nebulization (4 outlets) and 2 waterfall jets. 7 colors light led with 40 shades. Powered by electricity with low voltage transformer included (12V). Wall push-button included.

BOX INCASSO
BUILT-IN BOXKIT WELLNESS
WELLNESS KITCROMOTERAPIA
COLOR THERAPYSOFFIONI
SHOWER HEADSBOCCHE
SPOUTSPANNELLI DOCCIA
SHOWER PANELSCOLONNE DOCCIA
SHOWER COLUMNSSALISCENDI
SLIDING RAILSDOCCETTE
HAND SHOWERS

SHUT-OFF

BORDO VASCA
DECK BATH MIXERFLESSIBILI DOCCIA
SHOWER FLEXIBLES



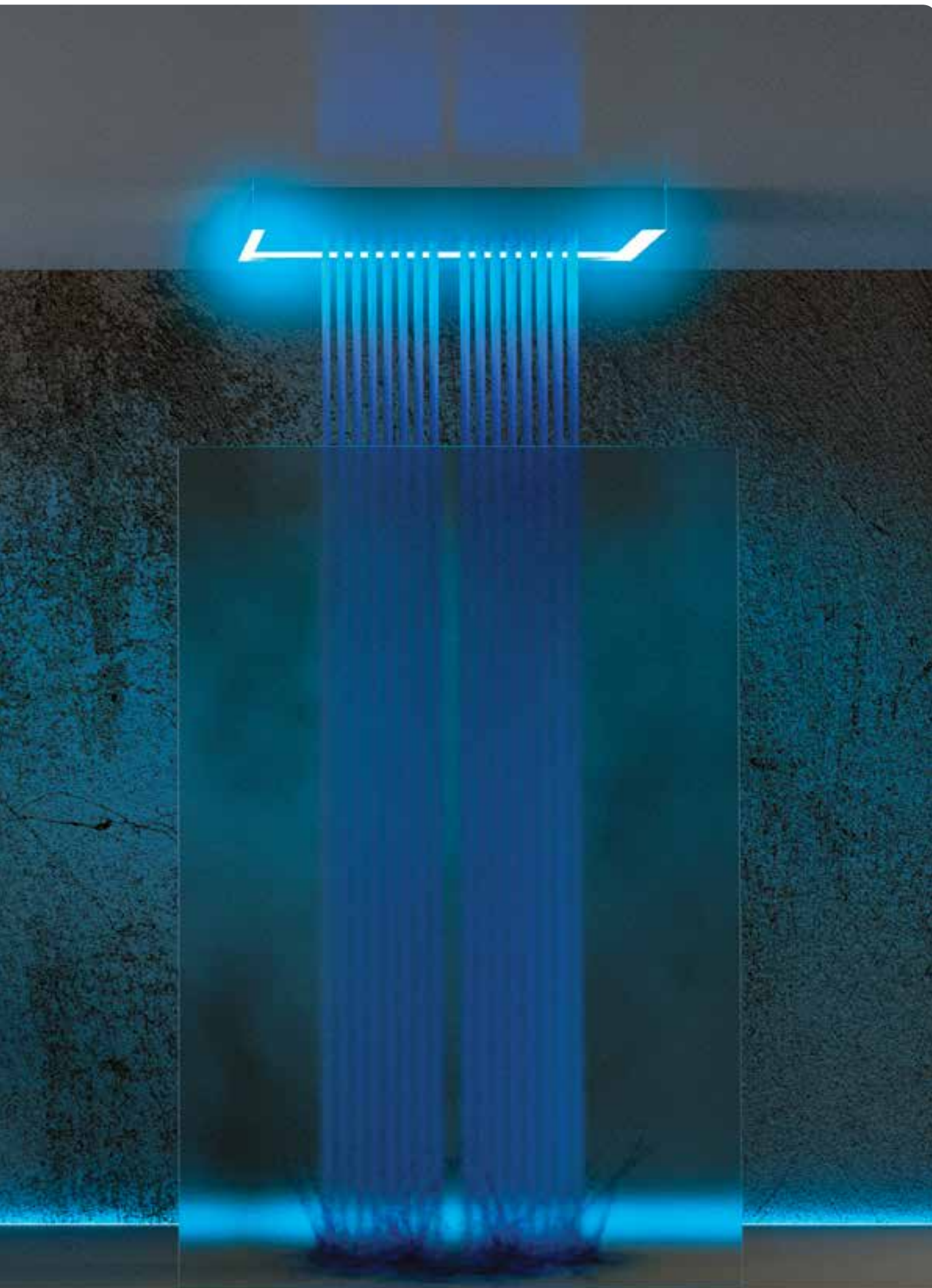

BOX INCASSO
BUILT-IN BOX

KIT WELLNESS
WELLNESS KIT

CRONOTERAPIA
COLOR THERAPY

SOFFIONI
SHOWER HEADS

BOCCHE
SPOUTS

PANNELLI DOCCIA
SHOWER PANELS

COLONNE DOCCIA
SHOWER COLUMNS

SALISCENDI
SLIDING RAILS

DOCCETTE
HAND SHOWERS

SHUT-OFF

BORDO VASCA
DECK BATH MIXER

FLESSIBILI DOCCIA
SHOWER FLEXIBLES



357LM57N

Disponibili, su richiesta, in finitura;
Available, on request, in finish;

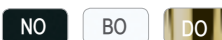

IN DOTAZIONE AI MODELLI - SUPPLIED THE MODEL



Pulsantiera a parete per accensione luce bianca, selezione colori e cromoterapia automatica.
Wall push-button to turn, on, select the colors and change of the jet.

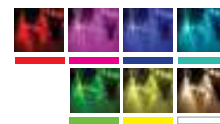

357LM20

Soffione retroilluminato a soffitto in Acciaio INOX anticalcare Ø20 cm, getto pioggia. Luce LED a 7 colori con 40 sfumature, alimentazione dalla rete elettrica con trasformatore a basso voltaggio incluso (12V). Pulsantiera a parete inclusa.
Ceiling stainless steel backlighted antilimestone shower head Ø20 cm, with rain jet. 7 colors light led with 40 shades. Powered by electricity with low voltage transformer included (12V). Wall push-button included.



357LM57N

Soffione retroilluminato a soffitto in Acciaio INOX anticalcare Ø57 cm, con 2 funzioni: getto pioggia e nebulizzazione (4 uscite). Luce LED a 7 colori con 40 sfumature, alimentazione dalla rete elettrica con trasformatore a basso voltaggio incluso (12V). Pulsantiera a parete inclusa.
Ceiling stainless steel backlighted antilimestone shower head Ø57 cm, with 2 functions: rain jet and nebulization (4 outlets). 7 colors light led with 40 shades. Powered by electricity with low voltage transformer included (12V). Wall push-button included.



357LM37

con soffione da Ø37 cm.
with shower head Ø37 cm.

357LM57

con soffione da Ø57 cm.
with shower head Ø57 cm.



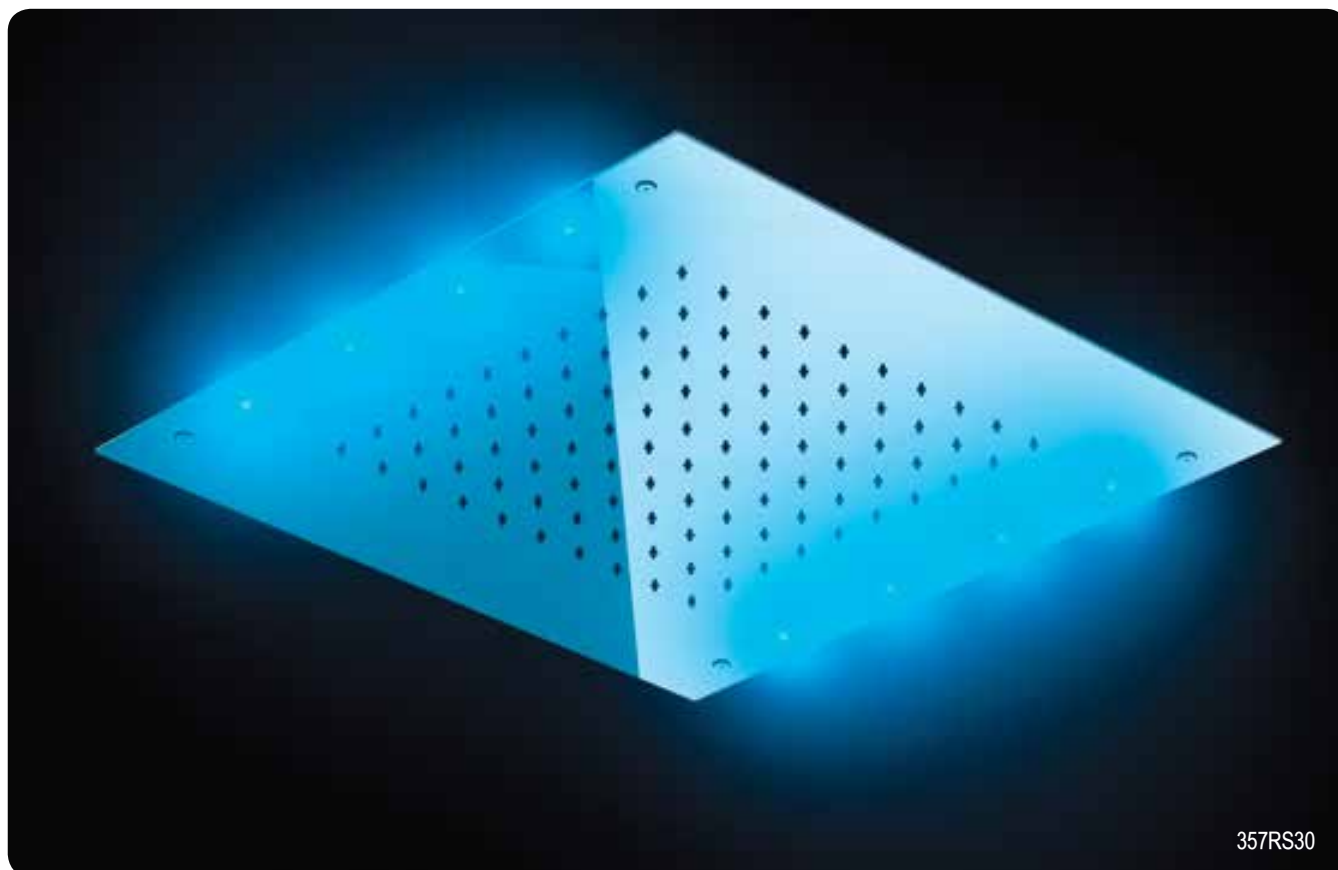

357RS30

Disponibili, su richiesta, in finitura;
Available, on request, in finish;

NO

BO

DO

IN DOTAZIONE IN BASE AI MODELLI - SUPPLIED DEPENDING ON THE MODELS



Pulsantiera a parete per accensione luce bianca, selezione colori e cromoterapia automatica.
Wall push-button to turn, on, select the colors and change of the jet.



W Pulsantiera wireless per accensione luce bianca, selezione colori e cromoterapia automatica.
Wireless push-button to turn, on, select the colors and change of the jet.

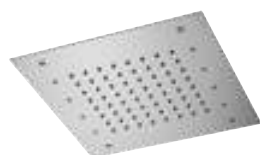
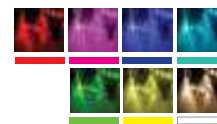

357RS30

Soffione a soffitto in Acciaio INOX lucidato a specchio 30x30 cm, getto a pioggia anticalcare. Luce LED a 7 colori con 40 sfumature, alimentazione dalla rete elettrica con trasformatore a basso voltaggio incluso (12V). Pulsantiera a parete inclusa. Ceiling stainless steel mirror polished shower head 30x30 cm, with antilimestone rain jet. 7 colors light led with 40 shades. Powered by electricity with low voltage transformer included (12V). Wall push-button included.

357RS30W

Come soffione Art. 357 RS30, con pulsantiera wireless inclusa. As art. 357 RS30, with wireless remote control included.



357RS43

Soffione a soffitto in Acciaio INOX lucidato a specchio 43x43 cm, getto a pioggia anticalcare. Luce LED a 7 colori con 40 sfumature, alimentazione dalla rete elettrica con trasformatore a basso voltaggio incluso (12V). Pulsantiera a parete inclusa. Ceiling stainless steel mirror polished shower head 43x43 cm, with antilimestone rain jet. 7 colors light led with 40 shades. Powered by electricity with low voltage transformer included (12V). Wall push-button included.

357RS43W

Come soffione Art. 357 RS43, con pulsantiera wireless inclusa. As art. 357 RS43, with wireless remote control included.



357RS50

Soffione a soffitto in Acciaio INOX lucidato a specchio 50x50 cm, getto a pioggia anticalcare. Luce LED a 7 colori con 40 sfumature, alimentazione dalla rete elettrica con trasformatore a basso voltaggio incluso (12V). Pulsantiera a parete inclusa. Ceiling stainless steel mirror polished shower head 50x50 cm, with antilimestone rain jet. 7 colors light led with 40 shades. Powered by electricity with low voltage transformer included (12V). Wall push-button included.

357RS50W

Come soffione Art. 357 RS50, con pulsantiera wireless inclusa. As art. 357 RS50W, with wireless remote control included.

BOX INCASSO
BUILT-IN BOXKIT WELLNESS
WELLNESS KITCROMOTERAPIA
COLOR THERAPYSOFFIONI
SHOWER HEADSBOCCHE
SPOUTSPANNELLI DOCCIA
SHOWER PANELSCOLONNE DOCCIA
SHOWER COLUMNSSALISCENDI
SLIDING RAILSDOCCETTE
HAND SHOWERS

SHUT-OFF

BORDO VASCA
DECK BATH MIXERFLESSIBILI DOCCIA
SHOWER FLEXIBLES

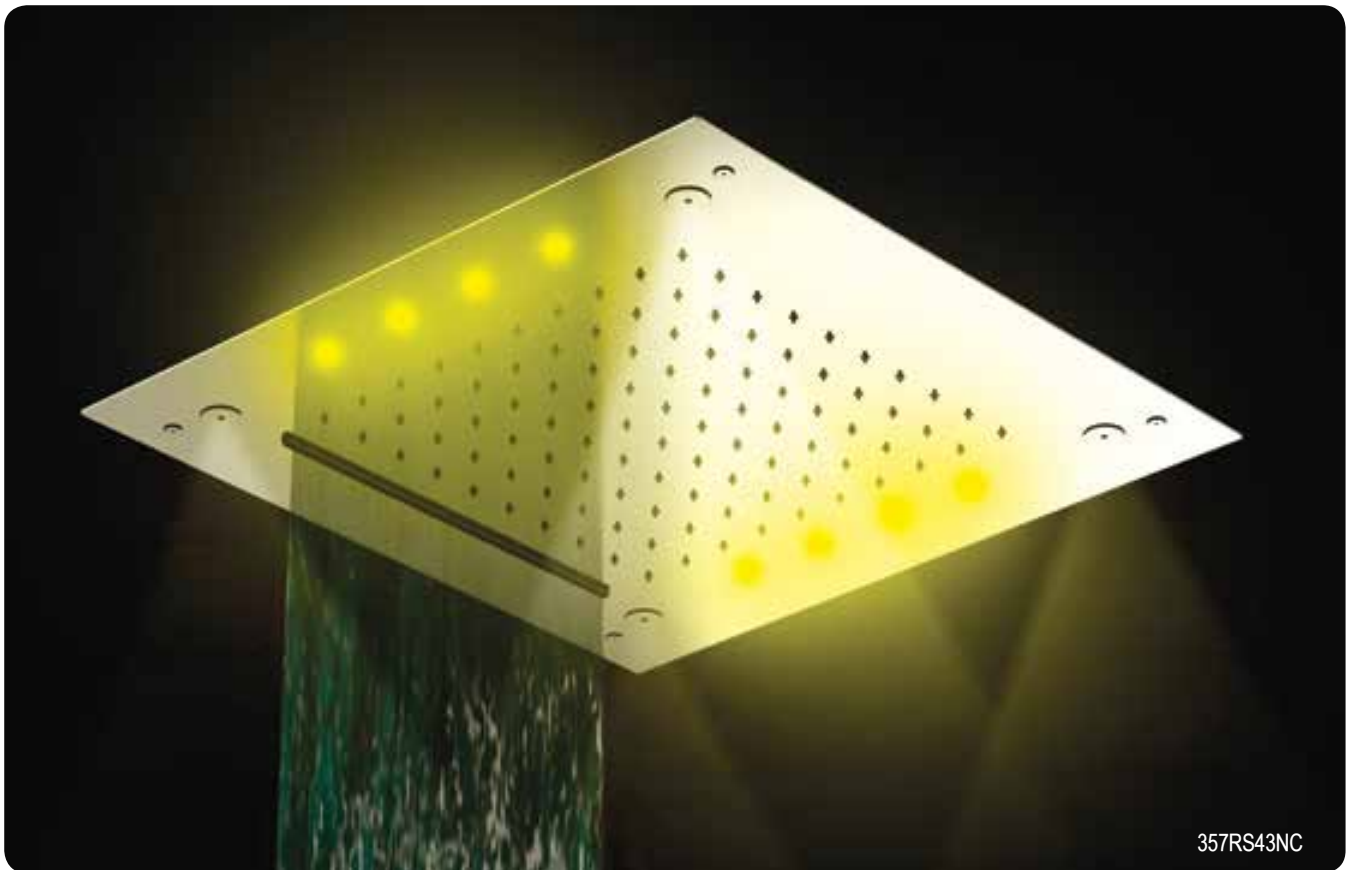

357RS43NC

Disponibili, su richiesta, in finitura;
Available, on request, in finish;

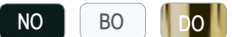

IN DOTAZIONE IN BASE AI MODELLI - SUPPLIED DEPENDING ON THE MODELS



Pulsantiera a parete per accensione luce bianca, selezione colori e cromoterapia automatica.
Wall push-button to turn, on, select the colors and change of the jet.



W Pulsantiera wireless per accensione luce bianca, selezione colori e cromoterapia automatica.
Wireless push-button to turn, on, select the colors and change of the jet.

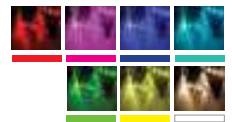

357RS43NC

Soffione a soffitto in Acciaio INOX lucidato a specchio 43x43 cm, con 3 funzioni: getto a pioggia anticalcare, nebulizzazione (4 uscite) e getto a cascata. Luce LED a 7 colori con 40 sfumature, alimentazione dalla rete elettrica con trasformatore a basso voltaggio incluso (12V). Pulsantiera a parete inclusa.
Ceiling stainless steel mirror polished shower head 43x43 cm, with 3 functions: antilimestone rain jet, nebulization (4 outlets) and 1 waterfall jet. 7 colors light led with 40 shades. Powered by electricity with low voltage transformer included (12V). Wall push-button included.

357RS43NCW

Come soffione Art. 357 RS43 NC, con pulsantiera wireless inclusa.
As art. 357 RS43 NC, with wireless remote control included.

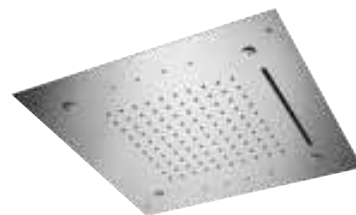

357RS50NC

Soffione a soffitto in Acciaio INOX lucidato a specchio 50x50 cm, con 3 funzioni: getto a pioggia anticalcare, nebulizzazione (4 uscite) e getto a cascata. Luce LED a 7 colori con 40 sfumature, alimentazione dalla rete elettrica con trasformatore a basso voltaggio incluso (12V). Pulsantiera a parete inclusa.
Ceiling stainless steel mirror polished shower head 50x50 cm, with 3 functions: antilimestone rain jet, nebulization (4 outlets) and 1 waterfall jet. 7 colors light led with 40 shades. Powered by electricity with low voltage transformer included (12V). Wall push-button included.

357RS50NCW

Come soffione Art. 357 RS50 NC, con pulsantiera wireless inclusa.
As art. 357 RS50 NC, with wireless remote control included.





357RR7040N2C

Disponibili, su richiesta, in finitura;
Available, on request, in finish;

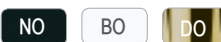

IN DOTAZIONE IN BASE AI MODELLI - SUPPLIED DEPENDING ON THE MODELS



Pulsantiera a parete per accensione luce bianca, selezione colori e cromoterapia automatica.
Wall push-button to turn, on, select the colors and change of the jet.



W Pulsantiera wireless per accensione luce bianca, selezione colori e cromoterapia automatica.
Wireless push-button to turn, on, select the colors and change of the jet.

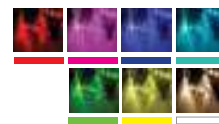

357RR7040

Soffione a soffitto in Acciaio INOX lucidato a specchio 70x40 cm, con 2 postazioni getto a pioggia anticalcare. Luce LED a 7 colori con 40 sfumature, alimentazione dalla rete elettrica con trasformatore a basso voltaggio incluso (12V). Pulsantiera a parete inclusa.

Ceiling stainless steel mirror polished shower head 70x40 cm, 2 antilimestone rain jet workstations. 7 colors light led with 40 shades. Powered by electricity with low voltage transformer included (12V). Wall push-button included.

357RR7040W

Come soffione Art. 357 RR7040, con pulsantiera wireless inclusa.



357RR7040NC

Soffione a soffitto in Acciaio INOX lucidato a specchio 70x40 cm, con 3 funzioni: 2 postazioni getto a pioggia anticalcare, nebulizzazione (4 uscite) ed 1 getto a cascata centrale. Luce LED a 7 colori con 40 sfumature, alimentazione dalla rete elettrica con trasformatore a basso voltaggio incluso (12V). Pulsantiera a parete inclusa.

Ceiling stainless steel mirror polished shower head 70x40 cm, with 3 functions: 2 antilimestone rain jet workstations, nebulization (4 outlets) and 1 central waterfall jet. 7 colors light led with 40 shades. Powered by electricity with low voltage transformer included (12V). Wall push-button included.

357RR7040NCW

Come soffione Art. 357 RR7040 NC, con pulsantiera wireless inclusa.



357RR7040N2C

Soffione a soffitto in Acciaio INOX lucidato a specchio 70x40 cm, con 3 funzioni: getto pioggia anticalcare, nebulizzazione (4 uscite) e 2 getti a cascata laterali. Luce LED a 7 colori con 40 sfumature, alimentazione dalla rete elettrica con trasformatore a basso voltaggio incluso (12V). Pulsantiera a parete inclusa.

Ceiling stainless steel mirror polished shower head 70x40 cm, with 3 functions: antilimestone rain jet, nebulization (4 outlets) and 2 lateral waterfall jet. 7 colors light led with 40 shades. Powered by electricity with low voltage transformer included (12V). Wall push-button included.

357RR7040N2CW

Come soffione Art. 357 RR7040 N2C, con pulsantiera wireless inclusa.



BOX INCASSO
BUILT-IN BOX

KIT WELLNESS
WELLNESS KIT

CROMOTERAPIA
COLOR THERAPY

SOFFIONI
SHOWER HEADS

BOCCHE
SPOUTS

PANNELLI DOCCIA
SHOWER PANELS

COLONNE DOCCIA
SHOWER COLUMNS

SALISCENDI
SLIDING RAILS

DOCCETTE
HAND SHOWERS

SHUT-OFF

BORDO VASCA
DECK BATH MIXER

FLESSIBILI DOCCIA
SHOWER FLEXIBLES



357RM55N

Disponibili, su richiesta, in finitura;
Available, on request, in finish;

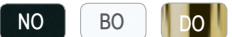

IN DOTAZIONE IN BASE AI MODELLI - SUPPLIED DEPENDING ON THE MODELS



Pulsantiera a parete per accensione luce bianca, selezione colori e cromoterapia automatica.
Wall push-button to turn, on, select the colors and change of the jet.



W
Pulsantiera wireless per accensione luce bianca, selezione colori e cromoterapia automatica.
Wireless push-button to turn, on, select the colors and change of the jet.

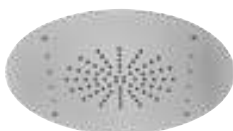
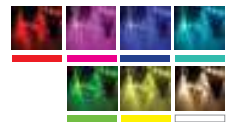

357RM42

Soffione a soffitto in Acciaio INOX lucidato a specchio Ø42 cm, con getto a pioggia anticalcare. Luce LED a 7 colori con 40 sfumature, alimentazione dalla rete elettrica con trasformatore a basso voltaggio incluso (12V). Pulsantiera a parete inclusa.

Ceiling stainless steel mirror polished shower head Ø42 cm, with antilimestone rain jet. 7 colors light led with 40 shades. Powered by electricity with low voltage transformer included (12V). Wall push-button included.



357RM55

Soffione a soffitto in Acciaio INOX lucidato a specchio Ø55 cm, con getto a pioggia anticalcare. Luce LED a 7 colori con 40 sfumature, alimentazione dalla rete elettrica con trasformatore a basso voltaggio incluso (12V). Pulsantiera a parete inclusa.

Ceiling stainless steel mirror polished shower head Ø55 cm, with antilimestone rain jet. 7 colors light led with 40 shades. Powered by electricity with low voltage transformer included (12V). Wall push-button included.



357RM55N

Soffione a soffitto in Acciaio INOX lucidato a specchio Ø55 cm, con 2 funzioni: getto a pioggia anticalcare e nebulizzato (4 uscite). Luce LED a 7 colori con 40 sfumature, alimentazione dalla rete elettrica con trasformatore a basso voltaggio incluso (12V). Pulsantiera a parete inclusa.

Ceiling stainless steel mirror polished shower head Ø55 cm, with 2 functions: antilimestone rain jet and nebulization (4 outlets). 7 colors light led with 40 shades. Powered by electricity with low voltage transformer included (12V). Wall push-button included.



357RM42W

Come soffione Art. 357 RM42, con pulsantiera wireless inclusa.

As art. 357 RM42, with wireless remote control included.



357RM55W

Come soffione Art. 357 RM55, con pulsantiera wireless inclusa.

As art. 357 RM55, with wireless remote control included.



357RM55NW

Come soffione Art. 357 RM55 N, con pulsantiera wireless inclusa.

As art. 357 RM55 N, with wireless remote control included.



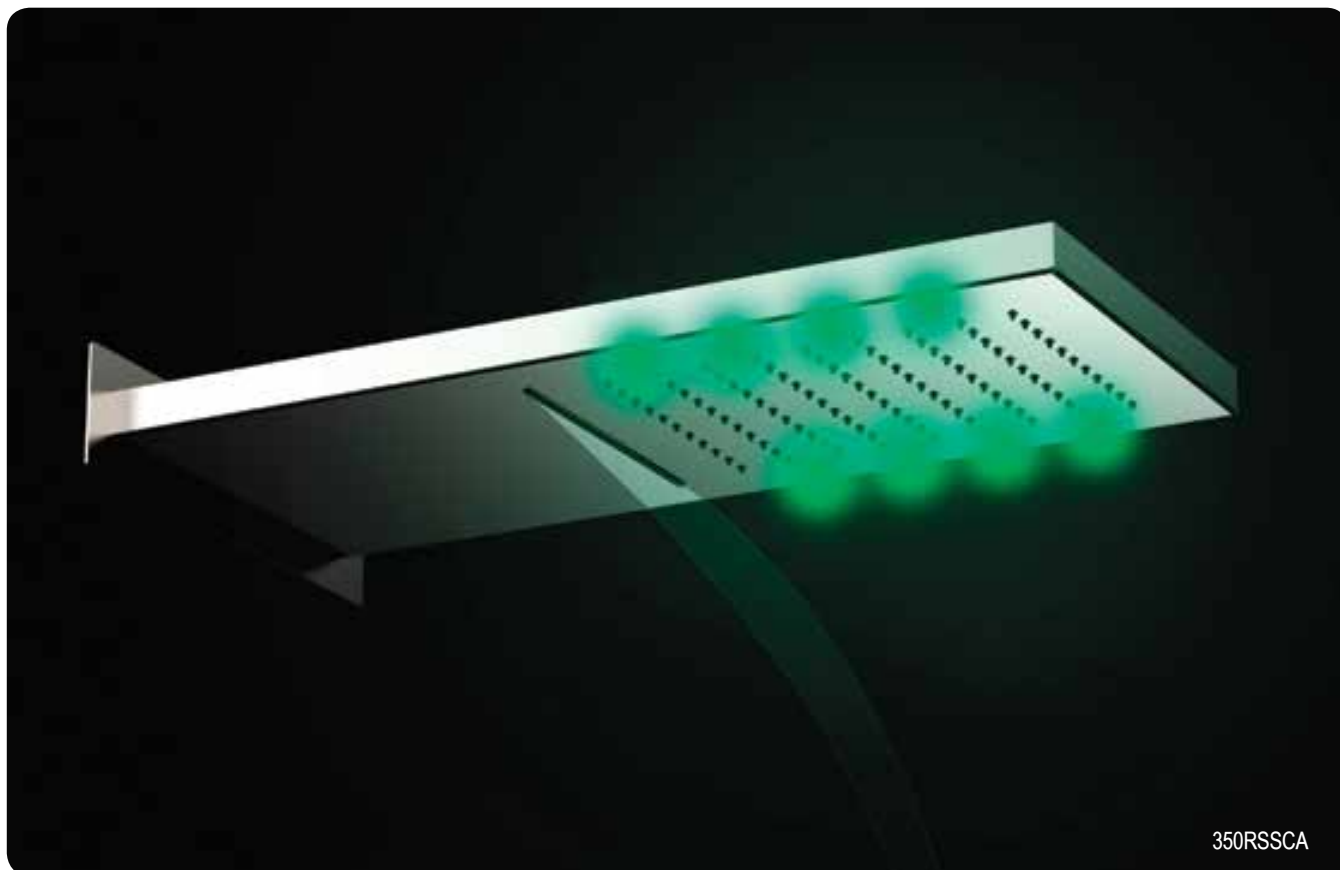

Disponibili, su richiesta, in finitura;
Available, on request, in finish;

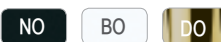

IN DOTAZIONE IN BASE AI MODELLI - SUPPLIED DEPENDING ON THE MODELS



Pulsantiera a parete per accensione luce bianca, selezione colori e cromoterapia automatica.
Wall push-button to turn, on, select the colors and change of the jet.



W Pulsantiera wireless per accensione luce bianca, selezione colori e cromoterapia automatica.
Wireless push-button to turn, on, select the colors and change of the jet.

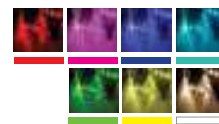

350RSS

Soffione a parete in Acciaio INOX lucidato a specchio 50x26x6,4 cm, con 1 postazione pioggia. Luce LED a 7 colori con 40 sfumature, alimentazione dalla rete elettrica con trasformatore a basso voltaggio incluso (12V). Con pulsantiera a parete inclusa.
Wall stainless steel mirror polished shower head 50x26x6,4 cm, 1 rain jet workstation. 7 colors light led with 40 shades. Powered by electricity with low voltage transformer included (12V). With wall push-button included.

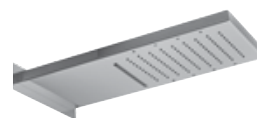

350RSSCA

Soffione a parete in Acciaio INOX lucidato a specchio 50x26x6,4 cm, con 1 postazione pioggia ed 1 getto a cascata. Luce LED a 7 colori con 40 sfumature, alimentazione dalla rete elettrica con trasformatore a basso voltaggio incluso (12V). Con pulsantiera a parete inclusa.
Wall stainless steel mirror polished shower head 50x26x6,4 cm, 1 rain jet workstation and waterfall jet. 7 colors light led with 40 shades. Powered by electricity with low voltage transformer included (12V). With wall push-button included.



350RSSW

Come soffione Art. 350 RSS, con pulsantiera wireless inclusa.
As art. 350 RSS, with wireless remote control included.



350RSSCAW

Come soffione Art. 350 RSSCA, con pulsantiera wireless inclusa.
As art. 50 RSSCA, with wireless remote control included.



BOX INCASSO
BUILT-IN BOX

KIT WELLNESS
WELLNESS KIT

CROMOTERAPIA
COLOR THERAPY

SOFFIONI
SHOWER HEADS

BOCCHE
SPOUTS

PANNELLI DOCCIA
SHOWER PANELS

COLONNE DOCCIA
SHOWER COLUMNS

SALISCENDI
SLIDING RAILS

DOCCETTE
HAND SHOWERS

SHUT-OFF

BORDO VASCA
DECK BATH MIXER

FLESSIBILI DOCCIA
SHOWER FLEXIBLES

SOFFIONI - SHOWER HEADS

SOFFIONI SHOWER HEADS



Una selezione di soffioni doccia diversi per forme, dimensioni, funzioni e materiali che consentono di personalizzare il proprio interno doccia con la soluzione più adatta in termini di estetica e di performance.

A selection of shower heads with different shapes, sizes, functions and materials to customize your shower interior with the most suitable solution in terms of aesthetics and performance.



BOX INCASSO
BUILT-IN BOX

KIT WELLNESS
WELLNESS KIT

CRONOTERAPIA
COLOR THERAPY

SOFFIONI
SHOWER HEADS

BOCCHE
SPOUTS

PANNELLI DOCCIA
SHOWER PANELS

COLONNE DOCCIA
SHOWER COLUMNS

SALISCENDI
SLIDING RAILS

DOCLETTE
HAND SHOWERS

SHUT-OFF

BORDO VASCA
DECK BATH MIXER

FLESSIBILI DOCCIA
SHOWER FLEXIBLES

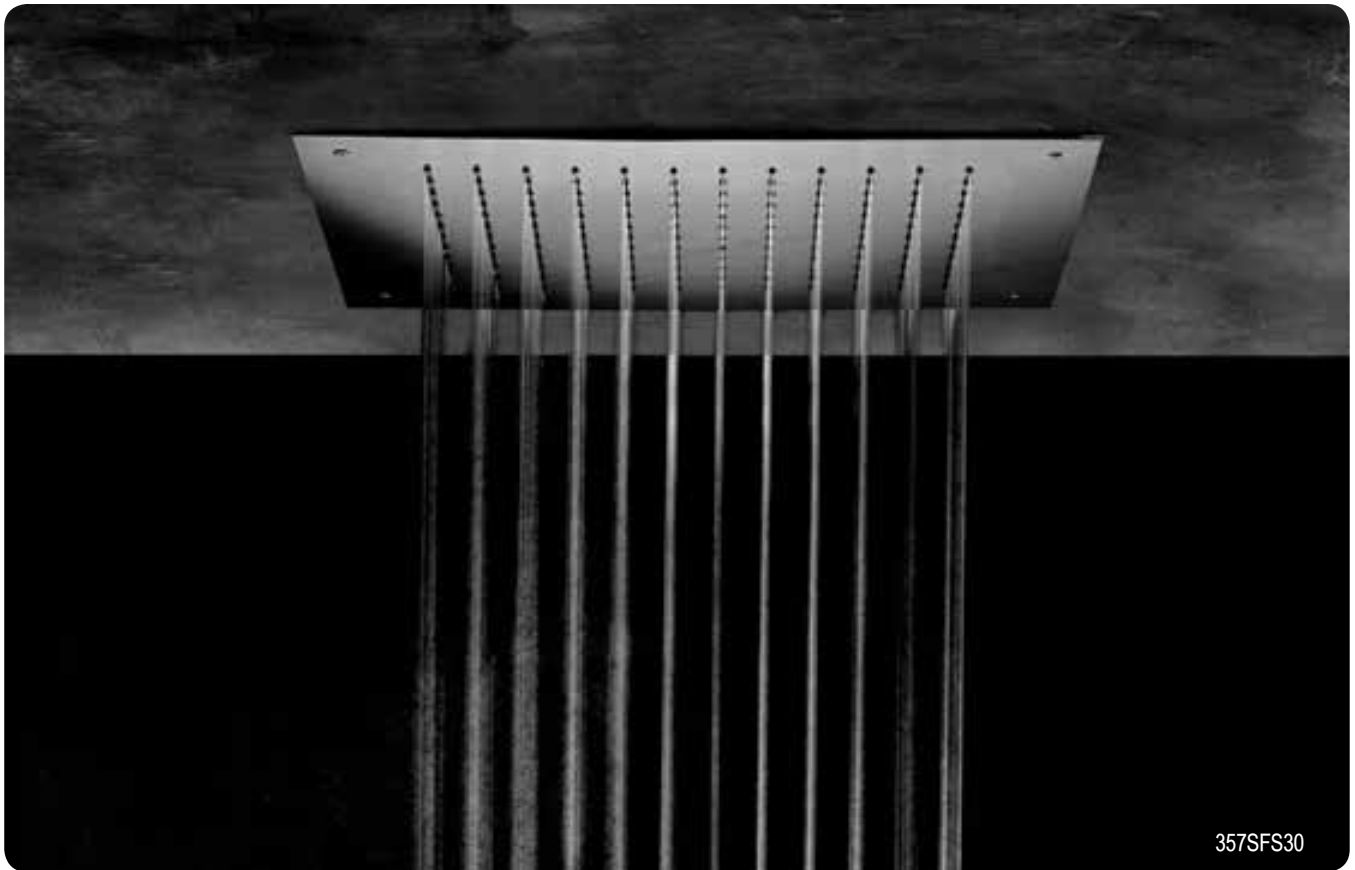

SOFFIONI A SOFFITTO CON TELAIO - CEILING SHOWER HEAD WITH FIXING SET



357SFS30

Soffione a soffitto in Acciaio INOX lucidato a specchio, getti anticalcare, 30x30 cm con getto a pioggia.

Ceiling stainless steel mirror polished shower head, antilimestone jets, 30x30 cm, with rain.

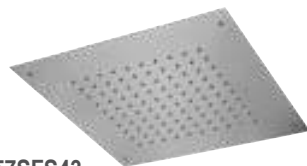

357SFS43

Soffione a soffitto in Acciaio INOX lucidato a specchio, getti anticalcare, 43x43 cm con getto a pioggia.

Ceiling stainless steel mirror polished shower head, antilimestone jets, 43x43 cm, with rain jet.

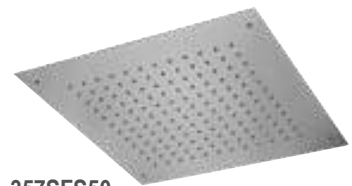

357SFS50

Soffione a soffitto in Acciaio INOX lucidato a specchio, getti anticalcare, 50x50 cm con getto a pioggia.

Ceiling stainless steel mirror polished shower head, antilimestone jets, 50x50 cm, with rain jet.



357SFS43C

Soffione a soffitto in Acciaio INOX lucidato a specchio, getti anticalcare, 43x43 cm, a 2 funzioni: pioggia e cascata.

Ceiling stainless steel mirror polished shower head, antilimestone jets, 43x43 cm, 2 functions: rain and waterfall.



357SFS50C

Soffione a soffitto in Acciaio INOX lucidato a specchio, getti anticalcare, 50x50 cm, a 2 funzioni: pioggia e cascata.

Ceiling stainless steel mirror polished shower head, antilimestone jets, 50x50 cm, 2 functions: rain and waterfall.



357SFS43NC

Soffione a soffitto in Acciaio INOX lucidato a specchio, getti anticalcare, 43x43 cm, a 3 funzioni: pioggia, nebulizzazione (4 uscite) ed 1 getto a cascata.

Ceiling stainless steel mirror polished shower head, antilimestone jets, 43x43 cm, 3 functions: rain jet, nebulization (4 outlet) and waterfall.



357SFS50NC

Soffione a soffitto in Acciaio INOX lucidato a specchio, getti anticalcare, 50x50 cm, a 3 funzioni: pioggia, nebulizzazione (4 uscite) ed 1 getto a cascata.

Ceiling stainless steel mirror polished shower head, antilimestone jets, 50x50 cm, 3 functions: rain, nebulization (4 outlet) and waterfall.



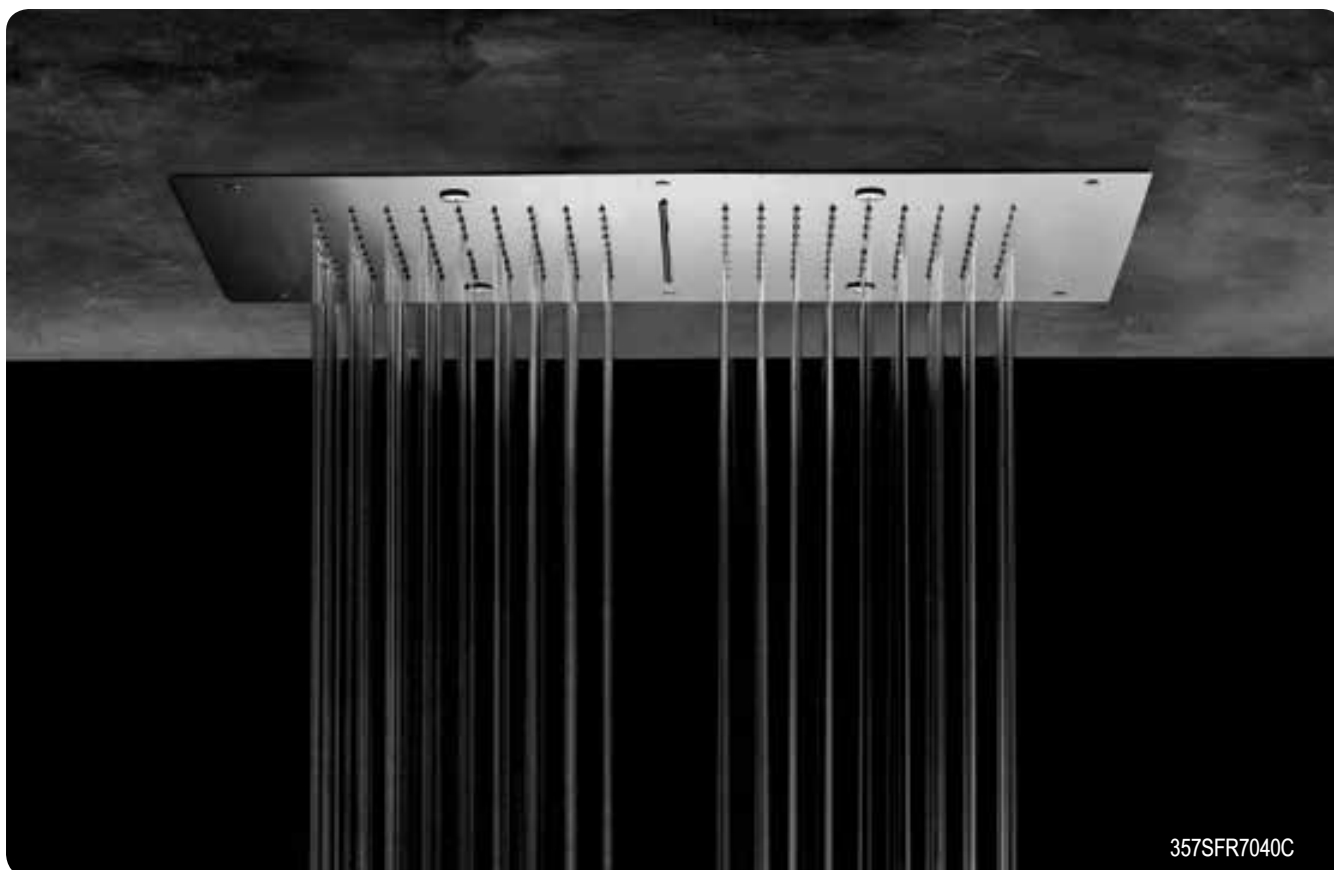

357SFR7040C

BOX INCASSO
BUILT-IN BOXKIT WELLNESS
WELLNESS KITCROMOTERAPIA
COLOR THERAPYSOFFIONI
SHOWER HEADSBOCCHE
SPOUTSPANNELLI DOCCIA
SHOWER PANELSCOLONNE DOCCIA
SHOWER COLUMNSSALISCENDI
SLIDING RAILSDOCCETTE
HAND SHOWERS

SHUT-OFF

BORDO VASCA
DECK BATH MIXERFLESSIBILI DOCCIA
SHOWER FLEXIBLES**357SFR7040**

Soffione a soffitto in Acciaio INOX, getti anticalcare, 70x40 cm, 2 postazioni pioggia.

Ceiling stainless steel mirror polished shower head, antilime scale jets, 70x40 cm, with 2 rain jet workstations.

**357SFR7040C**

Soffione a soffitto in Acciaio INOX, getti anticalcare, 70x40 cm, a 2 funzioni: 2 postazioni pioggia, ed un getto a cascata centrale.

Ceiling stainless steel shower head, antilime scale jets, 70x40 cm, with 2 functions: 2 rain jet workstations and a central waterfall jet.

**357SFR7040NC**

Soffione a soffitto in Acciaio INOX lucidato a specchio, getti anticalcare, 70x40 cm, 3 funzioni: 2 postazioni pioggia, nebulizzazione (4 uscite), ed un getto a cascata centrale.

Ceiling stainless steel shower head, antilime scale jets, 70x40 cm, 3 functions: 2 rain jet workstation, nebulization (4 outlets) and a central waterfall jet.

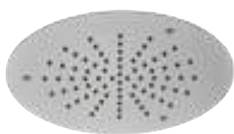
**357SFM30**

Soffione a soffitto in Acciaio INOX lucidato a specchio, Ø30 cm, con getto anticalcare a pioggia.

Ceiling stainless steel mirror polished shower head Ø30 cm, with antilime scale rain jet.

**357SFM40**

Soffione a soffitto in Acciaio INOX lucidato a specchio Ø40 cm, con getto anticalcare a pioggia.

Ceiling stainless steel mirror polished shower head Ø40 cm, with antilime scale rain jet.

**357SFM55**

Soffione a soffitto in Acciaio INOX lucidato a specchio Ø55 cm, con getto anticalcare a pioggia.

Ceiling stainless steel mirror polished shower head Ø55 cm, with antilime scale rain jet.

**357SFM42N**

Soffione a soffitto in Acciaio INOX lucidato a specchio Ø42 cm, con getti anticalcare, a 2 funzioni: pioggia e nebulizzazione (4 uscite).

Ceiling stainless steel mirror polished shower head Ø42 cm, antilime scale jets, with 2 functions: rain and nebulization (4 outlets).

**357SFM55N**

Soffione a soffitto in Acciaio INOX lucidato a specchio Ø55 cm, getti anticalcare, a 2 funzioni: pioggia e nebulizzazione (6 uscite).

Ceiling stainless steel mirror polished shower head Ø55 cm, antilime scale jets, with 2 functions: rain and nebulization (6 outlets).

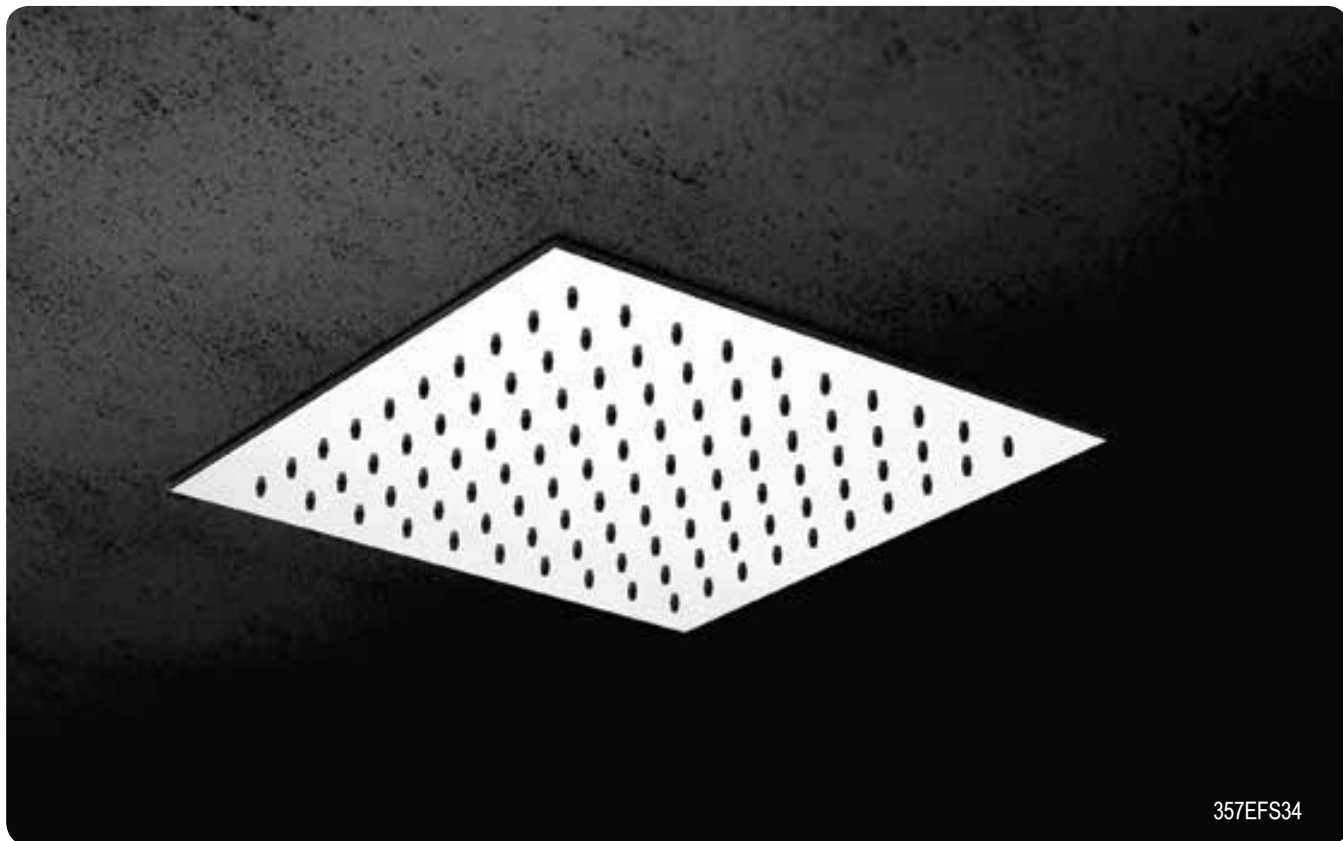

SOFFIONI A SOFFITTO “EASY FIX” - CEILING SHOWER HEAD “EASY FIX”



357EFM34

Soffione doccia EASY FIX in acciaio INOX lucidato a specchio Ø34 cm. Con getti anticalcare. *EASY FIX stainless steel mirror polished shower head Ø34 cm. With antilimestone jets.*



357EFM44

Soffione doccia EASY FIX in acciaio INOX lucidato a specchio Ø44 cm. Con getti anticalcare. *EASY FIX stainless steel mirror polished shower head Ø44 cm. With antilimestone jets.*



357EFS34

Soffione doccia EASY FIX in acciaio INOX lucidato a specchio 34x34 cm. Con getti anticalcare. *EASY FIX stainless steel mirror polished shower head 34x34 cm. With antilimestone jets.*



357EFS44

Soffione doccia EASY FIX in acciaio INOX lucidato a specchio 44x44 cm. Con getti anticalcare. *EASY FIX stainless steel mirror polished shower head 44x44 cm. With antilimestone jets.*

APPLICAZIONE A SOFFITTO “EASY FIX” - “EASY FIX” CEILING APPLICATION

1

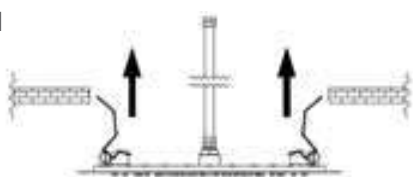

Per questa tipologia di soffione e con questo specifico sistema di fissaggio sono previste quattro molle per ogni soffione. Nell'immagine 1 si evidenzia il primo movimento necessario: caricare due molle vicine tra loro mettendole quasi in posizione verticale rispetto al soffione ed inserirle all'interno del foro precedentemente preparato. Rilasciare le stesse delicatamente.

For this specific shower-head with this specific mounting system, four springs are installed on each head. In picture 1, you shall see the first needed movement to activate them: Spring-load two springs next to each other placing them almost vertically and insert them in the hole in the ceiling; Release them gently;

2

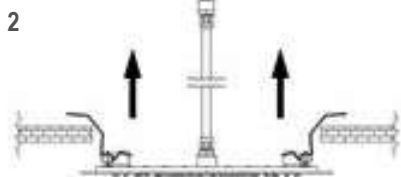

Mantenendo il soffione leggermente inclinato procedere caricando ed inserendo le rimanenti due molle come da immagine 2. *While keeping the shower head slightly inclined, proceed by spring-loading and inserting the two other springs as shown in picture 2.*

3

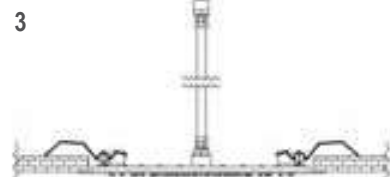

A questo punto rilasciare delicatamente le molle alla loro naturale tensione e, trattenendo esternamente il soffione, accompagnare lo stesso verso il totale appoggio al soffitto come da immagine 3. *Now release the springs back to their natural tension and, while holding the head from outside, guide it to its final position as shown in picture 3.*



350UFMCAX

LINEA MINIMALE IN ACCIAIO INOX STAINLESS STEEL MINIMAL LINE



357UFM20X

Soffione doccia anticalcare ultrapiatto Ø20 cm in acciaio INOX lucidato a specchio.

Ultraslim antilimestone stainless steel mirror polished shower head Ø20 cm.



357UFM25X

Soffione doccia anticalcare ultrapiatto Ø25 cm in acciaio INOX lucidato a specchio.

Ultraslim antilimestone stainless steel mirror polished shower head Ø25 cm.



357UFM30X

Soffione doccia anticalcare ultrapiatto Ø30 cm in acciaio INOX lucidato a specchio.

Ultraslim antilimestone stainless steel mirror polished shower head Ø30 cm.



357UFM40X

Soffione doccia anticalcare ultrapiatto Ø40 cm in acciaio INOX lucidato a specchio.

Ultraslim antilimestone stainless steel mirror polished shower head Ø40 cm.



350UFMX

Soffione doccia anticalcare ultrapiatto 50x20 cm, a parete in acciaio INOX lucidato a specchio.

Ultraslim antilimestone stainless steel mirror polished wall shower head 50x20 cm.



350UFMCAX

Soffione doccia anticalcare ultrapiatto 50x20 cm, a parete in acciaio INOX lucidato a specchio, 2 funzioni: pioggia e cascata.

Ultraslim antilimestone stainless steel mirror polished wall shower head, 2 functions: rain and waterfall, 50x20 cm.



350MMX

Soffione doccia anticalcare 50x20 cm, a parete in acciaio INOX lucidato a specchio.

Stainless antilimestone steel mirror polished wall shower head 50x20 cm.



350MMCAX

Soffione doccia anticalcare 50x20 cm, a parete in acciaio INOX lucidato a specchio, 2 funzioni: pioggia e cascata.

Stainless steel antilimestone mirror polished wall shower head, 2 functions: rain and waterfall, 50x20 cm.

BOX INCASSO
BUILT-IN BOXKIT WELLNESS
WELLNESS KITCROMOTERAPIA
COLOR THERAPYSOFFIONI
SHOWER HEADSBOCCHE
SPOUTSPANNELLI DOCCIA
SHOWER PANELSCOLONNE DOCCIA
SHOWER COLUMNSSALISCENDI
SLIDING RAILSDOCCETTE
HAND SHOWERS

SHUT-OFF

BORDO VASCA
DECK BATH MIXERFLESSIBILI DOCCIA
SHOWER FLEXIBLES



350SSCAX

LINEA QUADRATA IN ACCIAIO INOX STAINLESS STEEL SQUARED LINE



357UFS20X

Soffione doccia anticalcare ultrapiatto 20x20 cm in acciaio INOX lucidato a specchio.
Ultraslim antilimestone stainless steel mirror polished shower head 20x20 cm.



357UFS25X

Soffione doccia anticalcare ultrapiatto 25x25 cm in acciaio INOX lucidato a specchio.
Ultraslim antilimestone stainless steel mirror polished shower head 25x25 cm.



357UFS30X

Soffione doccia anticalcare ultrapiatto 30x30 cm in acciaio INOX lucidato a specchio.
Ultraslim antilimestone stainless steel mirror polished shower head 30x30 cm.



357UFS40X

Soffione doccia anticalcare ultrapiatto 40x40 cm in acciaio INOX lucidato a specchio.
Ultraslim antilimestone stainless steel mirror polished shower head 40x40 cm.



357UFRX

Soffione doccia anticalcare ultrapiatto 33x22 cm in acciaio INOX lucidato a specchio.
Ultraslim antilimestone stainless steel mirror polished shower head 33x22 cm.



350UFX

Soffione doccia anticalcare ultrapiatto 50x22 cm, a parete in acciaio INOX lucidato a specchio.
Ultraslim antilimestone stainless steel mirror polished wall shower head 50x22 cm.



350UFCAX

Soffione doccia anticalcare ultrapiatto 50x22 cm, a parete in acciaio INOX lucidato a specchio, 2 funzioni: getto a pioggia e cascata.
Ultraslim antilimestone stainless steel mirror polished wall shower head, 2 functions: rain and waterfall, 50x22 cm.



350SSX

Soffione doccia anticalcare a parete 50x20 cm, in acciaio INOX lucidato a specchio.
Stainless steel mirror polished wall shower head antilimestone 50x20 cm.



350SSCAX

Soffione doccia anticalcare a parete 50x20 cm, in acciaio INOX lucidato a specchio, 2 funzioni: getto a pioggia e cascata.
Stainless steel mirror polished wall shower head antilimestone, 2 functions: rain and waterfall, 50x20 cm.



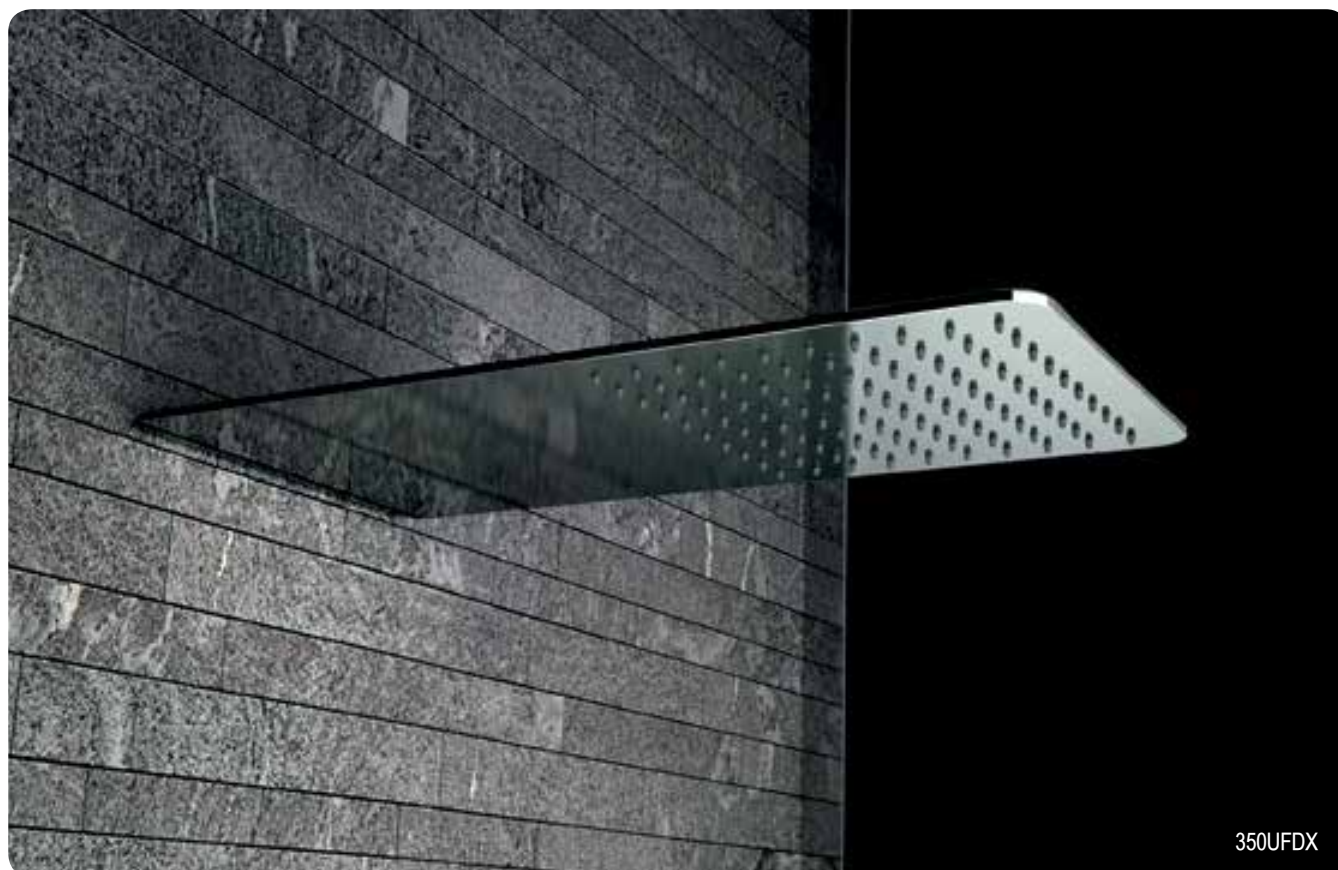

350UFDX

LINEA QUADRATA CON ANGOLI ARROTONDATI IN ACCIAIO INOX STAINLESS STEEL SQUARED LINE WITH ROUND CORNERS



357UFD20X

Soffione doccia quadrato con angoli arrotondati ultrapiatto in Acciaio Inox 20x20 cm lucidato a specchio, con getti in silicone anticalcare.

Squared with rounded corners ultraslim stainless steel mirror polished shower head 20x20 cm, with antilimestone silicon jets.



357UFD25X

Soffione doccia quadrato con angoli arrotondati ultrapiatto in Acciaio Inox 25x25 cm lucidato a specchio, con getti in silicone anticalcare.

Squared with rounded corners ultraslim stainless steel mirror polished shower head 25x25 cm, with antilimestone silicon jets.



357UFD30X

Soffione doccia quadrato con angoli arrotondati ultrapiatto in Acciaio Inox 30x30 cm lucidato a specchio, con getti in silicone anticalcare.

Squared with rounded corners ultraslim stainless steel mirror polished shower head 30x30 cm, with antilimestone silicon jets.



357UFD40X

Soffione doccia quadrato con angoli arrotondati ultrapiatto in Acciaio Inox 40x40 cm lucidato a specchio, con getti in silicone anticalcare.

Squared with rounded corners ultraslim stainless steel mirror polished shower head 40x40 cm, with antilimestone silicon jets.



350UFDX

Soffione doccia ultrapiatto 5mm, 50x22 cm, a parete in acciaio INOX lucidato a specchio, anticalcare.

5 mm ultraslim stainless steel mirror polished wall shower head, 50x22 cm, antilimestone.



350UFDCAx

Soffione doccia anticalcare, ultrapiatto 5mm, 50x22 cm, a parete in acciaio INOX lucidato a specchio, a 2 funzioni: pioggia e cascata.

Antilimestone, 5 mm ultraslim stainless steel mirror polished wall shower head, 2 functions: rain jet and waterfall, 50x22 cm.

BOX INCASSO
BUILT-IN BOXKIT WELLNESS
WELLNESS KITCROMOTERAPIA
COLOR THERAPYSOFFIONI
SHOWER HEADSBOCCHE
SPOUTSPANNELLI DOCCIA
SHOWER PANELSCOLONNE DOCCIA
SHOWER COLUMNSSALISCENDI
SLIDING RAILSDOCCETTE
HAND SHOWERS

SHUT-OFF

BORDO VASCA
DECK BATH MIXERFLESSIBILI DOCCIA
SHOWER FLEXIBLES



SOFFIONI A PARETE MINIMALI
MINIMAL WALL SHOWER HEAD



350XN

Soffione doccia Ø 15 cm, lunghezza 30 cm, a parete in acciaio INOX lucidato a specchio.
Stainless steel mirror polished wall shower head Ø15 cm, lenght 30 cm.



350XS

Soffione doccia 15x15 cm, lunghezza 25 cm, a parete in acciaio INOX lucidato a specchio.
Stainless steel mirror polished wall shower head 15x15 cm, lenght 25 cm, .

TUTTO IN OTTONE ALL IN BRASS

CON OPZIONI DI FINITURA



WITH FINISHING OPTIONS



359SSX

Soffione SQ, tutto in ottone, getti in silicone soffice anticalcare, cm 20x20.
Shower head SQ, all in brass, soft silicon jets, antilimestone, cm 20x20.



359WX

Soffione a pioggia rettangolare, a snodo, 24x14 cm in ottone, getti in silicone anticalcare.
Rectangular shower head with ball-joint, all in brass, 24x14 cm, silicon antilimestone jets.



359SSLX

Soffione a pioggia quadrato piatto, a snodo, 30x30, cm in ottone, getti in silicone anticalcare.
Squared shower head with ball-joint, all in brass 30x30 cm, soft silicon antilimestone jets, with ball-joint.



359SSXLX

Soffione a pioggia quadrato piatto, a snodo, 35x35 cm in ottone, getti in silicone anticalcare.
Square shower head, in brass, 35x35 cm, soft silicon antilimestone jets, with ball-joint.



359MM20X

Soffione doccia minimale piatto in ottone, getti in silicone morbido, anticalcare, Ø 20 cm.
Minimal flat brass antilimestone shower head, soft silicon jets, Ø 20 cm.



359MM30X

Soffione doccia minimale piatto in ottone, getti in silicone morbido, anticalcare, Ø 30 cm.
Minimal flat brass antilimestone shower head, soft silicon jets, Ø 30 cm.



359MMXLX

Soffione a pioggia piatto, in ottone, a snodo Ø 35 cm cromato, getti in silicone anticalcare.
Minimal shower-head, in Brass, with ball-joint, Ø 35 cm, silicon antilimestone jets.



359B20X

Soffione a "Pioggia" piatto, Ø 20 cm, tutto in ottone, funzione raccoglimento acqua per situazioni di bassa pressione.
Shower head "Rain", Ø 20 cm, all in brass, for low pressure situations.



FIN 1

NO

BO

NP

NPO

FIN 2

CFP

BG

DO



359BEX

Soffione a pioggia 30 getti "Bell" tutto in ottone, a snodo.
Shower-head 30 jets "Bell" all in brass, with ball-joint.



BOX INCASSO
BUILT-IN BOX

KIT WELLNESS
WELLNESS KIT

CROMOTERAPIA
COLOR THERAPY

SOFFIONI
SHOWER HEADS

BOCCHE
SPOUTS

PANNELLI DOCCIA
SHOWER PANELS

COLONNE DOCCIA
SHOWER COLUMNS

SALISCENDI
SLIDING RAILS

DOCCETTE
HAND SHOWERS

SHUT-OFF

BORDO VASCA
DECK BATH MIXER

FLESSIBILI DOCCIA
SHOWER FLEXIBLES

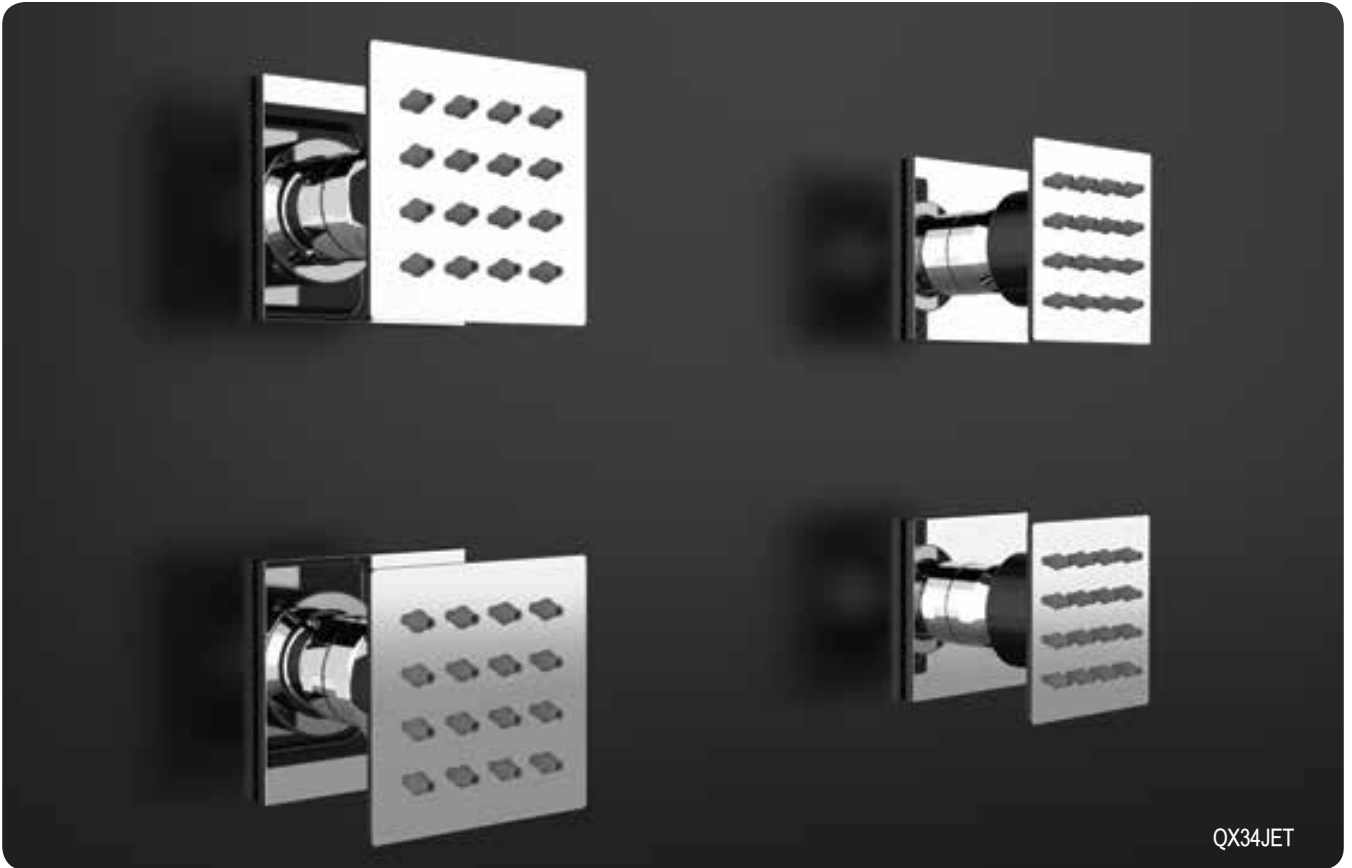

BODY JETS

CON OPZIONI DI FINITURA WITH FINISHING OPTIONS



Q34JET

Body jet 4,2x4,2 cm in ottone per sistema doccia, con ugelli in silicone, anticalcare con snodo.

Body jet 4,2x4,2 cm in brass for shower systems, with spray in silicon, antilimestone, with ball-joint.



N34JET

Body jet Ø4 cm in ottone per sistema doccia, con ugelli in silicone, anticalcare, con snodo.

Body jet Ø4 cm in brass for shower systems, with spray in silicon, antilimestone, with ball-joint.



QX34JETB

Body jet ad incassato 5x5 cm, in acciaio INOX lucidato a specchio per sistema doccia, anticalcare, con snodo.

Built-in body jet 5x5 cm, in stainless steel mirror polished for shower systems, antilimestone, with ball-joint.

FIN 1

NO

BO

NP

NPO

FIN 2

CFP

BG

DO



NX34JET

Body jet Ø5 cm, in acciaio INOX lucidato a specchio per sistema doccia, anticalcare, con snodo.

Body jet Ø5 cm, in stainless steel mirror polished for shower systems, antilimestone, with ball-joint.



QX34JET

Body jet 5x5 cm, in acciaio INOX lucidato a specchio per sistema doccia, anticalcare, con snodo.

Body jet 5x5 cm, in stainless steel mirror polished for shower systems, antilimestone, with ball-joint.



NX34JETB

Body jet ad incassato Ø5 cm, in acciaio INOX lucidato a specchio per sistema doccia, anticalcare, con snodo.

Built-in body jet Ø5 cm, in stainless steel mirror polished for shower systems, antilimestone, with ball-joint.

BOCCHE A PARETE - WALL SPOUTS

CON OPZIONI DI FINITURA



WITH FINISHING OPTIONS

**359ZC**

Soffione doccia in ottone con getto a cascata.

Brass shower head, with waterfall jet.**359NC**

Soffione doccia in ottone con getto a cascata bordi arrotondati.

Brass shower head with rounded corners and waterfall jet.**359XL**

Soffione/bocca a cascata ad L in acciaio INOX lucidato a specchio.

Stainless steel mirror polished "L" waterfall shower head/spout.

FIN 1

NO

BO

NP

NPO

FIN 2

CFP

BG

DO

**359XS**

Soffione/bocca a cascata ad incasso squadrata in acciaio INOX lucidato a specchio.

Squared built-in stainless steel mirror polished waterfall shower head/spout.**359XM**

Soffione/bocca a cascata ad incasso con angoli arrotondati in acciaio INOX lucidato a specchio.

Built-in stainless steel mirror polished waterfall shower head/spout with round corners.

SOFFIONI IN ABS - ABS SHOWER HEADS

**354QIX**

Soffione doccia quadrato con angoli arrotondati in ABS cromato, ultrapiatto, cm 20x20, in ABS cromato con getti in silicone anticalcare.

Chrome plated ABS shower head, squared with rounded corners, ultrathin cm 20x20 with silicon antilimestone jets.**354EC20X**

Soffione a pioggia minimale, in ABS cromato, Ø 20 cm, con getti in silicone anticalcare.

C.p. ABS shower head, rain jet, Ø 20 cm, with antilimestone silicon jets.**356AD20X**

Soffione a pioggia quadrato con angoli arrotondati, in ABS cromato, 20x20 cm, con getti in silicone anticalcare.

C.p. ABS squared with rounded corners shower head, rain jet, 20x20 cm, with antilimestone silicon jets.**356MD20X**

Soffione doccia minimale Ø 20 cm, in ABS lusso, cromato, con getti in silicone anticalcare.

Chrome plated minimal deluxe ABS shower head, Ø 20 cm, with silicon antilimestone jets.**356MD25X**

Soffione doccia minimale Ø 25 cm, in ABS lusso, cromato, con getti in silicone anticalcare.

Chrome plated minimal deluxe ABS shower head, Ø 25 cm, with silicon antilimestone jets.**356MD30X**

Soffione doccia minimale Ø 30 cm, in ABS lusso, cromato, con getti in silicone autopulenti e anticalcare.

Chrome plated minimal deluxe ABS shower head, Ø 30 cm, with silicon antilimestone jets.**356SD20X**

Soffione doccia quadrato 20x20 cm, in ABS lusso, cromato, con getti in silicone anticalcare.

Chrome plated square deluxe ABS shower head, 20x20 cm, with silicon antilimestone jets.**356SD25X**

Soffione doccia quadrato 25x25 cm, in ABS lusso, cromato, con getti in silicone anticalcare.

Chrome plated square deluxe ABS shower head, 25x25 cm, with silicon antilimestone jets.**356SD30X**

Soffione doccia quadrato 30x30 cm, in ABS lusso, cromato, con getti in silicone anticalcare.

*Chrome plated square deluxe ABS shower head, 30x30 cm, with silicon antilimestone jets.*BOX INCASSO
BUILT-IN BOXKIT WELLNESS
WELLNESS KITCROMOTERAPIA
COLOR THERAPYSOFFIONI
SHOWER HEADSBOCCHE
SPOUTSPANNELLI DOCCIA
SHOWER PANELSCOLONNE DOCCIA
SHOWER COLUMNSSALISCENDI
SLIDING RAILSDOCCETTE
HAND SHOWERS

SHUT-OFF

BORDO VASCA
DECK BATH MIXERFLESSIBILI DOCCIA
SHOWER FLEXIBLES

SOFFIONI IN ABS
ABS SHOWER HEADS



356V3X

Soffione a 3 funzioni con tasto centrale per il cambio dei getti: getto pioggia, nebulizzazione e misto, in ABS cromato, Ø 23 cm, con getti in silicone anticalcare. C.p. ABS shower head, 3 functions with central button to change jets: rain, nebulization and mixed, Ø 23 cm, with antilimescale silicon jets.

35315

Soffione a pioggia Ø 15 cm, con getti anticalcare e snodo.

Shower-head "RAIN" Ø 15 cm, with antilimescale jet and ball-joint.

SENZA SCATOLA WITHOUT BOX	CON SCATOLA WITH BOX
35315	35315X

35323

Soffione a pioggia Ø 23 cm, con getti anticalcare e snodo.

Shower-head "RAIN" Ø 23 cm, with antilimescale jet and ball-joint.

SENZA SCATOLA WITHOUT BOX	CON SCATOLA WITH BOX
35323	35323X



354PLX

Soffione a pioggia Ø 16 cm, con getti anticalcare e snodo.

Shower-head "Rain" Ø 16 cm, with antilimescale jet and ball-joint.

351A

Soffione con disco anticalcare, a snodo.

Shower-head with antilimescale jet, with ball-joint.

SENZA SCATOLA WITHOUT BOX	CON SCATOLA WITH BOX
351A	351AX

352

Soffione con disco ostaform, a snodo.

Shower-head with ostaform disc, with ball-joint

SENZA SCATOLA WITHOUT BOX	CON SCATOLA WITH BOX
352	352X



358GR

Soffione cromato e satinato con disco anticalcare a snodo con 4 funzioni, autopulente.

Shower-head in chrome and satin, 4 functions antilimescale jet, with ball-joint, self cleaning.

CON SCATOLA WITH BOX	SENZA SCATOLA WITHOUT BOX
358GR	358GRX

358MO

Soffione cromato con disco anticalcare a snodo con 3 funzioni, autopulente.

Shower-head in chrome, 3 functions, self cleaning.

SENZA SCATOLA WITHOUT BOX	CON SCATOLA WITH BOX
358MO	358MOX

355FO

Soffione con disco anticalcare, autopulente, a snodo con 2 funzioni.

Shower-head with 2 functions, self-cleaning, antilimescale jet, with ball-joint

SENZA SCATOLA WITHOUT BOX	CON SCATOLA WITH BOX
355FO	355FOX

BRACCI DOCCIA - SHOWER ARM

CON OPZIONI DI FINITURA  WITH FINISHING OPTIONS**343L**

Braccio doccia in ottone con rosetta, 1/2Mx1/2M.
Brass tube shower arm, with wall flange, 1/2Mx1/2M.

cm 30 cm 40

**348N**

Braccio doccia "Minimal" in ottone, con rosetta, 1/2Mx1/2M.
Brass shower arm "Minimal" with wall flange, 1/2Mx1/2M.

cm 20 cm 30 cm 40 cm 50

**348S**

Braccio doccia quadrato, completo di rosetta quadrata, completamente in ottone, 1/2Mx1/2M.
Squared shower arm, complete with square wall flange, all in brass, 1/2Mx1/2M.

cm 30 cm 40

**347N**

Braccio doccia da soffitto, serie Minimal, completamente in ottone cromato, 1/2Mx1/2M.
Ceiling shower arm, Minimal serie, completely in chrome plated brass, 1/2Mx1/2M.

cm 10 cm 20 cm 30 cm 40 cm 50

**347S**

Braccio doccia da soffitto quadrato, completamente in ottone, 1/2Mx1/2M.
Squared ceiling shower arm completely in chrome plated brass, 1/2Mx1/2M.

cm 10 cm 20 cm 30 cm 40 cm 50

FIN 1

NO

BO

NP

NPO

FIN 2

CFP

BG

DO

**340**

Braccio doccia con rosetta, e soffione snodato, il tutto in ottone.
Brass shower arm with wall flange and adjustable brass shower head.

cm 20 cm 30

**342**

Braccio doccia in ottone, con rosetta, 1/2Mx1/2M.
Brass tube shower arm, with wall flange, 1/2Mx1/2M.

**342S**

Braccio doccia in ottone, con rosetta, 1/2Mx1/2M, lunghezza cm 30.
Brass tube shower arm, with wall flange, 1/2Mx1/2M, length cm 30.

**344**

Braccio doccia pesante in ottone, cm 20.
Heavy brass shower arm in c.p. brass, length cm 20.

**345**

Braccio doccia lusso cm 20, in ottone.
"Deluxe" shower arm, length cm 20, in c.p. brass.

**346**

Braccio doccia, conico, in ottone, cm 20.
Brass cast shower arm, 1/2, cm 20.

**N348ND**

Braccio doccia Minimal in ottone con rosetta e con deviatore integrato e doppia uscita 1/2 per attacco sia del soffione che del flessibile doccia. 1/2MX1/2MX1/2M.

Shower arm Minimal in c.p. chrome with flange, with integrated diverter with double output 1/2" to connect both the shower head and the shower flexible. 1/2MX1/2MX1/2M.

cm 20 cm 30 cm 40 cm 50

**343**

Braccio doccia in ottone con rosetta, 1/2Mx1/2M.
Brass tube shower arm, with wall flange, 1/2Mx1/2M.

cm 20 cm 30 cm 40

**348Q**

Braccio doccia Q in ottone, con rosetta, 1/2Mx1/2M.

Brass Q shower arm with wall flange, 1/2Mx1/2M.

cm 30 cm 40

BOX INCASSO
BUILT-IN BOXKIT WELLNESS
WELLNESS KITCROMOTERAPIA
COLOR THERAPYSOFFIONI
SHOWER HEADSBOCCHE
SPOUTSPANNELLI DOCCIA
SHOWER PANELSCOLONNE DOCCIA
SHOWER COLUMNSSALISCENDI
SLIDING RAILSDOCCETTE
HAND SHOWERS

SHUT-OFF

BORDO VASCA
DECK BATH MIXERFLESSIBILI DOCCIA
SHOWER FLEXIBLES



350SSCANOX

SOFFIONI INOX IN NERO OPACO - MATT BLACK STAINLESS STEEL SHOWER HEADS



357UFM20NOX
Soffione doccia anticalcare ultrapiatto
Ø20 cm in acciaio INOX.
*Ultraslim antilimestone stainless steel
shower head Ø20 cm.*



357UFM25NOX
Soffione doccia anticalcare ultrapiatto
Ø25 cm in acciaio INOX.
*Ultraslim antilimestone stainless steel
shower head Ø25 cm.*



357UFM30NOX
Soffione doccia anticalcare ultrapiatto
Ø30 cm in acciaio INOX.
*Ultraslim antilimestone stainless steel
shower head Ø30 cm.*



357UFM40NOX
Soffione doccia anticalcare ultrapiatto
Ø40 cm in acciaio INOX.
*Ultraslim antilimestone stainless steel
shower head Ø40 cm.*



357UFS20NOX
Soffione doccia anticalcare ultrapiatto
20x20 cm in acciaio INOX.
*Ultraslim antilimestone stainless
steel shower head 20x20 cm.*



357UFS25NOX
Soffione doccia anticalcare ultrapiatto
25x25 cm in acciaio INOX.
*Ultraslim antilimestone stainless
steel shower head 25x25 cm.*



357UFS30NOX
Soffione doccia anticalcare ultrapiatto
30x30 cm in acciaio INOX.
*Ultraslim antilimestone stainless
steel shower head 30x30 cm.*



357UFS40NOX
Soffione doccia anticalcare ultrapiatto
40x40 cm in acciaio INOX.
*Ultraslim antilimestone stainless
steel shower head 40x40 cm.*



350MMNOX
Soffione doccia anticalcare 50x20 cm, a parete in acciaio INOX.
Stainless antilimestone steel wall shower head 50x20 cm.



350MMCANOX
Soffione doccia anticalcare 50x20 cm, a parete in acciaio INOX, 2 funzioni: a pioggia e cascata.
Stainless steel antilimestone wall shower head, 2 functions: rain and waterfall, 50x20 cm.



**350SSNOX**

Soffione doccia anticalcare a parete 50x20 cm, in acciaio INOX.
Stainless steel wall shower head antilimestone 50x20 cm.

**350SSCANOX**

Soffione doccia anticalcare a parete 50x20 cm, in acciaio INOX, 2 funzioni: getto a pioggia e cascata.
Stainless steel wall shower head antilimestone, 2 functions: rain and waterfall, 50x20 cm.

**350UFMNOX**

Soffione doccia anticalcare ultrapiatto 50x20 cm, a parete in acciaio INOX.
Ultraslim antilimestone stainless steel wall shower head 50x20 cm.

**350UFMCANOX**

Soffione doccia anticalcare ultrapiatto 50x20 cm, a parete in acciaio INOX, 2 funzioni: pioggia e cascata.
Ultraslim antilimestone stainless steel wall shower head, 2 functions: rain and waterfall, 50x20 cm.

**350UFNOX**

Soffione doccia anticalcare ultrapiatto 50x22 cm, a parete in acciaio INOX.
Ultraslim antilimestone stainless steel wall shower head 50x22 cm.

**350UFCANOX**

Soffione doccia anticalcare ultrapiatto 50x22 cm, a parete in acciaio INOX, 2 funzioni: getto a pioggia e cascata.
Ultraslim antilimestone stainless steel wall shower head, 2 functions: rain and waterfall, 50x22 cm.

**357EFM34NO**

Soffione doccia EASY FIX in acciaio INOX Ø34 cm. Con getti anticalcare.
EASY FIX stainless steel shower head Ø34 cm. With antilimestone jets.

**357EFM44NO**

Soffione doccia EASY FIX in acciaio INOX Ø44 cm. Con getti anticalcare.
EASY FIX stainless steel shower head Ø44 cm. With antilimestone jets.

**357EFS34NO**

Soffione doccia EASY FIX in acciaio INOX 34x34 cm. Con getti anticalcare.
EASY FIX stainless steel shower head 34x34 cm. With antilimestone jets.

**357EFS44NO**

Soffione doccia EASY FIX in acciaio INOX 44x44 cm. Con getti anticalcare.
EASY FIX stainless steel shower head 44x44 cm. With antilimestone jets.



APPLICAZIONE A SOFFITTO "EASY FIX" - "EASY FIX" CEILING APPLICATION

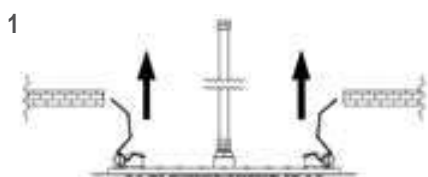

Per questa tipologia di soffione e con questo specifico sistema di fissaggio sono previste quattro molle per ogni soffione.

Nell'immagine 1 si evidenzia il primo movimento necessario: caricare due molle vicine tra loro mettendole quasi in posizione verticale rispetto al soffione ed inserirle all'interno del foro precedentemente preparato. Rilasciare le stesse delicatamente.

For this specific shower-head with this specific mounting system, four springs are installed on each head.

In picture 1, you shall see the first needed movement to activate them:

Spring-load two springs next to each other placing them almost vertically and insert them in the hole in the ceiling;

Release them gently;

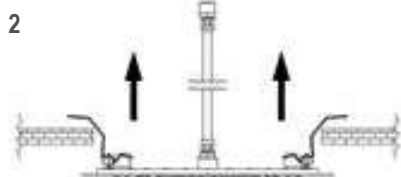

Mantenendo il soffione leggermente inclinato procedere caricando ed inserendo le rimanenti due molle come da immagine 2.

While keeping the shower head slightly inclined, proceed by spring-loading and inserting the two other springs as shown in picture 2.

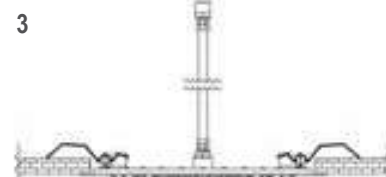

A questo punto rilasciare delicatamente le molle alla loro naturale tensione e, trattenendo esternamente il soffione, accompagnare lo stesso verso il totale appoggio al soffitto come da immagine 3.

Now release the springs back to their natural tension and, while holding the head from outside, guide it to its final position as shown in picture 3.

BOX INCASSO
BUILT-IN BOXKIT WELLNESS
WELLNESS KITCROMOTERAPIA
COLOR THERAPYSOFFIONI
SHOWER HEADSBOCCHE
SPOUTSPANNELLI DOCCIA
SHOWER PANELSCOLONNE DOCCIA
SHOWER COLUMNSSALISCENDI
SLIDING RAILSDOCCETTE
HAND SHOWERS

SHUT-OFF

BORDO VASCA
DECK BATH MIXERFLESSIBILI DOCCIA
SHOWER FLEXIBLES

BOCCE - SPOUTS

BOCCE SPOUTS



La bocche per incasso o bordo vasca sono un utile strumento per personalizzare la zona della vasca da bagno, abbinando l'estetica e la tipologia di getto ai diversi obiettivi dei singoli progetti.

The built-in or deck-bath spouts are a useful tool for customizing the bathtub area, matching the aesthetics and the type of each solution to the different objectives of each project.



BOX INCASSO
BUILT-IN BOX

KIT WELLNESS
WELLNESS KIT

CROMOTERAPIA
COLOR THERAPY

SOFFIONI
SHOWER HEADS

BOCCHE
SPOUTS

PANNELLI DOCCIA
SHOWER PANELS

COLONNE DOCCIA
SHOWER COLUMNS

SALISCENDI
SLIDING RAILS

DOCCETTE
HAND SHOWERS

SHUT-OFF

BORDO VASCA
DECK BATH MIXER

FLESSIBILI DOCCIA
SHOWER FLEXIBLES

BOCCHIE A CASCATA - WATERFALL SPOUTS

CON OPZIONI DI FINITURA  WITH FINISHING OPTIONS



91NC
Bocca incasso cascata con bordi arrotondati, serie Minimal.
Waterfall built-in spout with rounded corners, Minimal serie.



91NCF
Bocca bordo vasca con effetto multigetto ed angoli arrotondati, serie Minimal.
Spout for deck bath/shower multijets effect and rounded corners, Minimal serie.



91UF07
Bocca bordo vasca con getto a cascata.
Spout for deck bath/shower with waterfall jet.



91ZC
Bocca incasso cascata.
Waterfall built-in spout.



91ZCF
Bocca bordo vasca con effetto multigetto.
Spout for deck bath/shower with multijets effect.



91ZCA
Bocca bordo vasca getto a cascata.
Spout for deck bath/shower with waterfall jet.



91QC
Bocca incasso cascata serie Qubika, cm 18.
Qubika cascade built-in spout, cm 18.

FIN 1

NO

BO

NP

NPO

FIN 2

CFP

BG

DO



359XS
Boccal/soffione a cascata ad incasso squadrato in acciaio INOX lucidato a specchio.
Squared built-in stainless steel mirror polished waterfall spout/shower head.



359XM
Boccal/soffione a cascata ad incasso con angoli arrotondati in acciaio INOX lucidato a specchio.
Built-in stainless steel mirror polished waterfall spout/shower head with round corners.



359XL
Boccal/soffione a cascata ad L in acciaio INOX lucidato a specchio.
Stainless steel mirror polished "L" waterfall spout/shower head.

BOCCHIE INCASSO - BUILT-IN SPOUTS

CON OPZIONI DI FINITURA  WITH FINISHING OPTIONS



91EY
Bocca incasso cm 18, serie Energy.
Energy built-in spout, cm 18.



91Q
Bocca incasso serie Qubika, cm 18.
Qubika built-in spout cm 18.



91I
Bocca incasso cm 18, serie Infinity.
Infinity built-in spout, cm 18.



91DR
Bocca incasso serie Dream, cm 18.
Dream built-in spout, cm 18.

91EYL
Lunghezza cm 23.
Length cm 23.

91QL
Lunghezza cm 23.
Length cm 23.

91IL
Lunghezza cm 23.
Length cm 23.

91DL
Lunghezza cm 23.
Length cm 23.



91X
Bocca incasso, serie X Style, 16,5 cm.
Built-in spout, X Style serie, 16,5 cm.



91L
Bocca incasso cm 18, serie Class Line.
Class Line built-in spout, cm 18.



91QD
Bocca incasso serie Qubika, cm 18, con deviatore integrato.
Qubika built-in spout, with integrated diverter.

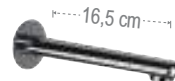

91V
Bocca incasso, serie Vanity, 16,5 cm.
Built-in spout, Vanity serie, 16,5 cm.

91XL
Lunghezza cm 19.
Length cm 19.

91LL
Lunghezza cm 23.
Length cm 23.



91M
Bocca incasso cm 18, serie Minimal.
Minimal built-in spout, cm 18.



91MD
Bocca incasso serie Minimal, cm 18, con deviatore integrato.
Minimal built-in spout cm 18, with diverter.

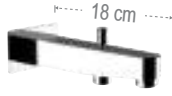

91LD
Bocca incasso cm 18 con deviatore.
Built-in spout cm 18 with diverter.



91S
Bocca incasso quadrata cm 18, serie Square.
Square built-in spout, cm 18.



91SD
Bocca incasso quadrata cm 18, serie Square con deviatore.
Square built-in spout cm 18, with diverter.

FIN 1 NO BO NP NPO FIN 2 CFP BG DO



91NR
Bocca incasso cm 18, serie Minimal Color.
Minimal Color built-in spout, cm 18.



91D
Bocca incasso vasca-doccia, con deviatore integrato.
Built-in spout for bath-shower, with diverter.



91QR
Bocca incasso con luce led serie Q Color.
Built-in spout with led light Q Color Serie.



91Q2
Bocca incasso serie Q.
Built-in spout Q Serie.



91N2
Bocca incasso cm 18, serie Minimal.
Minimal built-in spout, cm 18.



91
Bocca incasso vasca-doccia.
Built-in spout for bath-shower.

BOX INCASSO
BUILT-IN BOX

KIT WELLNESS
WELLNESS KIT

CROMOTERAPIA
COLOR THERAPY

SOFFIONI
SHOWER HEADS

BOCCHIE
SPOUTS

PANNELLI DOCCIA
SHOWER PANELS

COLONNE DOCCIA
SHOWER COLUMNS

SALISCENDI
SLIDING RAILS

DOCETTE
HAND SHOWERS

SHUT-OFF

BORDO VASCA
DECK BATH MIXER

FLESSIBILI DOCCIA
SHOWER FLEXIBLES

BOCCE A SOFFITTO - CEILING SPOUTS

CON OPZIONI DI FINITURA  WITH FINISHING OPTIONS



91VNR
 Bocca da soffitto in ottone
 lunghezza 166 cm, con
 dispositivo color.
*Ceiling spout in chrome
 plated brass cm 166, with
 color device.*



91VLNR
 Bocca da soffitto in ottone
 lunghezza 181 cm, con
 dispositivo color.
*Ceiling spout in chrome
 plated brass cm 181, with
 color device.*



91VN2
 Bocca da soffitto in ottone
 lunghezza 166 cm.
*Ceiling spout in chrome
 plated brass cm 166.*



91VLN2
 Bocca da soffitto in ottone
 lunghezza 181 cm.
*Ceiling spout in chrome
 plated brass cm 181.*

FIN 1

NO

BO

NP

NPO

FIN 2

CFP

BG

DO



91VN2 (FIN1 - BO)

FLESSIBILI DOCCIA
SHOWER FLEXIBLESBORDO VASCA
DECK BATH MIXER

SHUT-OFF

DOCCETTE
HAND SHOWERSSALISCENDI
SLIDING RAILSCOLONNE DOCCIA
SHOWER COLUMNSPANNELLI DOCCIA
SHOWER PANELSBOCCHE
SPOUTSSOFFIONI
SHOWER HEADSCROMOTERAPIA
COLOR THERAPYKIT WELLNESS
WELLNESS KITBOX INCASSO
BUILT-IN BOX

PANNELLI DOCCIA SHOWER PANELS



I pannelli doccia sono soluzioni complete per l'interno doccia che integrano tutte le funzioni nell'eleganza di un unico elemento. Disponibili, a seconda del modello, con miscelazione tradizionale e termostatica e con i comfort aggiuntivi di getto a cascata e body-jets (verificare le specifiche tecniche dei singoli articoli).

The shower panels are complete solutions for the shower interior that integrate all the functions within the elegance of a single element. Available, depending on the model, with traditional and thermostatic mixing and with the additional comforts of waterfall jet and body-jets (check the technical specifications of the individual items).

BOX INCASSO
BUILT-IN BOXKIT WELLNESS
WELLNESS KITCROMOTERAPIA
COLOR THERAPYSOFFIONI
SHOWER HEADSBOCCHE
SPOUTSPANNELLI DOCCIA
SHOWER PANELSCOLONNE DOCCIA
SHOWER COLUMNSSALISCENDI
SLIDING RAILSDOCCETTE
HAND SHOWERS

SHUT-OFF

BORDO VASCA
DECK BATH MIXERFLESSIBILI DOCCIA
SHOWER FLEXIBLES

PANNELLI DOCCIA - SHOWER PANELS



330QM20

Pannello doccia a parete, monocomando con deviatore a 2 vie, in acciaio INOX lucidato a specchio, getto a pioggia anticalcare, doccetta anticalcare in ABS cromato, flessibile in PVC da 150 cm.

Stainless steel mirror polished wall mounted shower panel, single lever with 2 ways diverter, rain jet with antilime system, c.p. ABS handshower with antilime system, PVC flexible hose 150 cm.



330QM20J

Pannello doccia a parete, monocomando con deviatore a 3 vie, in acciaio INOX lucidato a specchio, getto a pioggia anticalcare, body jets anticalcare, doccetta anticalcare in ABS cromato, flessibile in PVC da 150 cm.

Stainless steel mirror polished wall mounted shower panel, single lever with 3 ways diverter, rain jet with antilime system, antilime body jets, c.p. ABS handshower with antilime system, PVC flexible hose 150 cm.



330QM20JC

Pannello doccia a parete, monocomando con deviatore a 4 vie, in acciaio INOX lucidato a specchio, getto a pioggia anticalcare e getto a cascata, body jets anticalcare, doccetta anticalcare in ABS cromato, flessibile in PVC da 150 cm.

Stainless steel mirror polished wall mounted shower panel, single lever with 4 ways diverter, rain jet with antilime system, waterfall jet, antilime body jets, c.p. ABS handshower with antilime system, PVC flexible hose 150 cm.

PANNELLI DOCCIA AD INCASSO - BUILT-IN SHOWER PANELS

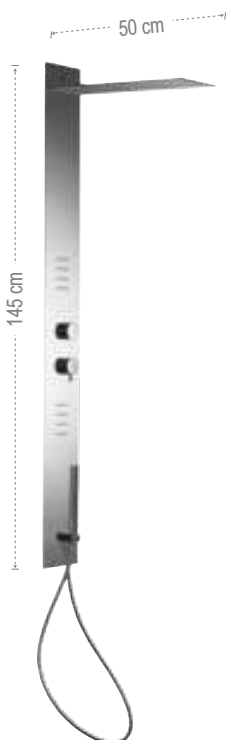

330QI15J

Pannello doccia ad incasso, monocomando con deviatore a 3 vie, in acciaio INOX lucidato a specchio, getto a pioggia anticalcare, body jets anticalcare, doccetta anticalcare in ABS cromato, flessibile in PVC da 150 cm.

Stainless steel mirror polished wall mounted shower panel, single lever with 3 ways diverter, rain jet with antilime system, antilime system body jets, c.p. ABS handshower with antilime system, PVC flexible hose 150 cm.

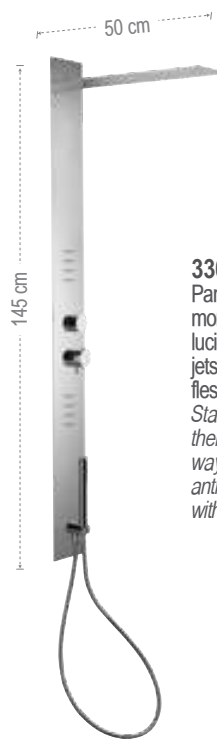

330QIT15J

Pannello doccia ad incasso termostatico, monocomando con deviatore a 3 vie, in acciaio INOX lucidato a specchio, getto a pioggia anticalcare, body jets anticalcare, doccetta anticalcare in ABS cromato, flessibile in PVC da 150 cm.

Stainless steel mirror polished wall mounted thermostatic shower panel, single lever with 3 ways diverter, rain jet with antilime system, antilime system body jets, c.p. ABS handshower with antilime system, PVC flexible hose 150 cm.



PANNELLI DOCCIA TERMOSTATICI - THERMOSTATIC SHOWER PANELS

**330QMT20**

Pannello doccia a parete termostatico coassiale, monocomando con deviatore a 2 vie, in acciaio INOX lucidato a specchio, getto a pioggia anticalcare, doccetta anticalcare in ABS cromato, flessibile in PVC da 150 cm.

Stainless steel mirror polished wall mounted thermostatic coaxial shower panel, single lever with 2 ways diverter, rain jet with antilime system, c.p. ABS handshower with antilime system, PVC flexible hose 150 cm.

**330QMT20J**

Pannello doccia a parete termostatico, monocomando con deviatore a 3 vie, in acciaio INOX lucidato a specchio, getto a pioggia anticalcare, body jets anticalcare, doccetta anticalcare in ABS cromato, flessibile in PVC da 150 cm.

Stainless steel mirror polished wall mounted thermostatic shower panel, single lever with 3 ways diverter, rain jet with antilime system, antilime system body jets, c.p. ABS handshower with antilime system, PVC flexible hose 150 cm.

**330QMT20JC**

Pannello doccia a parete termostatico, monocomando con deviatore a 4 vie, in acciaio INOX lucidato a specchio, getto a pioggia anticalcare e getto a cascata, body jets anticalcare, doccetta anticalcare in ABS cromato, flessibile in PVC da 150 cm.

Stainless steel mirror polished wall mounted thermostatic shower panel, single lever with 4 ways diverter, rain jet with antilime system, waterfall jet, antilime system body jets, c.p. ABS handshower with antilime system, PVC flexible hose 150 cm.

**330QIT15JC**

Pannello doccia ad incasso termostatico, monocomando con deviatore a 4 vie, in acciaio INOX lucidato a specchio, getto a pioggia anticalcare, getto a cascata, body jets anticalcare, doccetta anticalcare in ABS cromato, flessibile in PVC da 150 cm.

Stainless steel mirror polished wall mounted thermostatic shower panel, single lever with 4 ways diverter, rain jet with antilime system, waterfall jet, antilime system body jets, c.p. ABS handshower with antilime system, PVC flexible hose 150 cm.

BOX INCASSO
BUILT-IN BOXKIT WELLNESS
WELLNESS KITCROMOTERAPIA
COLOR THERAPYSOFFIONI
SHOWER HEADSBOCCHE
SPOUTSPANNELLI DOCCIA
SHOWER PANELSCOLONNE DOCCIA
SHOWER COLUMNSSALISCENDI
SLIDING RAILSDOCCETTE
HAND SHOWERS

SHUT-OFF

BORDO VASCA
DECK BATH MIXERFLESSIBILI DOCCIA
SHOWER FLEXIBLES

COLONNE DOCCIA - SHOWER COLUMNS

COLONNE DOCCIA SHOWER COLUMNS



La colonna doccia è una soluzione pratica e versatile che permette di godere di tutta la comodità di un soffione e di una doccia senza la necessità di parti ad incasso. Disponibili con miscelazione tradizionale, termostatica o con l'attacco per un miscelatore esterno, le colonne doccia sono proposte in un'ampia gamma di varianti per poter sempre scegliere il design e le funzioni che meglio soddisfano le vostre esigenze.

The shower column is a practical and versatile solution that allows you to enjoy all the convenience of a shower head and hand shower without the need for recessed parts. Available with traditional, thermostatic mixing or with the connection for an external mixer, the shower columns are offered in a wide range of variants so that you can always choose the design and functions that best meet your needs.



BOX INCASSO
BUILT-IN BOX

KIT WELLNESS
WELLNESS KIT

CROMOTERAPIA
COLOR THERAPY

SOFFIONI
SHOWER HEADS

BOCCHE
SPOUTS

PANNELLI DOCCIA
SHOWER PANELS

COLONNE DOCCIA
SHOWER COLUMNS

SALISCENDI
SLIDING RAILS

DOCCETTE
HAND SHOWERS

SHUT-OFF

BORDO VASCA
DECK BATH MIXER

FLESSIBILI DOCCIA
SHOWER FLEXIBLES

COLONNE DOCCIA A 3 VIE 3 WAYS SHOWER COLUMN

CON OPZIONI DI FINITURA WITH FINISHING OPTIONS



L34X7MMM20
Set doccia composto da: miscelatore esterno con deviatore vasca/doccia, soffione in ottone Ø 20 cm 359MM20X, colonna doccia con fissaggio superiore regolabile in altezza 329X, doccetta minimale in ottone, 1 funzione 317MM, flessibile 150 cm.
Shower set including: exposed mixer with bath/shower diverter, brass shower head Ø 20 cm 359MM20X, shower column with height-adjustable upper fixing 329X, 1-function brass hand shower 317MM, 150 cm flexible hose.



EY34X7SS9SS
Set doccia composto da: miscelatore esterno con deviatore vasca/doccia, soffione in ottone 20x20cm 359SSX, colonna doccia con fissaggio superiore regolabile in altezza 329X, doccetta quadrata in ottone a 1 funzione 317SS, flessibile 150 cm.
Shower set including: exposed mixer with bath/shower diverter, brass shower head 20x20cm 359SSX, shower column with height-adjustable upper fixing 329X, 1-function brass square hand shower 317SS, 150 cm flexible hose.

FIN 1

 NO
 BO
 NP
 NPO

FIN 2

 CFP
 BG
 DO



W34AEC20
Set doccia composto da: miscelatore esterno con deviatore vasca/doccia, soffione in abs Ø 20cm 354EC20X, colonna doccia in ottone telescopica, altezza asta regolabile 329A, doccetta in abs a 4 funzioni 319MO, flessibile 150 cm.
Shower set including: exposed mixer with bath/shower diverter, abs Ø 20 cm shower head 354EC20X, telescopic brass shower column, with height-adjustable rod 329A, 4-function abs hand shower 319MO, 150 cm flexible hose.



W34A8MPEC20
Set doccia composto da: miscelatore esterno con deviatore vasca/doccia, soffione in abs Ø 20cm 354EC20X, colonna doccia in ottone telescopica, altezza asta regolabile 329A, doccetta in abs con 4 funzioni 318MP, flessibile 150 cm.
Shower set including: exposed mixer with bath/shower diverter, abs Ø 20 cm shower head 354EC20X, telescopic brass shower column, with height-adjustable rod 329A, 4-function abs hand shower 318MP, 150 cm flexible hose.

**EY34AEC20**

Set doccia composto da: miscelatore esterno con deviatore vasca/doccia, soffione in abs Ø 20cm 354EC20X, colonna doccia in ottone telescopica, altezza asta regolabile 329A, doccetta in abs con 4 funzioni 318MP, flessibile 150 cm.

Shower set including: exposed mixer with bath/shower diverter, abs Ø 20 cm shower head 354EC20X, telescopic brass shower column, with height-adjustable rod 329A, 4-function abs hand shower 318MP, 150 cm flexible hose.

**EY34ASD20**

Set doccia composto da: miscelatore esterno con deviatore vasca/doccia, soffione 20x20 cm in abs 356SD20X, colonna doccia in ottone telescopica, altezza asta regolabile 329A, doccetta in abs con 4 funzioni 318CP, flessibile 150 cm.

Shower set including: exposed mixer with bath/shower diverter, abs 20x20 cm shower head 356SD20X, telescopic brass shower column, with height-adjustable rod 329A, 4-function abs hand shower 318CP, 150 cm flexible hose.

EY34ASD25

con soffione da 25x25 cm.
with shower head 25x25 cm.

EY34ASD30

con soffione da 30x30 cm.
with shower head 30x30 cm.

**L34AMD20**

Set doccia composto da: miscelatore esterno con deviatore vasca/doccia, soffione in abs Ø 20 cm 356MD20X, colonna doccia in ottone telescopica, altezza asta regolabile 329A, doccetta in abs a 4 funzioni 319MO, flessibile 150 cm.

Shower set including: external mixer with bath/shower diverter, abs shower head Ø 20cm 356MD20X, telescopic brass shower column, height-adjustable rod 329A, 4-functions handshower in abs 319MO, 150 cm flexible hose.

L34AMD25

con soffione da Ø25 cm.
with shower head Ø25 cm.

L34AMD30

con soffione da Ø30 cm.
with shower head Ø30 cm.

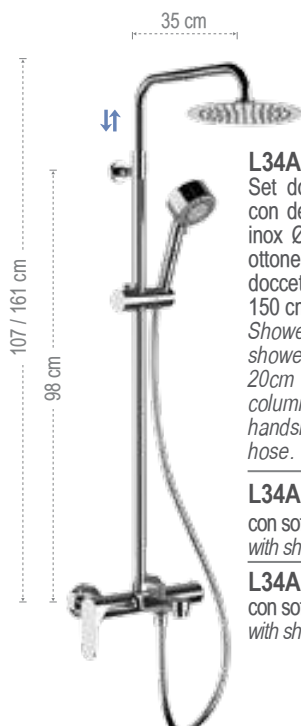
**L34AUFM20**

Set doccia composto da: miscelatore esterno con deviatore vasca/doccia, soffione in acciaio inox Ø 20 cm 357UFM20X, colonna doccia in ottone telescopica, altezza asta regolabile 329A, doccetta in abs a 4 funzioni 319MO, flessibile 150 cm.

Shower set including: external mixer with bath/shower diverter, stainless steel shower head Ø 20cm 357UFM20X, telescopic brass shower column, height-adjustable rod 329A, 4-functions handshower in abs 319MO, 150 cm flexible hose.

L34AUFM25

con soffione da Ø25 cm.
with shower head Ø25 cm.

L34AUFM30

con soffione da Ø30 cm.
with shower head Ø30 cm.

BOX INCASSO
BUILT-IN BOXKIT WELLNESS
WELLNESS KITCROMOTERAPIA
COLOR THERAPYSOFFIONI
SHOWER HEADSBOCCHE
SPOUTSPANNELLI DOCCIA
SHOWER PANELSCOLONNE DOCCIA
SHOWER COLUMNSSALISCENDI
SLIDING RAILSDOCCETTE
HAND SHOWERS

SHUT-OFF

BORDO VASCA
DECK BATH MIXERFLESSIBILI DOCCIA
SHOWER FLEXIBLES



35 cm

107 / 161 cm

98 cm

D34AAD20
 Set doccia composto da: miscelatore esterno con deviatore vasca/doccia, soffione in abs 20x20cm con angoli arrotondati 356AD20X, colonna doccia in ottone telescopica, altezza asta regolabile 329A, doccetta in abs a 4 funzioni 319MO, flessibile 150 cm.
Shower set including: exposed mixer with bath/shower diverter, abs 20x20 cm shower head with rounded corners 356AD20X, telescopic brass shower column, with height-adjustable rod 329A, 4-function abs hand shower 319MO, 150 cm flexible hose.

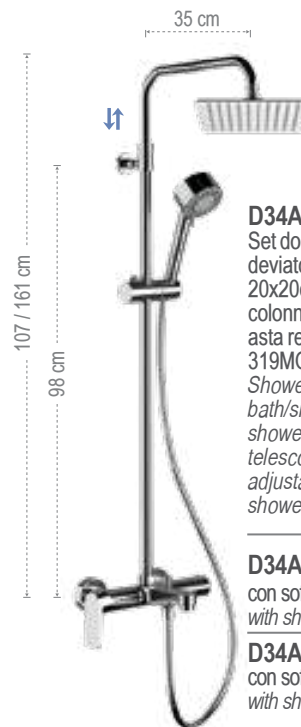
35 cm

107 / 161 cm

98 cm

D34AUF20
 Set doccia composto da: miscelatore esterno con deviatore vasca/doccia, soffione in acciaio inox 20x20cm con angoli arrotondati 357UFD20X, colonna doccia in ottone telescopica, altezza asta regolabile 329A, doccetta in abs a 4 funzioni 319MO, flessibile 150 cm.
Shower set including: exposed mixer with bath/shower diverter, stainless steel 20x20 cm shower head with rounded corners 357UFD20X, telescopic brass shower column, with height-adjustable rod 329A, 4-function abs hand shower 319MO, 150 cm flexible hose.

D34AUF25
 con soffione da 25x25 cm.
 with shower head 25x25 cm.

D34AUF30
 con soffione da 30x30 cm.
 with shower head 30x30 cm.





35 cm

107 / 161 cm

98 cm

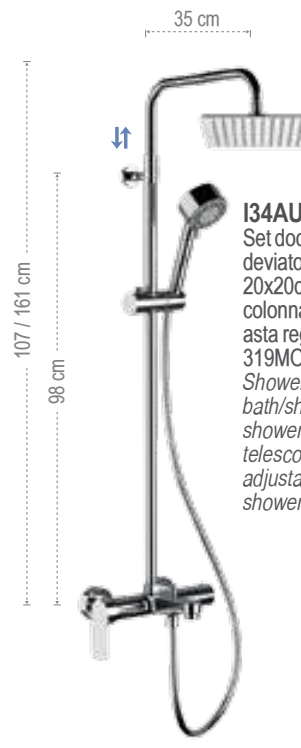
I34AAD20
 Set doccia composto da: miscelatore esterno con deviatore vasca/doccia, soffione in abs 20x20cm con angoli arrotondati 356AD20X, colonna doccia in ottone telescopica, altezza asta regolabile 329A, doccetta in abs a 4 funzioni 319MO, flessibile 150 cm.
Shower set including: exposed mixer with bath/shower diverter, abs 20x20 cm shower head with rounded corners 356AD20X, telescopic brass shower column, with height-adjustable rod 329A, 4-function abs hand shower 319MO, 150 cm flexible hose.





35 cm

107 / 161 cm

98 cm

I34AUF20
 Set doccia composto da: miscelatore esterno con deviatore vasca/doccia, soffione in acciaio inox 20x20cm con angoli arrotondati 357UFD20X, colonna doccia in ottone telescopica, altezza asta regolabile 329A, doccetta in abs a 4 funzioni 319MO, flessibile 150 cm.
Shower set including: exposed mixer with bath/shower diverter, stainless steel 20x20 cm shower head with rounded corners 357UFD20X, telescopic brass shower column, with height-adjustable rod 329A, 4-function abs hand shower 319MO, 150 cm flexible hose.





D34AAD20

BOX INCASSO
BUILT-IN BOXKIT WELLNESS
WELLNESS KITCROMOTERAPIA
COLOR THERAPYSOFFIONI
SHOWER HEADSBOCCHE
SPOUTSPANNELLI DOCCIA
SHOWER PANELSCOLONNE DOCCIA
SHOWER COLUMNSSALISCENDI
SLIDING RAILSDOCCETTE
HAND SHOWERS

SHUT-OFF

BORDO VASCA
DECK BATH MIXERFLESSIBILI DOCCIA
SHOWER FLEXIBLES

COLONNE DOCCIA TERMOSTATICHE MINIMALI MINIMAL THERMOSTATIC SHOWER COLUMN

CON OPZIONI DI FINITURA



WITH FINISHING OPTIONS

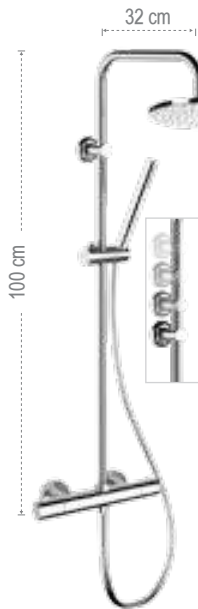

EQ32X7MMM20

Set doccia composto da: miscelatore termostatico esterno con deviatore, soffione in ottone Ø 20 cm 359MM20X, colonna doccia con fissaggio superiore regolabile in altezza 329X, doccetta minimale in ottone, 1 funzione 317MM, flessibile 150 cm.

Shower set including: exposed thermostatic mixer with diverter, brass shower head Ø 20 cm 359MM20X, shower column with height-adjustable upper fixing 329X, 1-function brass hand shower 317MM, 150 cm flexible hose.

EQ32X7MMM30

Con soffione in ottone Ø30 cm.
With brass shower head Ø30 cm.

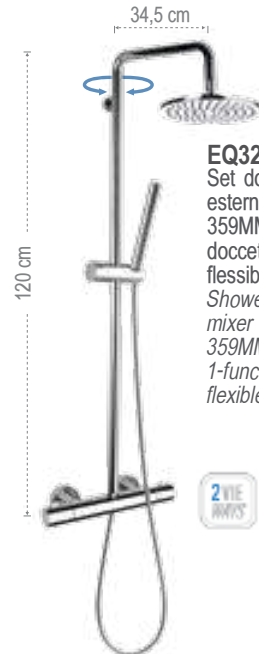

EQ32U

Set doccia composto da: miscelatore termostatico esterno con deviatore, soffione in ottone Ø 20 cm 359MM20X, colonna doccia girevole in ottone 329U, doccetta minimale in ottone, 1 funzione 317MM, flessibile 150 cm.

Shower set including: exposed thermostatic mixer with diverter, brass shower head Ø 20 cm 359MM20X, brass swivel shower column 329U, 1-function brass hand shower 317MM, 150 cm flexible hose.



FIN 1

NO

BO

NP

NPO

FIN 2

CFP

BG

DO

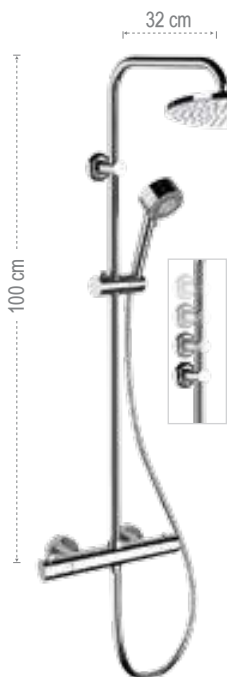

EQ32XMD20

Set doccia composto da: miscelatore termostatico esterno con deviatore, soffione in abs Ø 20 cm 356MD20X, colonna doccia con fissaggio superiore regolabile in altezza 329X, doccetta in abs a 4 funzioni 319MO, flessibile 150 cm.

Shower set including: exposed thermostatic mixer with diverter, abs Ø 20 cm shower head 356MD20X, shower column with height-adjustable upper fixing 329X, 4-function abs hand shower 319MO, 150 cm flexible hose.



EQ32XEC20

Set doccia composto da: miscelatore termostatico esterno con deviatore, soffione in abs Ø 20cm 354EC20X, colonna doccia con fissaggio superiore regolabile in altezza 329X, doccetta in abs a 4 funzioni 319MO, flessibile 150 cm.

Shower set including: exposed thermostatic mixer with diverter, abs Ø 20 cm shower head 354EC20X, shower column with height-adjustable upper fixing 329X, 4-function abs hand shower 319MO, 150 cm flexible hose.

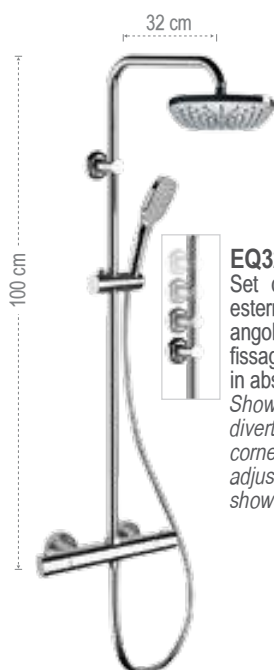

**EQ32X8CPAD20**

Set doccia composto da: miscelatore termostatico esterno con deviatore, soffione in abs 20x20cm con angoli arrotondati 356AD20X, colonna doccia con fissaggio superiore regolabile in altezza 329X, doccetta in abs con 4 funzioni 318CP, flessibile 150 cm.

Shower set including: exposed thermostatic mixer with diverter, abs 20x20 cm shower head with rounded corners 356AD20X, shower column with height-adjustable upper fixing 329X, 4-function abs hand shower 318CP, 150 cm flexible hose.



Set doccia composto da: miscelatore termostatico esterno con deviatore, soffione in abs 356MD20X, colonna doccia con fissaggio superiore regolabile in altezza 329X, doccetta in abs con 4 funzioni 318MP, flessibile 150 cm.

Shower set including: exposed thermostatic mixer with diverter, abs shower head 356MD20X, shower column with height-adjustable upper fixing 329X, 4-function abs hand shower 318MP, 150 cm flexible hose.

EQ32X8MPMD20

soffione Ø 20 cm.
shower head Ø 20 cm.

EQ32X8MPMD25

soffione Ø 25 cm.
shower head Ø 25 cm.

EQ32X8MPMD30

soffione Ø 30 cm.
shower head Ø 30 cm.

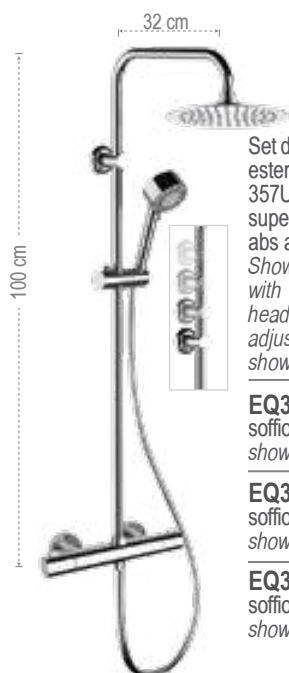

Set doccia composto da: miscelatore termostatico esterno con deviatore, soffione in acciaio inox 357UFM20X, colonna doccia con fissaggio superiore regolabile in altezza 329X, doccetta in abs a 4 funzioni 319MO, flessibile 150 cm.

Shower set including: exposed thermostatic mixer with diverter, stainless steel Ø 20cm shower head 357UFM20X, shower column with height-adjustable upper fixing 329X, 4-function abs hand shower 319MO, 150 cm flexible hose.

EQ32XUFM20

soffione Ø 20 cm.
shower head Ø 20 cm.

EQ32XUFM25

soffione Ø 25 cm.
shower head Ø 25 cm.

EQ32XUFM30

soffione Ø 30 cm.
shower head Ø 30 cm.

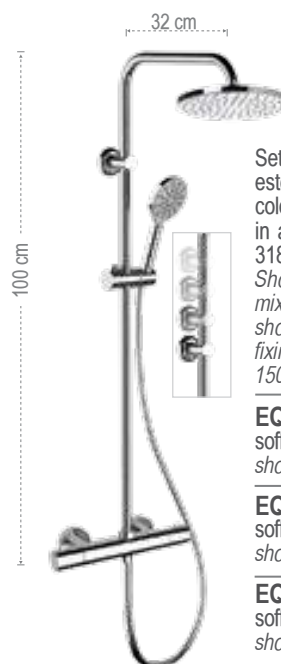

Set doccia composto da: miscelatore termostatico esterno con deviatore, soffione in abs 356MD20X, colonna doccia con fissaggio superiore regolabile in altezza 329X, doccetta in abs con 4 funzioni 318MP, flessibile 150 cm.

Shower set including: exposed thermostatic mixer with diverter, abs shower head 356MD20X, shower column with height-adjustable upper fixing 329X, 4-function abs hand shower 318MP, 150 cm flexible hose.

EQ32X8MPMD20

soffione Ø 20 cm.
shower head Ø 20 cm.

EQ32X8MPMD25

soffione Ø 25 cm.
shower head Ø 25 cm.

EQ32X8MPMD30

soffione Ø 30 cm.
shower head Ø 30 cm.

BOX INCASSO
BUILT-IN BOXKIT WELLNESS
WELLNESS KITCROMOTERAPIA
COLOR THERAPYSOFFIONI
SHOWER HEADSBOCCHE
SPOUTSPANNELLI DOCCIA
SHOWER PANELSCOLONNE DOCCIA
SHOWER COLUMNSSALISCENDI
SLIDING RAILSDOCCETTE
HAND SHOWERS

SHUT-OFF

BORDO VASCA
DECK BATH MIXERFLESSIBILI DOCCIA
SHOWER FLEXIBLES

COLONNE DOCCIA - SHOWER COLUMNS



Set doccia composto da: miscelatore termostatico esterno con deviatore, soffione in acciaio inox con angoli arrotondati 357UFD20X, colonna doccia con fissaggio superiore regolabile in altezza 329X, doccetta in abs con 4 funzioni 318CP, flessibile 150 cm.

Shower set including: exposed thermostatic mixer with diverter, stainless steel 20x20 cm shower head with rounded corners 357UFD20X, shower column with height-adjustable upper fixing 329X, 4-function abs hand shower 318CP, 150 cm flexible hose.

EQ32X8CPUFD20
soffione 20x20 cm.
shower head 20x20 cm.

EQ32X8CPUFD25
soffione 25x25 cm.
shower head 25x25 cm.

EQ32X8CPUFD30
soffione 30x30 cm.
shower head 30x30 cm.

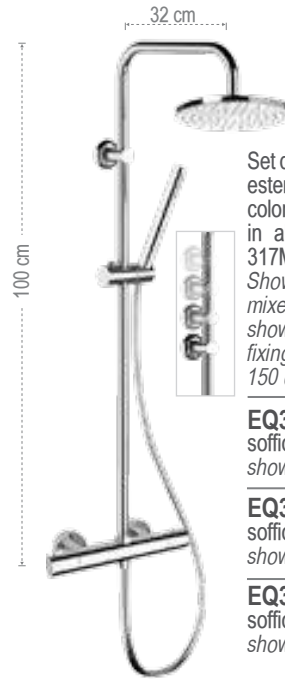

Set doccia composto da: miscelatore termostatico esterno con deviatore, soffione in abs 356MD20X, colonna doccia con fissaggio superiore regolabile in altezza 329X, doccetta in abs, 1 funzione 317MD, flessibile 150 cm.

Shower set including: exposed thermostatic mixer with diverter, abs shower head 356MD20X, shower column with height-adjustable upper fixing 329X, 1-function abs hand shower 317MD, 150 cm flexible hose.

EQ32X7MDMD20
soffione Ø20 cm.
shower head Ø20 cm.

EQ32X7MDMD25
soffione Ø25 cm.
shower head Ø25 cm.

EQ32X7MDMD30
soffione Ø30 cm.
shower head Ø30 cm.

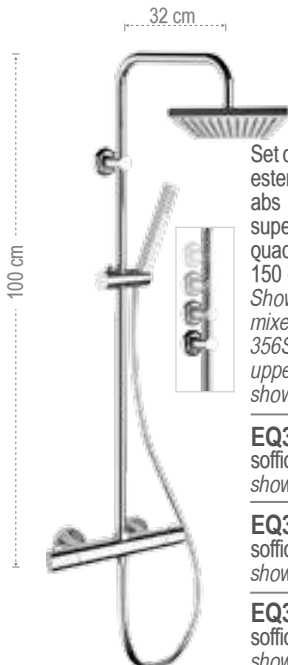

Set doccia composto da: miscelatore termostatico esterno con deviatore, soffione 20x20 cm in abs 356SD20X, colonna doccia con fissaggio superiore regolabile in altezza 329X, doccetta quadrata in ABS, 1 funzione 317SD, flessibile 150 cm.

Shower set including: exposed thermostatic mixer with diverter, abs 20x20 cm shower head 356SD20X, shower column with height-adjustable upper fixing 329X, 1-function abs square hand shower 317SD, 150 cm flexible hose.

EQ32X7SDSD20
soffione 20x20 cm.
shower head 20x20 cm.

EQ32X7SDSD25
soffione 25x25 cm.
shower head 25x25 cm.

EQ32X7SDSD30
soffione 30x30 cm.
shower head 30x30 cm.





EQ32X8CPUFD30

BOX INCASSO
BUILT-IN BOXKIT WELLNESS
WELLNESS KITCROMOTERAPIA
COLOR THERAPYSOFFIONI
SHOWER HEADSBOCCHE
SPOUTSPANNELLI DOCCIA
SHOWER PANELSCOLONNE DOCCIA
SHOWER COLUMNSSALISCENDI
SLIDING RAILSDOCCETTE
HAND SHOWERS

SHUT-OFF

BORDO VASCA
DECK BATH MIXERFLESSIBILI DOCCIA
SHOWER FLEXIBLES

COLONNE DOCCIA TELESCOPICHE TERMOSTATICHE THERMOSTATIC TELESCOPIC SHOWER COLUMN

Set doccia composto da: miscelatore termostatico esterno con deviatore, soffione in acciaio inox 357UFM20X, colonna doccia in ottone telescopica, altezza asta regolabile 329A, doccetta in abs a 4 funzioni 319MO, flessibile 150cm.
Shower set including: exposed thermostatic mixer with diverter, stainless steel shower head 357UFM20X, telescopic brass shower column, with height-adjustable rod 329A, 4-function abs hand shower 319MO, 150 cm flexible hose.

EQ32AUFM20
soffione Ø 20 cm.
shower head Ø 20 cm.

EQ32AUFM25
soffione Ø 25 cm.
shower head Ø 25 cm.

EQ32AUFM30
soffione Ø 30 cm.
shower head Ø 30 cm.

EQ32AEC20
Set doccia composto da: miscelatore termostatico esterno con deviatore, soffione in abs Ø 20cm 354EC20X, colonna doccia in ottone telescopica, altezza asta regolabile 329A, doccetta in abs a 4 funzioni 319MO, flessibile 150 cm.
Shower set including: exposed thermostatic mixer with diverter, abs Ø 20 cm shower head 354EC20X, telescopic brass shower column, with height-adjustable rod 329A, 4-function abs hand shower 319MO, 150 cm flexible hose.

Set doccia composto da: miscelatore termostatico esterno con deviatore, soffione in acciaio inox 357UFM20X, colonna doccia in ottone telescopica, altezza asta regolabile 329A, doccetta in abs con 4 funzioni 318MP, flessibile 150 cm.
Shower set including: exposed thermostatic mixer with diverter, stainless steel shower head 357UFM20X, telescopic brass shower column, with height-adjustable rod 329A, 4-function abs hand shower 318MP, 150 cm flexible hose.

EQ32A8MPUFM20
soffione Ø 20 cm.
shower head Ø 20 cm.

EQ32A8MPUFM25
soffione Ø 25 cm.
shower head Ø 25 cm.

EQ32A8MPUFM30
soffione Ø 30 cm.
shower head Ø 30 cm.

Set doccia composto da: miscelatore termostatico esterno con deviatore, soffione in abs 356MD20X, colonna doccia in ottone telescopica, altezza asta regolabile 329A, doccetta in abs con 4 funzioni 318MP, flessibile 150 cm.
Shower set including: exposed thermostatic mixer with diverter, abs shower head 356MD20X, telescopic brass shower column, with height-adjustable rod 329A, 4-function abs hand shower 318MP, 150 cm flexible hose.

EQ32A8MPMD20
soffione Ø 20 cm.
shower head Ø 20 cm.

EQ32A8MPMD25
soffione Ø 25 cm.
shower head Ø 25 cm.

EQ32A8MPMD30
soffione Ø 30 cm.
shower head Ø 30 cm.

EQ32A8CPAD20
 Set doccia composto da: miscelatore termostatico esterno con deviatore, soffione in abs 20x20cm con angoli arrotondati 356AD20X, colonna doccia in ottone telescopica, altezza asta regolabile 329A, doccetta in abs con 4 funzioni 318CP, flessibile 150 cm.
Shower set including: exposed thermostatic mixer with diverter, abs 20x20 cm shower head with rounded corners 356AD20X, telescopic brass shower column, with height-adjustable rod 329A, 4-function abs hand shower 318CP, 150 cm flexible hose.

EQ32A8CPUD20
 soffione 20X20 cm.
 shower head 20X20 cm.

EQ32A8CPUD25
 soffione 25X25 cm.
 shower head 25X25 cm.

EQ32A8CPUD30
 soffione 30X30 cm.
 shower head 30X30 cm.

EQ32A7SDSD20
 soffione 20x20 cm.
 shower head 20x20 cm.

EQ32A7SDSD25
 soffione 25x25 cm.
 shower head 25x25 cm.

EQ32A7SDSD30
 soffione 30x30 cm.
 shower head 30x30 cm.

EQ32A7SDUFD20
 soffione 20X20 cm.
 shower head 20X20 cm.

EQ32A7SDUFD25
 soffione 25X25 cm.
 shower head 25X25 cm.

EQ32A7SDUFD30
 soffione 30X30 cm.
 shower head 30X30 cm.

BOX INCASSO
BUILT-IN BOX

KIT WELLNESS
WELLNESS KIT

CRONOTERAPIA
COLOR THERAPY

SOFFIONI
SHOWER HEADS

BOCCHE
SPOUTS

PANNELLI DOCCIA
SHOWER PANELS

COLONNE DOCCIA
SHOWER COLUMNS

SALISCENDI
SLIDING RAILS

DOCCETTE
HAND SHOWERS

SHUT-OFF

BORDO VASCA
DECK BATH MIXER

FLESSIBILI DOCCIA
SHOWER FLEXIBLES

COLONNE DOCCIA 3 VIE TELESCOPICHE TERMOSTATICHE 3 WAYS THERMOSTATIC TELESCOPIC SHOWER COLUMN



Set doccia composto da: miscelatore termostatico esterno con deviatore vasca/doccia, soffione in abs 356MD20X, colonna doccia in ottone telescopica, altezza asta regolabile 329A, doccetta in abs, 1 funzione 317MD, flessibile 150 cm.

Shower set including: exposed thermostatic mixer with bath/shower diverter, abs shower head 356MD20X, telescopic brass shower column, with height-adjustable rod 329A, 1-function abs hand shower 317MD, 150 cm flexible hose.

EQ34A7MDMD20

Soffione Ø 20 cm.
Shower head Ø 20 cm.

EQ34A7MDMD25

Soffione Ø 25 cm.
Shower head Ø 25 cm.

EQ34A7MDMD30

Soffione Ø 30 cm.
Shower head Ø 30 cm.



Set doccia composto da: miscelatore termostatico esterno con deviatore vasca/doccia, soffione in abs 356SD20X, colonna doccia in ottone telescopica, altezza asta regolabile 329A, doccetta quadrata in ABS, 1 funzione 317SD, flessibile 150 cm.

Shower set including: exposed thermostatic mixer with bath/shower diverter, abs shower head 356SD20X, telescopic brass shower column, with height-adjustable rod 329A, 1-function abs square hand shower 317SD, 150 cm flexible hose.

EQ34A7SDSD20

Soffione 20x20 cm.
Shower head 20x20 cm.

EQ34A7SDSD25

Soffione 25x25 cm.
Shower head 25x25 cm.

EQ34A7SDSD30

Soffione 30x30 cm.
Shower head 30x30 cm.



Set doccia composto da: miscelatore termostatico esterno con deviatore vasca/doccia, soffione in acciaio inox 357UFM20X, colonna doccia in ottone telescopica, altezza asta regolabile 329A, doccetta in abs con 4 funzioni 318MP, flessibile 150 cm.

Shower set including: exposed thermostatic mixer with bath/shower diverter, stainless steel shower head 357UFM20X, telescopic brass shower column, with height-adjustable rod 329A, 4-function abs hand shower 318MP, 150 cm flexible hose.

EQ34A8MPUFM20

Soffione Ø 20 cm.
Shower head Ø 20 cm.

EQ34A8MPUFM25

Soffione Ø 25 cm.
Shower head Ø 25 cm.

EQ34A8MPUFM30

Soffione Ø 30 cm.
Shower head Ø 30 cm.



Set doccia composto da: miscelatore termostatico esterno con deviatore vasca/doccia, soffione quadrato ultrapiatto in acciaio inox lucidato a specchio 357UFS20X, colonna doccia in ottone telescopica con altezza asta regolabile e deviatore 329°, doccetta in abs cromato, 4 funzioni 318CP, flessibile 150 cm.

Shower set including: exposed thermostatic mixer with bath/shower diverter, ultra-flat square shower head in mirror polished stainless steel 357UFS20X, telescopic brass shower column with height-adjustable rod and diverter 329A; 4-function c.p. abs handshower 318CP, 150 cm flexible hose.

EQ34A8CPUFS20

Soffione 20x20 cm.
Shower head 20x20 cm.

EQ34A8CPUFS25

Soffione 25x25 cm.
Shower head 25x25 cm.

EQ34A8CPUFS30

Soffione 30x30 cm.
Shower head 30x30 cm.





EQ34A8MPUFM20

BOX INCASSO
BUILT-IN BOXKIT WELLNESS
WELLNESS KITCROMOTERAPIA
COLOR THERAPYSOFFIONI
SHOWER HEADSBOCCHE
SPOUTSPANNELLI DOCCIA
SHOWER PANELSCOLONNE DOCCIA
SHOWER COLUMNSSALISCENDI
SLIDING RAILSDOCCETTE
HAND SHOWERS

SHUT-OFF

BORDO VASCA
DECK BATH MIXERFLESSIBILI DOCCIA
SHOWER FLEXIBLES

COLONNE DOCCIA TELESCOPICHE CON PRESA ACQUA ESTERNA TELESCOPIC SHOWER COLUMN WITH EXTERNAL WATER PUNCH

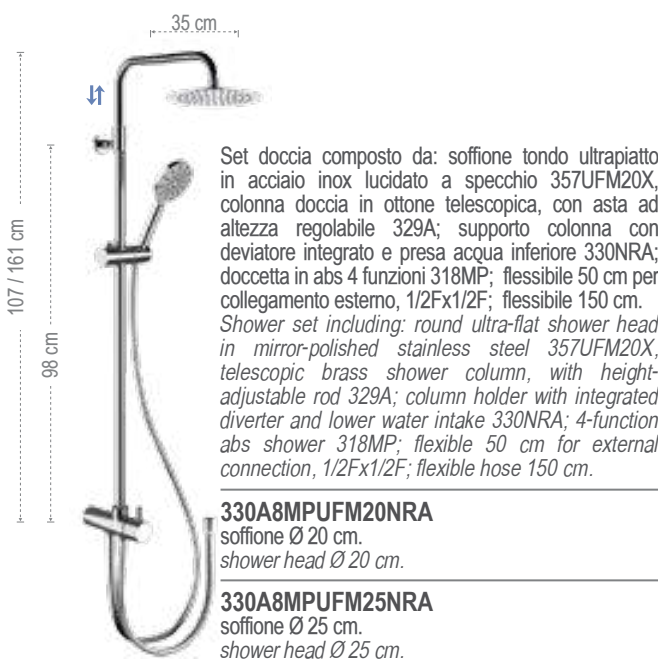

Set doccia composto da: soffione tondo ultrapiatto in acciaio inox lucidato a specchio 357UFM20X, colonna doccia in ottone telescopica, con asta ad altezza regolabile 329A; supporto colonna con deviatore integrato e presa acqua inferiore 330NRA; doccetta in abs 4 funzioni 318MP; flessibile 50 cm per collegamento esterno, 1/2Fx1/2F; flessibile 150 cm.

Shower set including: round ultra-flat shower head in mirror-polished stainless steel 357UFM20X, telescopic brass shower column, with height-adjustable rod 329A; column holder with integrated diverter and lower water intake 330NRA; 4-function abs shower 318MP; flexible 50 cm for external connection, 1/2Fx1/2F; flexible hose 150 cm.

330A8MPUFM20NRA
soffione Ø 20 cm.
shower head Ø 20 cm.

330A8MPUFM25NRA
soffione Ø 25 cm.
shower head Ø 25 cm.

330A8MPUFM30NRA
soffione Ø 30 cm.
shower head Ø 30 cm.



Set doccia composto da: soffione in acciaio inox con angoli arrotondati 357UFD20X, colonna doccia in ottone telescopica, altezza asta regolabile 329A, supporto colonna con deviatore integrato e presa acqua inferiore, doccetta in abs con 4 funzioni 318CP, flessibile 50 cm per collegamento esterno, 1/2Fx1/2F, flessibile 150 cm.

Shower set including: stainless steel shower head with rounded corners 357UFD20X, telescopic brass shower column, with height-adjustable rod 329A, column holder with integrated diverter and lower water connection, 4-function abs hand shower 318CP, 50 cm flexible hose for external connection, 1/2Fx1/2F, 150 cm flexible hose.

330A8CPUFD20NRA
soffione 20x20 cm.
shower head 20x20 cm.

330A8CPUFD25NRA
soffione 25x25 cm.
shower head 25x25 cm.

330A8CPUFD30NRA
soffione 30x30 cm.
shower head 30x30 cm.



330A8MPEC20NRA

Set doccia composto da: soffione Ø 20 cm in abs cromato 354EC20X, colonna doccia in ottone telescopica, con asta ad altezza regolabile 329A; supporto colonna con deviatore integrato e presa acqua inferiore 330NRA; doccetta in abs 4 funzioni 318MP; flessibile 50 cm per collegamento esterno, 1/2Fx1/2F; flessibile 150 cm.

Shower set including: Ø 20 cm c.p. abs shower head 354EC20X, telescopic brass shower column, with height-adjustable rod 329A; column holder with integrated diverter and lower water intake 330NRA; 4-function abs shower 318MP; flexible 50 cm for external connection, 1/2Fx1/2F; flexible hose 150 cm.



330A8CPAD20NRA

Set doccia composto da: soffione in abs 20x20cm con angoli arrotondati 356AD20X, colonna doccia in ottone telescopica, altezza asta regolabile 329A, supporto colonna con deviatore integrato e presa acqua inferiore, doccetta in abs con 4 funzioni 318CP, flessibile 50 cm per collegamento esterno, 1/2Fx1/2F, flessibile 150 cm.

Shower set including: abs 20x20 cm shower head with rounded corners 356AD20X, telescopic brass shower column, with height-adjustable rod 329A, column holder with integrated diverter and lower water connection, 4-function abs hand shower 318CP, 50 cm flexible hose for external connection, 1/2Fx1/2F, 150 cm flexible hose.



COLONNE DOCCIA CON PRESA ACQUA ESTERNA SHOWER COLUMN WITH EXTERNAL WATER PUNCH

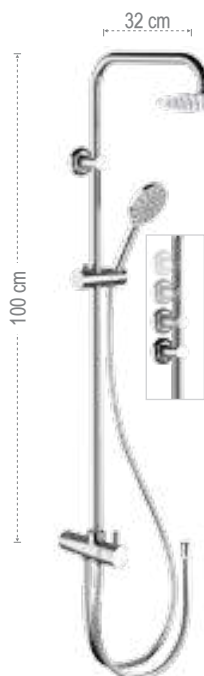

Set doccia composto da: soffione tondo ultrapiatto in acciaio inox lucidato a specchio 357UFM20X, colonna doccia con fissaggio superiore regolabile 329X; supporto colonna con deviatore integrato e presa acqua inferiore 330NRA; doccetta in abs 4 funzioni 318MP; flessibile 50 cm per collegamento esterno, 1/2Fx1/2F; flessibile 150 cm.

Shower set including: round ultra-flat shower head in mirror-polished stainless steel 357UFM20X, shower column with adjustable upper fixing 329X; column holder with diverter and lower water intake 330NRA; 4-function abs shower 318MP; flexible hose 50 cm for external connection, 1 / 2Fx1/2F; flexible hose 150 cm.

330X8MPUFM20NRA
soffione Ø 20 cm.
shower head Ø 20 cm.

330X8MPUFM25NRA
soffione Ø 25 cm.
shower head Ø 25 cm.

330X8MPUFM30NRA
soffione Ø 30 cm.
shower head Ø 30 cm.



Set doccia composto da: soffione in acciaio inox con angoli arrotondati 357UFD20X, colonna doccia con fissaggio superiore regolabile in altezza 329X, supporto colonna con deviatore integrato e presa acqua inferiore, doccetta in abs con 4 funzioni 318CP; flessibile 50 cm per collegamento esterno, 1/2Fx1/2F; flessibile 150 cm.

Shower set including: stainless steel shower head with rounded corners 357UFD20X, shower column with height-adjustable upper fixing 329X, column holder with integrated diverter and lower water connection, 4-function abs hand shower 318CP, 50 cm flexible hose for external connection, 1/2Fx1/2F, 150 cm flexible hose.

330X8CPUFD20NRA
soffione 20x20 cm.
shower head 20x20 cm.

330X8CPUFD25NRA
soffione 25x25 cm.
shower head 25x25 cm.

330X8CPUFD30NRA
soffione 30x30 cm.
shower head 30x30 cm.

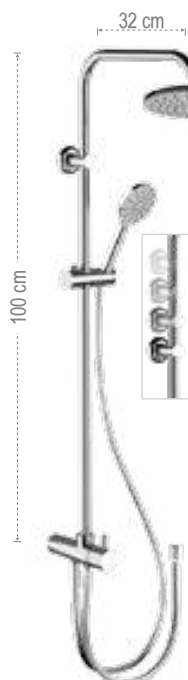

330X8MPEC20NRA

Set doccia composto da: soffione Ø 20 cm in abs cromato 354EC20X, colonna doccia con fissaggio superiore regolabile 329X; supporto colonna con deviatore integrato e presa acqua inferiore 330NRA; doccetta in abs 4 funzioni 318MP; flessibile 50 cm per collegamento esterno, 1/2Fx1/2F; flessibile 150 cm.

Shower set including: Ø 20 cm c.p. abs shower head 354EC20X, shower column with adjustable upper fixing 329X; column holder with diverter and lower water intake 330NRA; 4-function abs shower 318MP; flexible hose 50 cm for external connection, 1 / 2Fx1/2F; flexible hose 150 cm.



330X8CPAD20NRA

Set doccia composto da: soffione in abs 20x20cm con angoli arrotondati 356AD20X, colonna doccia con fissaggio superiore regolabile in altezza 329X, supporto colonna con deviatore integrato e presa acqua inferiore, doccetta in abs con 4 funzioni 318CP; flessibile 50 cm per collegamento esterno, 1/2Fx1/2F; flessibile 150 cm.

Shower set including: abs 20x20 cm shower head with rounded corners 356AD20X, shower column with height-adjustable upper fixing 329X, column holder with integrated diverter and lower water connection, 4-function abs hand shower 318CP, 50 cm flexible hose for external connection, 1/2Fx1/2F, 150 cm flexible hose.

BOX INCASSO
BUILT-IN BOXKIT WELLNESS
WELLNESS KITCROMOTERAPIA
COLOR THERAPYSOFFIONI
SHOWER HEADSBOCCHE
SPOUTSPANNELLI DOCCIA
SHOWER PANELSCOLONNE DOCCIA
SHOWER COLUMNSSALISCENDI
SLIDING RAILSDOCCETTE
HAND SHOWERS

SHUT-OFF

BORDO VASCA
DECK BATH MIXERFLESSIBILI DOCCIA
SHOWER FLEXIBLES

COLONNE DOCCIA CON MISCELATORE SHOWER COLUMN WITH SHOWER MIXER

CON OPZIONI DI FINITURA



WITH FINISHING OPTIONS

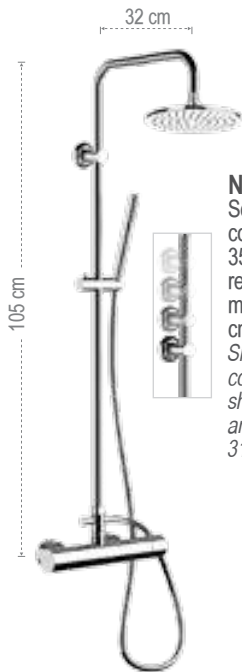

N37RX7MMM20

Set doccia composto da: miscelatore esterno con attacco superiore, soffione in ottone Ø 20 cm 359MM20X, colonna doccia con fissaggio superiore regolabile in altezza, con deviatore 330X, doccetta minimale in ottone, 1 funzione 317MM, flessibile 150 cm.

Shower set including: exposed mixer with upper connection, brass shower head Ø 20 cm 359MM20X, shower column with height-adjustable upper fixing and diverter 330X, 1-function brass hand shower 317MM, 150 cm flexible hose.

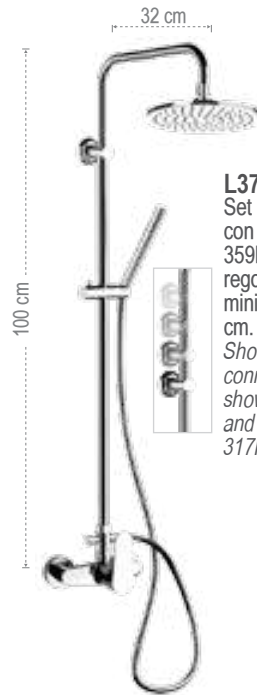

L37X7MMM20

Set doccia composto da: miscelatore esterno con attacco superiore, soffione in ottone Ø 20 cm 359MM20X, colonna doccia con fissaggio superiore regolabile in altezza, con deviatore 330X, doccetta minimale in ottone, 1 funzione 317MM, flessibile 150 cm.

Shower set including: exposed mixer with upper connection, brass shower head Ø 20 cm 359MM20X, shower column with height-adjustable upper fixing and diverter 330X, 1-function brass hand shower 317MM, 150 cm flexible hose.

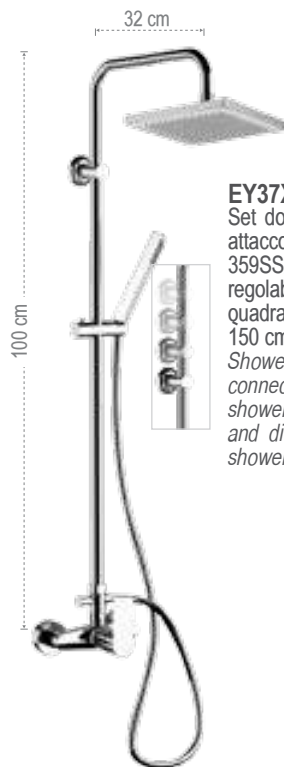

EY37X7SS9SS

Set doccia composto da: miscelatore esterno con attacco superiore, soffione in ottone 20x20cm 359SSX, colonna doccia con fissaggio superiore regolabile in altezza, con deviatore 330X, doccetta quadrata in ottone a 1 funzione 317SS, flessibile 150 cm.

Shower set including: exposed mixer with upper connection, brass shower head 20x20cm 359SSX, shower column with height-adjustable upper fixing and diverter 330X, 1-function brass square hand shower 317SS, 150 cm flexible hose.



FIN 1

NO

BO

NP

NPO

FIN 2

CFP

BG

DO

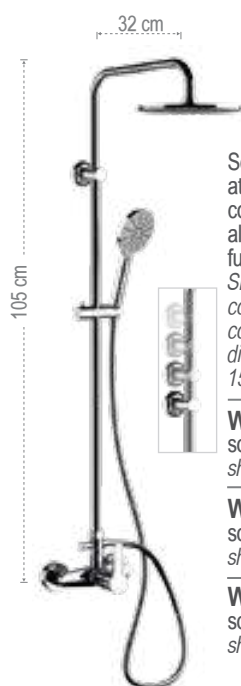

Set doccia composto da: miscelatore esterno con attacco superiore, soffione in abs 356MD20X, colonna doccia con fissaggio superiore regolabile in altezza, con deviatore 330X, doccetta in abs con 4 funzioni 318MP, flessibile 150 cm.

Shower set including: exposed mixer with upper connection, abs shower head 356MD20X, shower column with height-adjustable upper fixing and diverter 330X, 4-function abs hand shower 318MP, 150 cm flexible hose.

W37X8MPMD20

soffione Ø 20 cm.
shower head Ø 20 cm.

W37X8MPMD25

soffione Ø 25 cm.
shower head Ø 25 cm.

W37X8MPMD30

soffione Ø 30 cm.
shower head Ø 30 cm.



Set doccia composto da: miscelatore esterno con attacco superiore, soffione in acciaio inox 357UFM20X, colonna doccia con fissaggio superiore regolabile in altezza, con deviatore 330X, doccetta in abs con 4 funzioni 318MP, flessibile 150 cm.

Shower set including: exposed mixer with upper connection, stainless steel shower head 357UFM20X, shower column with height-adjustable upper fixing and diverter 330X, 4-function abs hand shower 318MP, 150 cm flexible hose.

W37X8MPUFM20

soffione Ø 20 cm.
shower head Ø 20 cm.

W37X8MPUFM25

soffione Ø 25 cm.
shower head Ø 25 cm.

W37X8MPUFM30

soffione Ø 30 cm.
shower head Ø 30 cm.

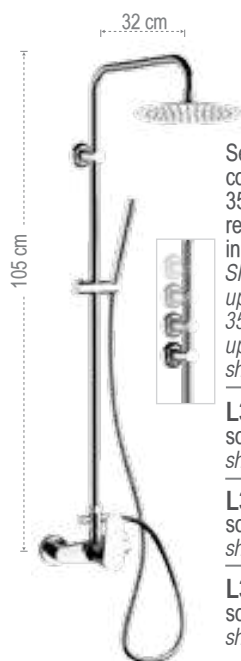

Set doccia composto da: miscelatore esterno con attacco superiore, soffione in acciaio inox 357UFM20X, colonna doccia con fissaggio superiore regolabile in altezza, con deviatore 330X, doccetta in abs, 1 funzione 317MD, flessibile 150 cm.

Shower set including: exposed mixer with upper connection, stainless steel shower head 357UFM20X, shower column with height-adjustable upper fixing and diverter 330X, 1-function abs hand shower 317MD, 150 cm flexible hose.

L37X7MDUFM20

soffione Ø 20 cm.
shower head Ø 20 cm.

L37X7MDUFM25

soffione Ø 25 cm.
shower head Ø 25 cm.

L37X7MDUFM30

soffione Ø 30 cm.
shower head Ø 30 cm.

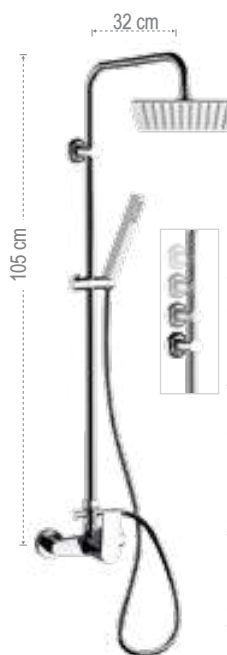

Set doccia composto da: miscelatore esterno con attacco superiore, soffione in acciaio inox con angoli arrotondati 357UFD20X, colonna doccia con fissaggio superiore regolabile in altezza, con deviatore 330X, doccetta quadrata in ABS, 1 funzione 317SD, flessibile 150 cm.

Shower set including: exposed mixer with upper connection, stainless steel shower head with rounded corners 357UFD20X, shower column with height-adjustable upper fixing and diverter 330X, 1-function abs square hand shower 317SD, 150 cm flexible hose.

D37X7SDUFD20

soffione 20x20 cm.
shower head 20x20 cm.

D37X7SDUFD25

soffione 25x25 cm.
shower head 25x25 cm.

D37X7SDUFD30

soffione 30x30 cm.
shower head 30x30 cm.

BOX INCASSO
BUILT-IN BOXKIT WELLNESS
WELLNESS KITCROMOTERAPIA
COLOR THERAPYSOFFIONI
SHOWER HEADSBOCCHE
SPOUTSPANNELLI DOCCIA
SHOWER PANELSCOLONNE DOCCIA
SHOWER COLUMNSSALISCENDI
SLIDING RAILSDOCCETTE
HAND SHOWERS

SHUT-OFF

BORDO VASCA
DECK BATH MIXERFLESSIBILI DOCCIA
SHOWER FLEXIBLES

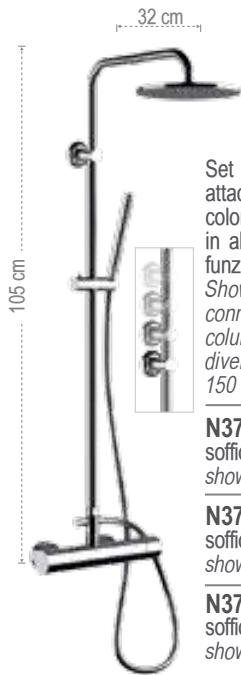

Set doccia composto da: miscelatore esterno con attacco superiore, soffione in abs 356MD20X, colonna doccia con fissaggio superiore regolabile in altezza, con deviatore 330X, doccetta in abs, 1 funzione 317MD, flessibile 150 cm.

Shower set including: exposed mixer with upper connection, abs shower head 356MD20X, shower column with height-adjustable upper fixing and diverter 330X, 1-function abs hand shower 317MD, 150 cm flexible hose.

N37RXMD20

soffione Ø 20 cm.
shower head Ø 20 cm.

N37RXMD25

soffione Ø 25 cm.
shower head Ø 25 cm.

N37RXMD30

soffione Ø 30 cm.
shower head Ø 30 cm.

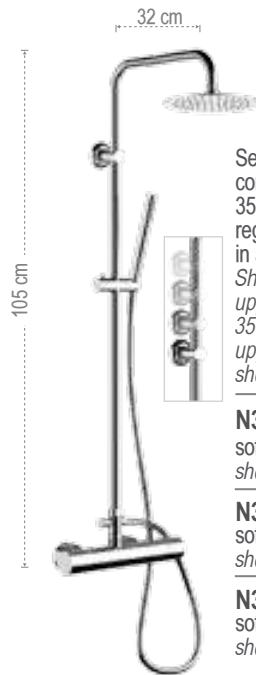

Set doccia composto da: miscelatore esterno con attacco superiore, soffione in acciaio inox 357UFM20X, colonna doccia con fissaggio superiore regolabile in altezza, con deviatore 330X, doccetta in abs, 1 funzione 317MD, flessibile 150 cm.

Shower set including: exposed mixer with upper connection, stainless steel shower head 357UFM20X, shower column with height-adjustable upper fixing and diverter 330X, 1-function abs hand shower 317MD, 150 cm flexible hose.

N37RXUFM20

soffione Ø 20 cm.
shower head Ø 20 cm.

N37RXUFM25

soffione Ø 25 cm.
shower head Ø 25 cm.

N37RXUFM30

soffione Ø 30 cm.
shower head Ø 30 cm.

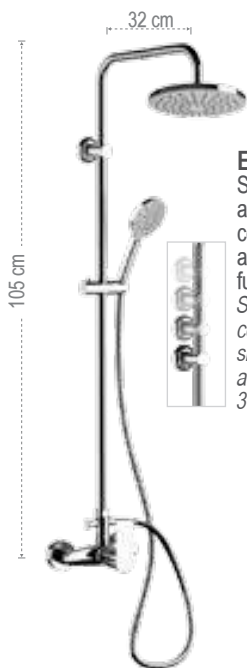

EY37XEC20

Set doccia composto da: miscelatore esterno con attacco superiore, soffione in abs Ø 20cm 354EC20X, colonna doccia con fissaggio superiore regolabile in altezza, con deviatore 330X, doccetta in abs con 4 funzioni 318MP, flessibile 150 cm.

Shower set including: exposed mixer with upper connection, abs Ø 20 cm shower head 354EC20X, shower column with height-adjustable upper fixing and diverter 330X, 4-function abs hand shower 318MP, 150 cm flexible hose.

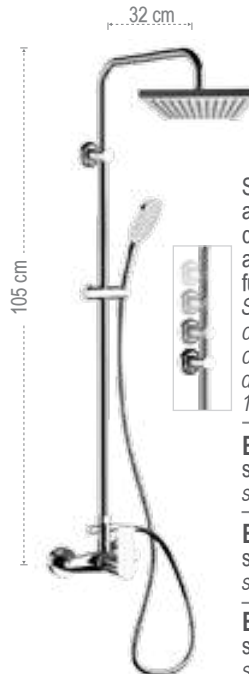

Set doccia composto da: miscelatore esterno con attacco superiore, soffione in abs 356SD20X, colonna doccia con fissaggio superiore regolabile in altezza, con deviatore 330X, doccetta in abs con 4 funzioni 318CP, flessibile 150 cm.

Shower set including: exposed mixer with upper connection, abs shower head 356SD20X, shower column with height-adjustable upper fixing and diverter 330X, 4-function abs hand shower 318CP, 150 cm flexible hose.

EY37XSD20

soffione 20x20 cm.
shower head 20x20 cm.

EY37XSD25

soffione 25x25 cm.
shower head 25x25 cm.

EY37XSD30

soffione 30x30 cm.
shower head 30x30 cm.





N37RXUFM20

FLESSIBILI DOCCIA
SHOWER FLEXIBLESBORDO VASCA
DECK BATH MIXER

SHUT-OFF

DOCCETTE
HAND SHOWERSSALISCENDI
SLIDING RAILS**COLONNE DOCCIA**
SHOWER COLUMNSPANNELLI DOCCIA
SHOWER PANELSBOCCHE
SPOUTSSOFFIONI
SHOWER HEADSCROMOTERAPIA
COLOR THERAPYKIT WELLNESS
WELLNESS KITBOX INCASSO
BUILT-IN BOX

COLONNE DOCCIA TELESCOPICHE CON MISCELATORE TELESCOPIC SHOWER COLUMN WITH SHOWER MIXER

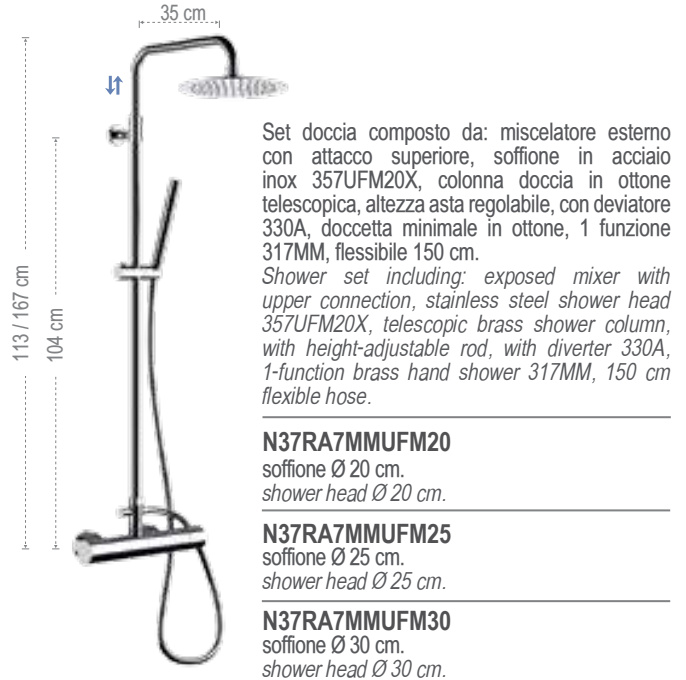
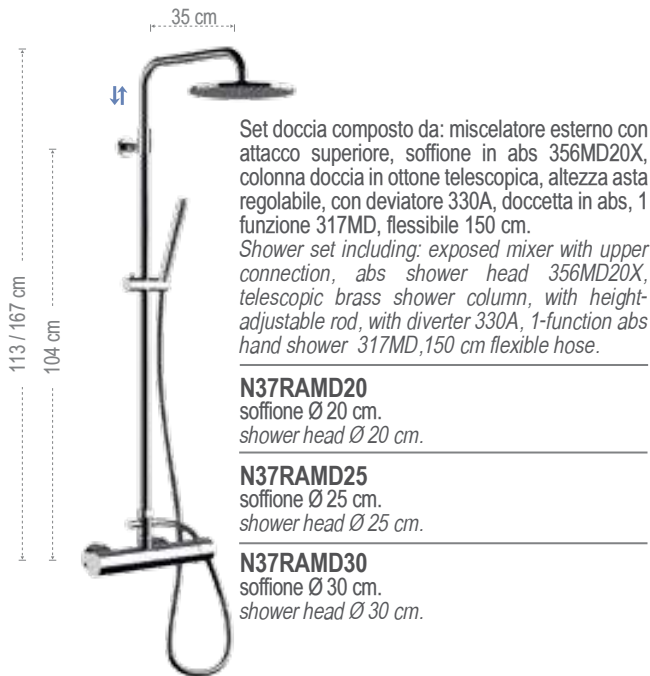

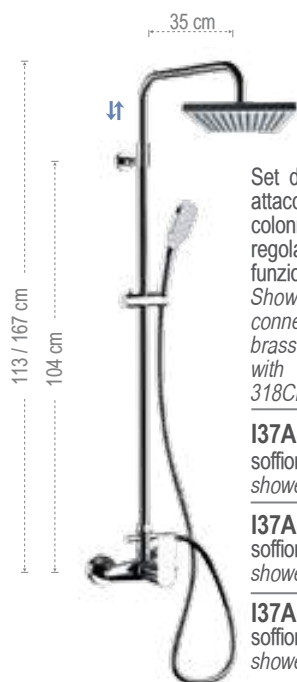

Set doccia composto da: miscelatore esterno con attacco superiore, soffione in abs 356SD20X, colonna doccia in ottone telescopica, altezza asta regolabile, con deviatore 330A, doccetta in abs con 4 funzioni 318CP, flessibile 150 cm.

Shower set including: exposed mixer with upper connection, abs shower head 356SD20X, telescopic brass shower column, with height-adjustable rod, with diverter 330A, 4-function abs hand shower 318CP, 150 cm flexible hose.

I37A8CPSD20

soffione 20x20 cm.
shower head 20x20 cm.

I37A8CPSD25

soffione 25x25 cm.
shower head 25x25 cm.

I37A8CPSD30

soffione 30x30 cm.
shower head 30x30 cm.

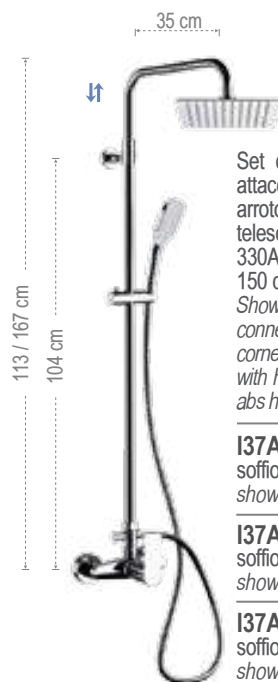

Set doccia composto da: miscelatore esterno con attacco superiore, soffione in acciaio inox con angoli arrotondati 357UFD20X, colonna doccia in ottone telescopica, altezza asta regolabile, con deviatore 330A, doccetta in abs con 4 funzioni 318CP, flessibile 150 cm.

Shower set including: exposed mixer with upper connection, stainless steel shower head with rounded corners 357UFD20X, telescopic brass shower column, with height-adjustable rod, with diverter 330A, 4-function abs hand shower 318CP, 150 cm flexible hose.

I37A8CPUFD20

soffione 20x20 cm.
shower head 20x20 cm.

I37A8CPUFD25

soffione 25x25 cm.
shower head 25x25 cm.

I37A8CPUFD30

soffione 30x30 cm.
shower head 30x30 cm.

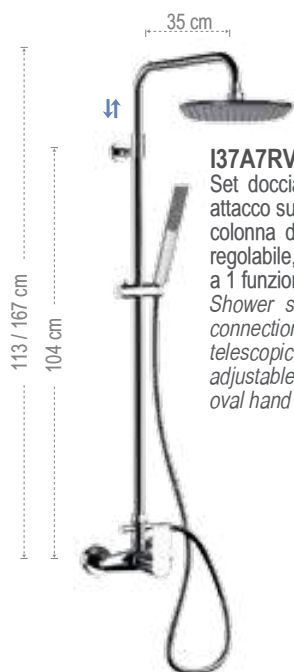

I37A7RV54QI

Set doccia composto da: miscelatore esterno con attacco superiore, soffione 20x20 cm in abs 354QIX, colonna doccia in ottone telescopica, altezza asta regolabile, con deviatore 330A, doccetta ovale in abs a 1 funzione 317RV, flessibile 150 cm.

Shower set including: exposed mixer with upper connection, abs 20x20 cm shower head 354QIX, telescopic brass shower column, with height-adjustable rod, with diverter 330A, 1-function abs oval hand shower 317RV, 150 cm flexible hose.

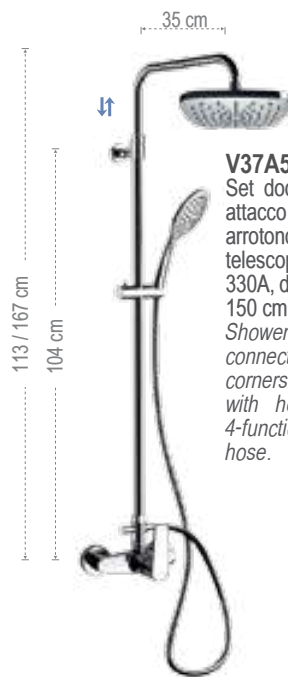

V37A5P3AD20

Set doccia composto da: miscelatore esterno con attacco superiore, soffione in abs 20x20cm con angoli arrotondati 356AD20X, colonna doccia in ottone telescopica, altezza asta regolabile, con deviatore 330A, doccetta in abs con 4 funzioni 315P3, flessibile 150 cm.

Shower set including: exposed mixer with upper connection, abs 20x20 cm shower head with rounded corners 356AD20X, telescopic brass shower column, with height-adjustable rod, with diverter 330A, 4-function abs hand shower 315P3, 150 cm flexible hose.

BOX INCASSO
BUILT-IN BOXKIT WELLNESS
WELLNESS KITCROMOTERAPIA
COLOR THERAPYSOFFIONI
SHOWER HEADSBOCCHE
SPOUTSPANNELLI DOCCIA
SHOWER PANELSCOLONNE DOCCIA
SHOWER COLUMNSSALISCENDI
SLIDING RAILSDOCCETTE
HAND SHOWERS

SHUT-OFF

BORDO VASCA
DECK BATH MIXERFLESSIBILI DOCCIA
SHOWER FLEXIBLES

COLONNE DOCCIA QUADRATE SQUARED SHOWER COLUMN

CON OPZIONI DI FINITURA



WITH FINISHING OPTIONS



Q377SS

Set doccia composto da: miscelatore esterno con attacco superiore, soffione in ottone 20x20cm 359SSX, colonna doccia quadrata in ottone con deviatore 330S, doccetta quadrata in ottone a 1 funzione 317SS, flessibile 150 cm.

Shower set including: exposed mixer with upper connection, brass shower head 20x20cm 359SSX, square brass shower column with diverter 330S, 1-function brass square hand shower 317SS, 150 cm flexible hose.



Q37XL7SS

Set doccia composto da: miscelatore esterno con attacco superiore, soffione in ottone 35x35cm 359SSXLX, colonna doccia quadrata in ottone con deviatore 330S, doccetta quadrata in ottone a 1 funzione 317SS, flessibile 150 cm.

Shower set including: exposed mixer with upper connection, brass shower head 35x35cm 359SSXLX, square brass shower column with diverter 330S, 1-function brass square hand shower 317SS, 150 cm flexible hose.



FIN 1

NO

BO

NP

NPO

FIN 2

CFP

BG

DO

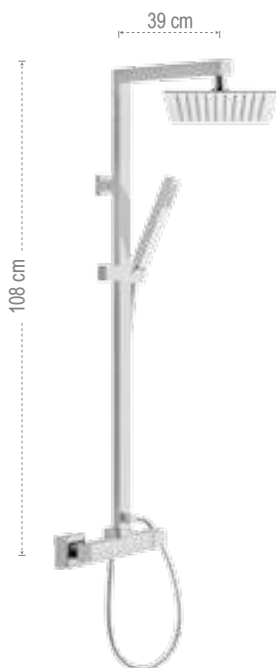

Set doccia composto da: miscelatore esterno con attacco superiore, soffione in acciaio inox 357UFS20X, colonna doccia quadrata in ottone con deviatore 330S, doccetta quadrata in ABS, 1 funzione 317SD, flessibile 150 cm.

Shower set including: exposed mixer with upper connection, stainless steel shower head 357UFS20X, square brass shower column with diverter 330S, 1-function abs square hand shower 317SD, 150 cm flexible hose.

Q377SDUFS20

soffione 20x20 cm.
shower head 20x20 cm.

Q377SDUFS25

soffione 25x25 cm.
shower head 25x25 cm.

Q377SDUFS30

soffione 30x30 cm.
shower head 30x30 cm.



COLONNE DOCCIA TERMOSTATICHE QUADRATE THERMOSTATIC SQUARED SHOWER COLUMN

CON OPZIONI DI FINITURA  WITH FINISHING OPTIONS

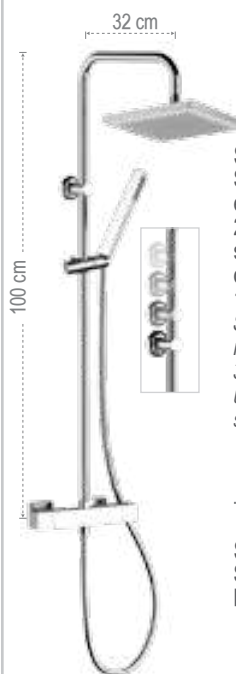

ST32LX7SS9SS

Set doccia composto da: miscelatore termostatico esterno quadrato con deviatore, soffione in ottone 20x20cm 359SSX, colonna doccia con fissaggio superiore regolabile in altezza 329X, doccetta quadrata in ottone a 1 funzione 317SS, flessibile 150 cm.

Shower set including: square exposed thermostatic mixer with diverter, brass shower head 20x20cm 359SSX, shower column with height-adjustable upper fixing 329X, 1-function brass square hand shower 317SS, 150 cm flexible hose.

ST32LX7SSSSL

Soffione in ottone 30x30cm
Brass shower head 30x30cm



FIN 1

NO

BO

NP

NPO

FIN 2

CFP

BG

DO



ST32LS7SS9SS

Set doccia composto da: miscelatore termostatico esterno quadrato con deviatore, soffione in ottone 20x20cm 359SSX, colonna doccia quadrata in ottone 329S, doccetta quadrata in ottone a 1 funzione 317SS, flessibile 150 cm.

Shower set including: square exposed thermostatic mixer with diverter, brass shower head 20x20cm 359SSX, square brass shower column 329S, 1-function brass square hand shower 317SS, 150 cm flexible hose.

ST32LS7SSSSL

Soffione in ottone 30x30cm
Brass shower head 30x30cm

BOX INCASSO
BUILT-IN BOXKIT WELLNESS
WELLNESS KITCROMOTERAPIA
COLOR THERAPYSOFFIONI
SHOWER HEADSBOCCHE
SPOUTSPANNELLI DOCCIA
SHOWER PANELSCOLONNE DOCCIA
SHOWER COLUMNSSALISCENDI
SLIDING RAILSDOCCETTE
HAND SHOWERS

SHUT-OFF

BORDO VASCA
DECK BATH MIXERFLESSIBILI DOCCIA
SHOWER FLEXIBLES



Set doccia composto da: miscelatore termostatico esterno quadrato con deviatore, soffione in abs 356SD20X, colonna doccia quadrata in ottone 329S, doccetta quadrata in ABS, 1 funzione 317SD, flessibile 150 cm.
Shower set including: square exposed thermostatic mixer with diverter, abs shower head 356SD20X, square brass shower column 329S, 1-function abs square hand shower 317SD, 150 cm flexible hose.

ST32S7SDSD20

soffione in ABS anticalcare 20x20 cm.
 ABS antilimestone showerhead 20x20 cm.

ST32S7SDSD25

soffione in ABS anticalcare 25x25 cm.
 ABS antilimestone showerhead 25x25 cm.

ST32S7SDSD30

soffione in ABS anticalcare 30x30 cm.
 ABS antilimestone showerhead 30x30 cm.



ST32LS7SQUFS20

Set doccia composto da: miscelatore termostatico esterno quadrato con deviatore, soffione in acciaio inox 20x20cm 357UFS20X, colonna doccia quadrata in ottone 329S, doccetta in abs a 1 funzione 317SQ, flessibile 150 cm.

Shower set including: square exposed thermostatic mixer with diverter, stainless steel 20x20cm shower head 357UFS20X, square brass shower column 329S, 1-function abs hand shower 317SQ, 150 cm flexible hose.



Set doccia composto da: miscelatore termostatico esterno quadrato con deviatore, soffione in abs 356SD20X, colonna doccia con fissaggio superiore regolabile in altezza 329X, doccetta quadrata in ABS, 1 funzione 317SD, flessibile 150 cm.

Shower set including: square exposed thermostatic mixer with diverter, abs shower head 356SD20X, shower column with height-adjustable upper fixing 329X, 1-function abs square hand shower 317SD, 150 cm flexible hose.

ST32X7SDSD20

con soffione in acciaio inox anticalcare 20x20 cm.
 with stainless steel antilimestone showerhead 20x20 cm.

ST32X7SDSD25

con soffione in acciaio inox anticalcare 25x25 cm.
 with stainless steel antilimestone showerhead 25x25 cm.

ST32X7SDSD30

con soffione in acciaio inox anticalcare 30x30 cm.
 with stainless steel antilimestone showerhead 30x30 cm.



Set doccia composto da: miscelatore termostatico esterno quadrato con deviatore, soffione in acciaio inox 20x20cm 357UFS20X, colonna doccia con fissaggio superiore regolabile in altezza 329X, doccetta quadrata in ABS, 1 funzione 317SD, flessibile 150 cm.

Shower set including: square exposed thermostatic mixer with diverter, stainless steel shower head 357UFS20X, shower column with height-adjustable upper fixing 329X, 1-function abs square hand shower 317SD, 150 cm flexible hose.

ST32X7SDUFS20

con soffione in acciaio inox anticalcare 20x20 cm.
 with stainless steel antilimestone showerhead 20x20 cm.

ST32X7SDUFS25

con soffione in acciaio inox anticalcare 25x25 cm.
 with stainless steel antilimestone showerhead 25x25 cm.

ST32X7SDUFS30

con soffione in acciaio inox anticalcare 30x30 cm.
 with stainless steel antilimestone showerhead 30x30 cm.





ST32S7SDSD30

BOX INCASSO
BUILT-IN BOXKIT WELLNESS
WELLNESS KITCROMOTERAPIA
COLOR THERAPYSOFFIONI
SHOWER HEADSBOCCHE
SPOUTSPANNELLI DOCCIA
SHOWER PANELSCOLONNE DOCCIA
SHOWER COLUMNSSALISCENDI
SLIDING RAILSDOCCETTE
HAND SHOWERS

SHUT-OFF

BORDO VASCA
DECK BATH MIXERFLESSIBILI DOCCIA
SHOWER FLEXIBLES

COLONNE DOCCIA CLASSICHE CLASSIC SHOWER COLUMNS



09LIB20

€ 762,30

Gruppo vasca-doccia tradizionale, con colonna saliscendi, con deviatore, doccetta, flessibile e soffione doccia. Tutto in ottone.

Traditional 2-handle shower/bathtub faucet with sliding rail column with diverter and handshower, with shower hose and shower head. All in chrome plated brass.



37LIRB20

Gruppo doccia con colonna saliscendi e deviatore, completa di doccetta con flessibile e soffione, tutto in ottone cromato.

Shower wall mounted mixer with deluxe sliding rail column and diverter, complete with handshower, flexible hose and shower head, all in c.p. brass



COLONNE DOCCIA FREESTANDING - COLONNE DOCCIA PER PISCINA FREESTANDING SHOWER COLUMNS - SWIMMING POOL SHOWER COLUMNS

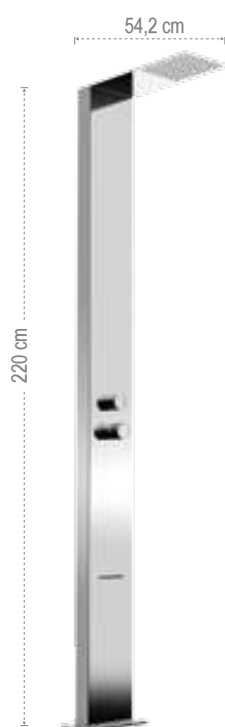

331SS

Colonna doccia da esterno in acciaio INOX a 2 vie con getto pioggia anticalcare e getto cascata, acqua calda-fredda con attacco da pavimento.

Stainless steel shower column from outside, 2 ways diverter rain jet with antilimestone and waterfall jet, mixer hot/cold water control for shower, floor water connection.



331N52

Colonna doccia girevole free-standing con miscelatore acqua calda-fredda, attacco da pavimento con soffione anticalcare Ø 30 cm. Tutta in ottone.

Free-standing swivble shower column with shower mixer hot/cold water control, floor water connection, antilimestone shower head Ø 30 cm. All in brass.

BOX INCASSO
BUILT-IN BOXKIT WELLNESS
WELLNESS KITCROMOTERAPIA
COLOR THERAPYSOFFIONI
SHOWER HEADSBOCCHE
SPOUTSPANNELLI DOCCIA
SHOWER PANELSCOLONNE DOCCIA
SHOWER COLUMNSSALISCENDI
SLIDING RAILSDOCCETTE
HAND SHOWERS

SHUT-OFF

BORDO VASCA
DECK BATH MIXERFLESSIBILI DOCCIA
SHOWER FLEXIBLES

**CODICE COLONNA
COLUMN CODE**

**CODICE COLONNA + DEVIATORE
COLUMN CODE + DIVERTER**

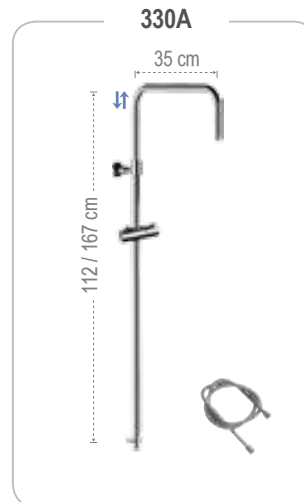
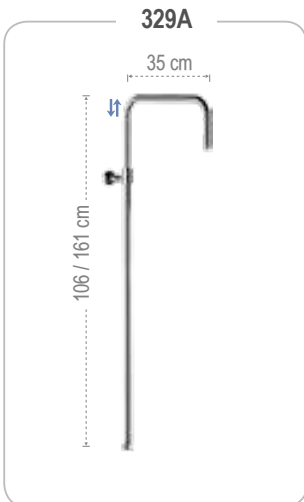
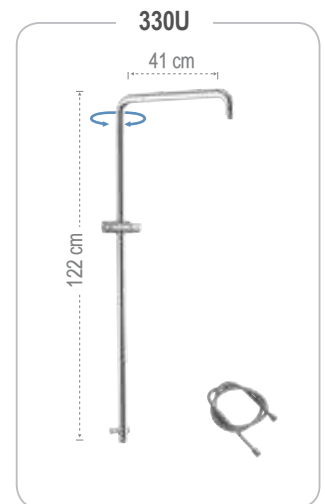
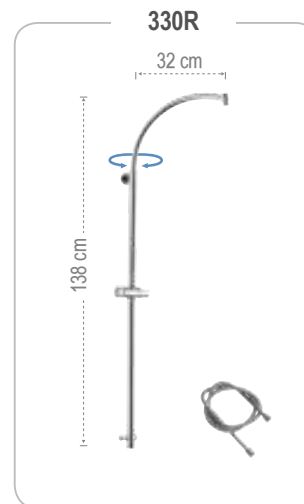
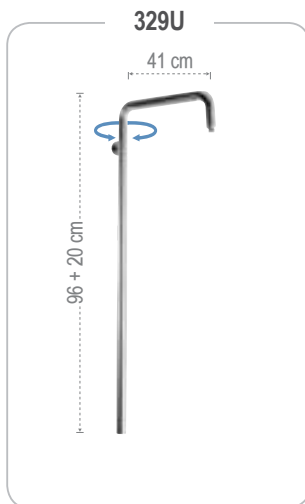
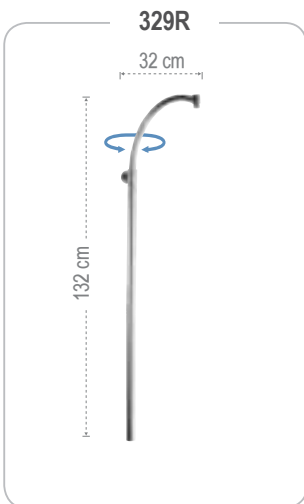
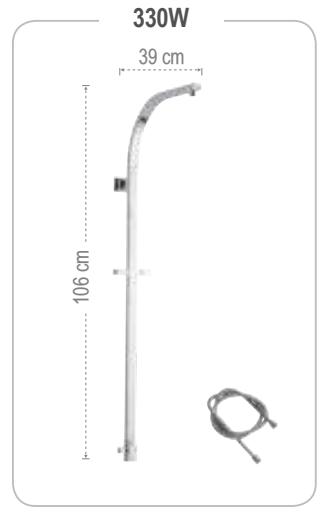

**330STU10**

Tubo in ottone per estensione dell'altezza della colonna art. 329S e 330S, lunghezza cm 10 cm.

Brass pipe for the extension of height of columns art 329S and 330S, length 10 cm.

**330STU20**

Tubo in ottone per estensione dell'altezza della colonna art. 329S e 330S, lunghezza cm 20 cm.

Brass pipe for the extension of height of columns art 329S and 330S, length 20 cm.

**330FTU20**

Tubo in ottone per estensione dell'altezza delle colonne 330F e 330L, lunghezza cm 20, Ø 22 mm.

Brass pipe for the extension of height of columns art 330F and 330L, length 20 cm for pipe Ø 22 mm.

**330NTU20**

Tubo in ottone per estensione dell'altezza delle colonne art. 330N lunghezza cm 20, Ø 25 mm.

Brass pipe for the extension of height of columns art. 330N length 20 cm for pipe Ø 25 mm.

**330FLBC**

Flessibile doccia per collegamento colonna doccia-miscelatore, attacco 1/2Fx1/2F, lunghezza cm 50.

Flexible shower hose for connection shower column - mixer, connection 1/2Fx1/2F, length cm 50.

**330RTU10****330RTU20**

Tubo in ottone cromato per estensione dell'altezza delle colonne art. 330R e 330U, con raccordo. Lunghezza 10 / 20 cm.

Brass pipe to extend the height of columns art 330R and 330U, with fitting. 10 / 20 cm length.

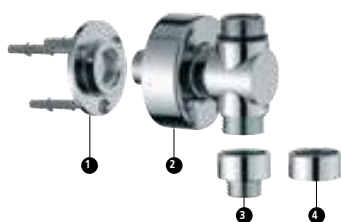
**330RA**

Presa d'acqua - supporto a muro per colonne doccia, multifunzione:

- supporto a muro alto
- presa d'acqua a muro alta
- presa d'acqua dal basso con tappo
- presa d'acqua dal basso per flessibile

Componenti:

1. Fissaggio a muro
2. Corpo principale
3. Riduzione 3/4Fx1/2M
4. Tappo 3/4F

Water punch outlet and wall bearing for shower columns, multifunction:

- high wall bearing
- high punch for water outlet
- low punch for water outlet with closing plug
- low punch for outlet water, for shower flexible hose

Components:

1. Wall fixing
2. Central body
3. Reduction 3/4Fx1/2M
4. Closing plug 3/4F

**330DEV**

Deviatore con molla e fermo, per colonne, 3/4Mx3/4Fx1/2M.

Diverter with spring and stop, for columns, 3/4M x 3/4F x 1/2M.

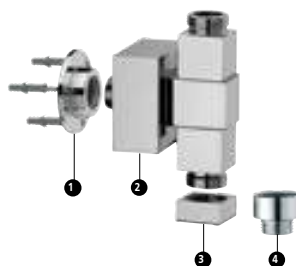
**330SRA**

Presa d'acqua - supporto a muro per colonne doccia, multifunzione:

- supporto a muro alto
- presa d'acqua a muro alta
- presa d'acqua dal basso con tappo
- presa d'acqua dal basso per flessibile

Componenti:

1. Fissaggio a muro
2. Corpo principale
3. Riduzione 3/4Fx1/2M
4. Tappo 3/4F

Water punch outlet and wall bearing for shower columns, multifunction:

- high wall bearing
- high punch for water outlet
- low punch for water outlet with closing plug
- low punch for outlet water, for shower flexible hose

Components:

1. Wall fixing
2. Central body
3. Reduction 3/4Fx1/2M
4. Closing plug 3/4F

**330SDEV**

Deviatore con molla e fermo, per colonne, 3/4Mx3/4Fx1/2M.

Squared diverter for shower columns, with spring and stop, 3/4M x 3/4F x 1/2M.

**330NRA**

Supporto per colonne da 3/4 con deviatore integrato e presa acqua inferiore 1/2.

Support for 3/4 shower column with integrated diverter and lower water punch 1/2.

**316A**

Deviatore doccia per canna livello Ø18mm 3/4Mx3/4Fx1/2M, tipo automatico con molla.

C.P. diverter for shower, for sink spout Ø 18mm, 3/4Mx3/4Fx1/2M, automatic type.

**330FSU**

Supporto inferiore per colonna da 3/4 con passaggio acqua esterno tramite collegamento 1/2.

Lower holder for column 3/4 with external water connector 1/2.

BOX INCASSO
BUILT-IN BOXKIT WELLNESS
WELLNESS KITCROMOTERAPIA
COLOR THERAPYSOFFIONI
SHOWER HEADSBOCCHE
SPOUTSPANNELLI DOCCIA
SHOWER PANELSCOLONNE DOCCIA
SHOWER COLUMNSSALISCENDI
SLIDING RAILSDOCCETTE
HAND SHOWERS

SHUT-OFF

BORDO VASCA
DECK BATH MIXERFLESSIBILI DOCCIA
SHOWER FLEXIBLES

SALISCENDI - SLIDING RAIL

SALISCENDI SLIDING RAILS





BOX INCASSO
BUILT-IN BOX

KIT WELLNESS
WELLNESS KIT

CROMOTERAPIA
COLOR THERAPY

SOFFIONI
SHOWER HEADS

BOCCHE
SPOUTS

PANNELLI DOCCIA
SHOWER PANELS

COLONNE DOCCIA
SHOWER COLUMNS

SLISCENDI
SLIDING RAILS

DOCCETTE
HAND SHOWERS

SHUT-OFF

BORDO VASCA
DECK BATH MIXER

FLESSIBILI DOCCIA
SHOWER FLEXIBLES



317R317RR

CON OPZIONI DI FINITURA  WITH FINISHING OPTIONS



317S317SS

Saliscendi SQ con doccetta ad 1 funzione tutto in ottone, flessibile 150 cm.
SQ sliding rail set with 1 function handshower all in brass, flexible hose 150 cm.



317G317MM

Saliscendi con asta tonda e fissaggio superiore scorrevole, doccetta in ottone a 1 funzione e flessibile 150 cm.
Sliding rail with round rod and sliding top fixing, 1-function brass handshower and 150 cm flexible hose.



317L323CR

Saliscendi Liberty, tutto in ottone con asta tonda e doccetta ad 1 funzione modello liberty, flessibile 150 cm.
Liberty sliding rail set all in brass, with round rod and liberty 1 function handshower, flexible hose 150 cm.



FIN 1

NO

BO

NP

NPO

FIN 2

CFP

BG

DO

SALISCENDI CON DOCCIA - SLIDING RAILS WITH HANDSHOWER

**315L318MP**

Saliscendi minimale con doccetta anticalcar in ABS a 4 funzioni con pulsante cambio getti, flessibile 150 cm.

Minimal sliding rail set with antilimestone ABS 4 function handshower, with button to change jets, flexible hose 150 cm.

**315L318CP**

Saliscendi minimale con doccetta anticalcar in ABS a 4 funzioni con pulsante cambio getti, flessibile 150 cm.

Minimal sliding rail set with antilimestone ABS 4 function handshower, with button to change jets, flexible hose 150 cm.

**317M317MD**

Saliscendi minimale con doccetta in ABS anticalcare, flessibile 150 cm.

Minimal sliding rail set with antilimestone ABS handshower, flexible hose 150 cm.

**317S317SD**

Saliscendi quadro tutto in ottone con doccetta anticalcare ad 1 funzione in ABS, flessibile in ottone cm 150.

Sliding bar all brass, with 1 function antilimestone ABS handshower, flexible hose 150 cm.

**317S317SQ**

Saliscendi quadro tutto in ottone con doccetta anticalcare ad 1 funzione in ABS, flessibile in ottone cm 150.

Sliding bar all brass, with 1 function antilimestone ABS handshower, flexible hose 150 cm.

**317R317RR**

Saliscendi e doccetta ad 1 funzione tutto ottone serie ultrapiatta rettangolare, flessibile 150 cm.

Sliding rail and 1 function handshower serie ultrafat rectangular, all in brass, flexible hose 150 cm.

**315R318MP**

Saliscendi cromato con asta tonda minimale e doccetta in ABS a 4 funzioni con pulsante per cambio dei getti, anticalcare, flessibile 150 cm.

C.p. sliding rail set with minimal round rod and 4 functions antilimestone ABS handshower with button to change the jets, flexible hose 150 cm.

**315R318CP**

Saliscendi cromato con asta tonda minimale e doccetta in ABS a 4 funzioni con pulsante cambio getti, anticalcare, flessibile 150 cm.

C.p. sliding rail set with minimal round rod and ABS antilimestone 4 functions handshower with button to change jets, flexible hose 150 cm.

**315R321HG**

Saliscendi cromato con asta tonda minimale e doccetta in ABS anticalcare con 2 funzioni, flessibile 150 cm.

C.p. sliding rail set with minimal round rod and antilimestone ABS 2 functions handshower, flexible hose 150 cm.

**315R319MO**

Saliscendi cromato asta tonda, doccetta in ABS anticalcare a 4 funzioni, flessibile 150 cm.

Sliding rail set with round rod and antilimestone 4 functions handshower and flexible hose 150 cm.

**317M319MO**

Saliscendi minimale con doccetta anticalcare in ABS a 4 funzioni, flessibile 150 cm.

Minimal sliding rail set with ABS antilimestone 4 functions handshower, flexible hose 150 cm.

**311F315P3**

Saliscendi cromato con asta tonda e doccetta anticalcare in ABS a 4 funzioni con pulsante cambio getti, flessibile 150 cm.

C.p. sliding rail set with round rod and antilimestone 4 functions handshower with button to change jets, flexible hose 150 cm.

BOX INCASSO
BUILT-IN BOXKIT WELLNESS
WELLNESS KITCROMOTERAPIA
COLOR THERAPYSOFFIONI
SHOWER HEADSBOCCHE
SPOUTSPANNELLI DOCCIA
SHOWER PANELSCOLONNE DOCCIA
SHOWER COLUMNSSALISCENDI
SLIDING RAILSDOCCETTE
HAND SHOWERS

SHUT-OFF

BORDO VASCA
DECK BATH MIXERFLESSIBILI DOCCIA
SHOWER FLEXIBLES

SALISCENDI - SLIDING RAIL



317V317RV

Saliscendi cromato con asta minimale ovale dritta e doccetta anticalcare in ABS ad 1 funzione, flessibile 150 cm.
C.p. sliding rail set with minimal oval rod and antilime ABS 1 function handshower, flexible hose 150 cm.



317V315P3

Saliscendi cromato con asta minimale ovale, doccetta in ABS anticalcare a 4 funzioni, pulsante cambio getti, anticalcare, flessibile 150 cm.
C.p. sliding rail set with minimal oval rod and antilime ABS 4 functions handshower with button to change jets, flexible hose 150 cm.



311D318F4

Saliscendi con doccetta cromata a 5 funzioni, anticalcare, flessibile 150 cm.
Sliding rail set with ABS antilime handshower 5 functions, flexible hose 150 cm.



311D318F5

Saliscendi con doccetta in ABS a 5 funzioni e getti in silicone, anticalcare, flessibile 150 cm.
Sliding rail set with ABS handshower 5 functions, antilime with silicon jets and flexible hose 150 cm.



311D315C3

Saliscendi con doccetta in ABS anticalcare ad 2 funzioni, flessibile 150 cm.
Sliding rail set with antilime ABS 2 function handshower, flexible hose 150 cm.



313E321GR

Saliscendi con asta ovale curva e doccetta in ABS anticalcare a 4 funzioni, flessibile 150 cm.
Sliding rail set with oval arch rod and antilime ABS 4 functions handshower, flexible hose 150 cm.



313P318DK

Saliscendi cromato con asta ovale arcuata e portasapone design integrato, doccetta in ABS anticalcare a 4 funzioni, flessibile 150 cm.
C.p. sliding rail set with oval arch rod and integrated design soap holder, antilime ABS 4 functions handshower, flexible hose 150 cm.



314312OV

Saliscendi cromato con barra tonda e doccetta anticalcare in ABS a 3 funzioni, flessibile 150 cm.
C.P. sliding rail set with round bar and antilime ABS 3 functions handshower, flexible hose 150 cm.



311D312

Saliscendi cromato con asta tonda e doccetta ad 1 funzione in ABS anticalcare, flessibile 150 cm.
C.P. sliding rail set with swiveling rail and 1 function ABS antilime handshower, flexible hose 150 cm.



311D311DA

Saliscendi cromato minimale con asta tonda e doccetta in ABS anticalcare ad 1 funzione, flessibile 150 cm.
C.p. sliding rail with round rod and 1 function ABS antilime handshower, flexible hose 150 cm.



311311DA

Saliscendi con doccetta in ABS anticalcare ad 1 funzione, flessibile 150 cm.
Sliding rail set with antilime ABS 1 function handshower, flexible hose 150 cm.



SALISCENDI CM 90 CON DOCCIA, ALCUNE COMBINAZIONI
SLIDING RAILS CM 90 WITH HANDSHOWERS, SOME EXAMPLE OF COUPLINGS



319D321GR

Saliscendi cm 90 con doccetta in ABS anticalcare a 4 funzioni, flessibile 200 cm.
Sliding rail set cm 90 with ABS antilimestone handshower 4 functions, flexible hose 200 cm.



319G319MO

Saliscendi cm 90 con doccetta grande a disco ABS anticalcare a 4 funzioni, flessibile 200 cm.
Sliding rail set cm 90 with ABS antilimestone handshower 4 functions, and flexible hose 200 cm.



319L323CR

Saliscendi Liberty lusso cm 90, completamente in ottone, con asta tonda e doccetta ad 1 funzione modello liberty, flessibile 200 cm.
Sliding rail set all in brass cm 90 with handshower 1 functions, flexible hose 200 cm.



SALISCENDI CON DOCCIA CON DOPPIA POSIZIONE DI SUPPORTO DOCCIA
SLIDING RAILS WITH DOUBLE HANDSHOWER SUPPORT



318C318DK

Saliscendi cromato con doppia posizione di supporto doccia e braccio alto girevole e telescopico in ottone, doccetta in ABS anticalcare a 4 funzioni, flessibile 200 cm.
C.p. sliding rail with double shower support position: rotating and telescopic high arm in brass, with antilimestone handshower 4 functions, flexible 200 cm.

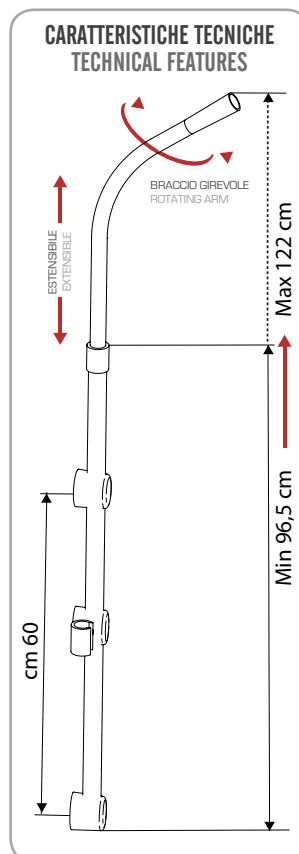

BOX INCASSO
 BUILT-IN BOX

KIT WELLNESS
 WELLNESS KIT

CROMOTERAPIA
 COLOR THERAPY

SOFFIONI
 SHOWER HEADS

BOCCHE
 SPOUTS

PANNELLI DOCCIA
 SHOWER PANELS

COLONNE DOCCIA
 SHOWER COLUMNS

**SALISCENDI
 SLIDING RAILS**

DOCCETTE
 HAND SHOWERS

SHUT-OFF

BORDO VASCA
 DECK BATH MIXER

FLESSIBILI DOCCIA
 SHOWER FLEXIBLES

ASTA IN OTTONE CROMATO
ROD IN CHROME PLATED BRASS



315L333

Saliscendi cromato con asta tonda minimale Ø 22 mm e centralina in ABS, con flessibile in ottone 150 cm senza doccetta, in scatola con finestra. Altezza 69 cm.

Sliding rail set with round minimal rod Ø 22 mm and sliding shower holder, with brass flexible hose 150 cm, without handshower, in box. Height 69 cm.



317M333

Saliscendi in ottone con asta tonda minimale Ø 18 mm e centralina in ABS, con flessibile in ottone 150 cm senza doccetta, in scatola con finestra. Altezza 60 cm.

Sliding rail set in Brass with round minimal rod Ø 18 mm and ABS sliding shower holder, with brass flexible hose 150 cm, without handshower, in box. Height 60 cm.



315R333

Saliscendi in ottone con asta tonda minimale Ø 25 mm e centralina in ABS, con flessibile in ottone 150 cm senza doccetta, in scatola con finestra. Altezza 69 cm.

Sliding rail set in Brass with round minimal rod Ø 25 mm and sliding shower holder, with brass flexible hose 150 cm, without handshower, in box. Height 69 cm.



311S333

Saliscendi cromo-satinato con asta tonda Ø 25 mm e centralina in ABS, con flessibile in ottone 150 cm, senza doccetta, in scatola con finestra. Altezza 66 cm.

Sliding rail set in chrome-satin with round rod Ø 25 mm and ABS sliding shower holder, with brass flexible hose, without handshower, in box. Height 66 cm.



319R333

Con asta 90 cm.
With rod 90 cm.



311F333

Saliscendi cromato con asta tonda Ø 25 mm e centralina in ABS, con flessibile in ottone 150 cm, senza doccetta, in scatola con finestra. Altezza 57,5 cm.

Brass sliding rail set with round rod Ø 25 mm and ABS sliding shower holder, with brass flexible hose 150 cm, without handshower, in box. Height 57,5 cm.



311333

Saliscendi cromato con asta tonda Ø 25 mm e centralina in ABS, flessibile in ottone 150 cm, senza doccetta, in scatola con finestra. Altezza 62 cm.

Sliding rail set with round rod Ø 25 mm and ABS sliding shower holder, with brass flexible hose 150 cm, without handshower, in box. Height 62 cm.



319F333

Con asta 105 cm.
With rod 105 cm.



**317L333**

Saliscendi Liberty lusso tutta in ottone, asta tonda Ø 25 mm con centralina, con flessibile 150 cm, senza doccetta, in scatola con finestra. Altezza 60 cm.

Deluxe sliding rail Liberty line all in brass, round rod Ø 25 mm with sliding shower holder, flexible hose 150 cm, without handshower, in box with window. Height 60 cm.

**319L333**

Con asta 90 cm.
With rod 90 cm.

**317S333**

Saliscendi completamente in ottone da barra quadrata con centralina, flessibile 150 cm, senza doccetta, in scatola con finestra. Altezza 70 cm.

Sliding rail set all in brass, squared rod with sliding shower holder, flexible hose 150 cm, without handshower, in box. Height 70 cm.

**317N333**

Saliscendi tutto in ottone, asta tonda Ø 25 mm con centralina, flessibile 150 cm, senza doccetta, in scatola con finestra. Altezza 70 cm.

Deluxe sliding rail all in brass, with round rod Ø 25 mm and sliding shower holder, flexible hose 150 cm, without handshower, in box. Height 70 cm.



SUPPORTO
REGOLABILE
ADJUSTABLE
HOLDER

**317G333**

Saliscendi tutto in ottone, asta tonda Ø 25 mm e centralina, con flessibile 150 cm, senza doccetta, in scatola con finestra. Altezza 70 cm.

Deluxe sliding rail, all in brass, with round rod Ø 25 mm and sliding shower holder, with flexible hose 150 cm, without handshower, in box. Height 70 cm.

**319G333**

Con asta 87 cm.
With rod 87 cm.

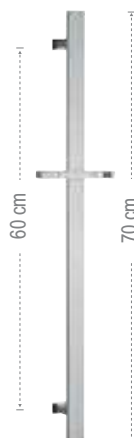
**317R333**

Saliscendi lusso Flat ultrapiatto tutto in ottone, asta rettangolare piatta larga mm 30 con centralina, flessibile 150 cm, senza doccetta, in scatola con finestra. Altezza 70 cm.

Deluxe sliding rail Flat line all in brass, rectangular flat rod large mm 30 and sliding shower holder, flexible hose 150 cm, without handshower, in box with window. Height 70 cm.

**317V333**

Saliscendi cromato con asta minimale ovale dritta e centralina in ABS, con flessibile in ottone 150 cm senza doccetta, in scatola con finestra. Altezza 65 cm.

C.p. sliding rail set with minimal oval rod and ABS sliding shower holder, with brass flexible hose 150 cm without handshower, in box. Height 65 cm.

BOX INCASSO
BUILT-IN BOXKIT WELLNESS
WELLNESS KITCROMOTERAPIA
COLOR THERAPYSOFFIONI
SHOWER HEADSBOCCHE
SPOUTSPANNELLI DOCCIA
SHOWER PANELSCOLONNE DOCCIA
SHOWER COLUMNSSALISCENDI
SLIDING RAILSDOCCETTE
HAND SHOWERS

SHUT-OFF

BORDO VASCA
DECK BATH MIXERFLESSIBILI DOCCIA
SHOWER FLEXIBLES

SALISCENDI - SLIDING RAIL



311D333

Saliscendi cromato con asta tonda Ø 25 mm e centralina in ABS, flessibile in ottone 150 cm, senza doccetta, in scatola con finestra. Altezza 60 cm.

Sliding rail set with round rod Ø 25 mm and ABS sliding shower holder, with brass flexible hose, without handshower, in box. Height 60 cm.



319D333

Con asta 94 cm.
With rod 94 cm.



313E333

Saliscendi cromato con asta ovale arcuata e centralina in ABS, con flessibile in ottone 150 cm, senza doccetta, in scatola con finestra. Altezza 74 cm.

Sliding rail set with oval arch rod and ABS sliding shower holder, with brass flexible hose 150 cm, without handshower, in box. Height 74 cm.



314333

Saliscendi cromato con asta tonda Ø 18 mm e centralina in ABS, con flessibile in ottone 150 cm, senza doccetta, in scatola con finestra. Altezza 66 cm.

Sliding rail set with round rod Ø 18 mm with sliding shower column, brass flexible hose 150 cm, without handshower, in box. Height 66 cm.



PORTASAPONE - SOAP HOLDER

**319PR**

Portasapone cromato per saliscendi con asta tonda Ø 25.

C.p. soap-holder for sliding rail with round rod Ø 25.

**311PC**

Portasapone cromato economico per saliscendi tipo art. 310, 311 e 314, per asta Ø 25 mm e Ø 18 mm.

Chrome plated soap holder for sliding rails like art. 310, 311 and 314, for round rod Ø 25 mm and Ø 18 mm.

**311PT**

Portasapone trasparente economico per saliscendi tipo art. 310, 311 e 314, per asta Ø 25 mm e Ø 18 mm.

Transparent soap holder for sliding rails like art. 310, 311 and 314, for round rod Ø 25 mm and Ø 18 mm.

**311PS**

Portasapone per saliscendi art. 310 e 311, per asta Ø 24 o 25 mm.

Soap holder for sliding rail art. 310 or 311, for round rod Ø 24 or 25 mm.

**313PO**

Portasapone per saliscendi art. 313 per asta ovale.

Soap holder for sliding rail art. 313 for oval rod.

**317PM**

Portasapone cromato per saliscendi con asta tonda Ø 18.

C.P. soap-holder for sliding rail with round rod Ø 18.

BOX INCASSO
BUILT-IN BOXKIT WELLNESS
WELLNESS KITCROMOTERAPIA
COLOR THERAPYSOFFIONI
SHOWER HEADSBOCCHE
SPOUTSPANNELLI DOCCIA
SHOWER PANELSCOLONNE DOCCIA
SHOWER COLUMNSSALISCENDI
SLIDING RAILSDOCCETTE
HAND SHOWERS

SHUT-OFF

BORDO VASCA
DECK BATH MIXERFLESSIBILI DOCCIA
SHOWER FLEXIBLES

DOCCETTE - HAND SHOWERS

DOCCETTE HANDSHOWERS





FLESSIBILI DOCCIA
SHOWER FLEXIBLES

BORDO VASCA
DECK BATH MIXER

SHUT-OFF

DOCCETTE
HAND SHOWERS

SALISCENDI
SLIDING RAILS

COLONNE DOCCIA
SHOWER COLUMNS

PANNELLI DOCCIA
SHOWER PANELS

BOCCHE
SPOUTS

SOFFIONI
SHOWER HEADS

CROMOTERAPIA
COLOR THERAPY

KIT WELLNESS
WELLNESS KIT

BOX INCASSO
BUILT-IN BOX

CON OPZIONI DI FINITURA WITH FINISHING OPTIONS

317MM



18,5 cm

Doccetta Minimal ad 1 funzione completamente in ottone.
1 function minimal handshower, completely in brass.



SENZA SCATOLA WITHOUT BOX	CON SCATOLA WITH BOX
317MM	317MMX

317SS



20 cm

Doccetta quadrata ad 1 funzione, in ottone.
1 function handshower, in brass.



SENZA SCATOLA WITHOUT BOX	CON SCATOLA WITH BOX
317SS	317SSX

323CR



18,5 cm

Doccetta "Liberty" in ottone.
Brass "Liberty" handshower.



SENZA SCATOLA WITHOUT BOX	CON SCATOLA WITH BOX
323CR	323CRX

FIN 1

NO

BO

NP

NPO

FIN 2

CFP

BG

DO

317RR



21 cm

Doccetta rettangolare Flat, 1 funzione, in ottone.
1 function ultraflat rectangular handshower, in brass.



SENZA SCATOLA WITHOUT BOX	CON SCATOLA WITH BOX
317RR	317RRX

318MP



25 cm

Doccetta cromata 4 funzioni, pulsante cambio getti, anticalcare.
C.P. handshower 4 functions, button to change the jets, antilimestone.



SENZA SCATOLA WITHOUT BOX	CON SCATOLA WITH BOX
318MP	318MPX

318MPNO



25 cm

Doccetta nera 4 funzioni, pulsante cambio getti, anticalcare.
C.P. handshower 4 functions, button to change the jets, antilimestone.



SENZA SCATOLA WITHOUT BOX	CON SCATOLA WITH BOX
318MPNO	318MPNOX
€ 30,70	

318 CP



24,5 cm

Doccetta cromata, 4 funzioni, pulsante per cambio dell'intensità del getto, anticalcare.
C.p. handshower 4 functions, button to change intensity of the jets, antilimestone.



SENZA SCATOLA WITHOUT BOX	CON SCATOLA WITH BOX
318CP	318CPX

318CPNO



24,5 cm

Doccetta nera, 4 funzioni, pulsante per cambio dell'intensità del getto, anticalcare.
C.p. handshower 4 functions, button to change intensity of the jets, antilimestone.



SENZA SCATOLA WITHOUT BOX	CON SCATOLA WITH BOX
318CPNO	318CPNOX
€ 41,10	

317MD



20,5 cm

Doccetta minimal ad 1 funzione, anticalcare.
C.P. minimal handshower 1 function antilimestone.



SENZA SCATOLA WITHOUT BOX	CON SCATOLA WITH BOX
317MD	317MDX

317SD



20,5 cm

Doccetta quadrata ad 1 funzione in ABS.
1 function ABS handshower.



SENZA SCATOLA WITHOUT BOX	CON SCATOLA WITH BOX
317SD	317SDX

315P3



25 cm

Doccetta cromata, 4 funzioni, pulsante per cambio getti, anticalcare.
C.P. handshower 4 functions, button to change the jets, antilimestone.



SENZA SCATOLA WITHOUT BOX	CON SCATOLA WITH BOX
315P3	315P3X

319MO



20 cm

Doccetta cromata minimale 4 funzioni, idromassaggio ed anticalcare.
C.p. handshower 4 functions, hydromassage, antilimestone.



SENZA SCATOLA WITHOUT BOX	CON SCATOLA WITH BOX
319MO	319MOX

317SQ



22,5 cm

Doccetta cromata Qubika ad 1 funzione, anticalcare.
C.p. Qubika handshower, 1 function, antilimestone.



SENZA SCATOLA WITHOUT BOX	CON SCATOLA WITH BOX
317SQ	317SQX

317MR



22,5 cm

Doccetta cromata arcuata ad 1 funzione, anticalcare.
C.p. arch handshower, 1 function antilimestone.



SENZA SCATOLA WITHOUT BOX	CON SCATOLA WITH BOX
317MR	317MRX

318CA



25 cm

Doccetta cromata "cascata" a 2 funzioni, anticalcare.
C.p. "waterfall" handshower 2 functions, antilimestone.



SENZA SCATOLA WITHOUT BOX	CON SCATOLA WITH BOX
318CA	318CAX

318F4



24 cm

Doccetta cromata a 5 funzioni, anticalcare.
C.p. handshower 5 functions, antilimestone.



SENZA SCATOLA WITHOUT BOX	CON SCATOLA WITH BOX
318F4	318F4X

318F5



25 cm

Doccetta cromata a 5 funzioni, anticalcare.
C.p. handshower 5 functions, antilimestone.



SENZA SCATOLA WITHOUT BOX	CON SCATOLA WITH BOX
318F5	318F5X

321F5



23 cm

Doccetta cromata 5 funzioni, anticalcare.
C.P. handshower 5 functions, antilimestone.



SENZA SCATOLA WITHOUT BOX	CON SCATOLA WITH BOX
321F5	321F5X

321HG



23 cm

Doccetta cromata minimale a 2 funzioni, idromassaggio ed anticalcare.
C.p. minimal handshower 2 functions hydromassage, antilimestone.



SENZA SCATOLA WITHOUT BOX	CON SCATOLA WITH BOX
321HG	321HGX

318DK



25,5 cm

Doccetta cromata a 4 funzioni, idromassaggio ed anticalcare.
C.p. handshower 4 functions, hydromassage, antilimestone.



SENZA SCATOLA WITHOUT BOX	CON SCATOLA WITH BOX
318DK	318DKX

317RV



24,5 cm

Doccetta cromata ovale ad 1 funzione, anticalcare.
C.p. oval handshower 1 function, antilimestone.



SENZA SCATOLA WITHOUT BOX	CON SCATOLA WITH BOX
317RV	317RVX

317MT



20 cm

Doccetta "Triangle" ad 1 funzione, completamente in ottone.
1 function handshower "Triangle", completely in chrome plated brass.



SENZA SCATOLA WITHOUT BOX	CON SCATOLA WITH BOX
317MT	317MTX

318XF



27 cm

Doccetta cromata a 5 funzioni, idromassaggio ed anticalcare.
C.p. handshower 5 functions hydromassage, antilimestone.



SENZA SCATOLA WITHOUT BOX	CON SCATOLA WITH BOX
318XF	318XFx

315C3



21 cm

Doccetta idromassaggio anticalcare a 2 funzioni in ABS.
2 functions ABS handshower, hydromassage, antilimestone.



SENZA SCATOLA WITHOUT BOX	CON SCATOLA WITH BOX
315C3	315C3X

315FO



24 cm

Doccetta anticalcare idromassaggio a 3 funzioni.
C.P. handshower 3 functions, hydromassage, antilimestone.



SENZA SCATOLA WITHOUT BOX	CON SCATOLA WITH BOX
315FO	315FOX

312RO



19 cm

Doccetta idromassaggio anticalcare a 3 funzioni.
C.P. handshower 3 functions, hydromassage, antilimestone.



SENZA SCATOLA WITHOUT BOX	CON SCATOLA WITH BOX
312RO	312ROX

312OV



19,5 cm

Doccetta idromassaggio anticalcare a 3 funzioni.
C.P. handshower 3 functions, hydromassage, antilimestone.



SENZA SCATOLA WITHOUT BOX	CON SCATOLA WITH BOX
312OV	312OVX

321GR



24 cm

Doccetta idromassaggio anticalcare a 4 funzioni.
C.P. handshower 4 functions, hydromassage, antilimestone.



SENZA SCATOLA WITHOUT BOX	CON SCATOLA WITH BOX
321 GR	321 GRX

BOX INCASSO
BUILT-IN BOX

KIT WELLNESS
WELLNESS KIT

CROMOTERAPIA
COLOR THERAPY

SOFFIONI
SHOWER HEADS

BOCCHE
SPOUTS

PANNELLI DOCCIA
SHOWER PANELS

COLONNE DOCCIA
SHOWER COLUMNS

SALISCENDI
SLIDING RAILS

DOCCETTE
HAND SHOWERS

SHUT-OFF

BORDO VASCA
DECK BATH MIXER

FLESSIBILI DOCCIA
SHOWER FLEXIBLES

DOCCETTE - HAND SHOWERS

321SC



..... 21 cm

Doccetta idromassaggio anticalcare a 5 funzioni.
C.P. handshower 5 functions hydromassage, antilimestone.



SENZA SCATOLA WITHOUT BOX	CON SCATOLA WITH BOX
321 SC	321 SCX

312



..... 23,5 cm

Doccetta cromata, 1 funzione, anticalcare.
1 function c.p. handshower, antilimestone.



SENZA SCATOLA WITHOUT BOX	CON SCATOLA WITH BOX
312	312 X

315C1



..... 20 cm

Doccetta idromassaggio anticalcare, 1 funzione.
1 function c.p. handshower antilimestone.



SENZA SCATOLA WITHOUT BOX	CON SCATOLA WITH BOX
315 C1	315 C1X

311DA



..... 20 cm

Doccetta cromata ad 1 funzione, anticalcare.
C.P. handshower 1 function, antilimestone.



SENZA SCATOLA WITHOUT BOX	CON SCATOLA WITH BOX
311 DA	311 DAX

311DABI



..... 20 cm

Doccetta bianca ad 1 funzione, anticalcare.
White handshower 1 function, antilimestone.



SENZA SCATOLA WITHOUT BOX	CON SCATOLA WITH BOX
311 DA BI	311 DA BIX

324CR



..... 17,5 cm

Doccetta in plastica cromata.
C.p. plastic handshower.



SENZA SCATOLA WITHOUT BOX
324 CR

324ECR



..... 18 cm

Doccetta in plastica cromata.
C.p. plastic handshower.



SENZA SCATOLA WITHOUT BOX
324 ECR

324



..... 17,5 cm

Doccetta in plastica bianca e nera "Rombo".
Plastic handshower, coloured in black or white, "Rhomb" shaped.



SENZA SCATOLA WITHOUT BOX
324

KIT SUPPORTO CON PRESA ACQUA E DOCCETTA HANDSHOWER AND WATER PUNCH WITH SHOWER HOLDER KIT

CON OPZIONI DI FINITURA  WITH FINISHING OPTIONS



337M317MM

Set doccia minimale composto da: presa acqua con supporto lusso in ottone, doccetta in ottone e flessibile 150 cm.
Minimal shower set including: water punch and shower holder in brass, brass handshower and 150 cm flexible hose.



337Q317SS

Set doccia quadrato composto da: presa acqua con supporto lusso in ottone, doccetta in ottone e flessibile 150 cm.
Squared shower set including: water punch and shower holder in brass, brass handshower and 150 cm flexible hose.



337LI323CR

Set doccia Liberty composto da: presa acqua con supporto in ottone, doccetta in ottone e flessibile 150 cm.
Liberty shower set including: water punch and shower holder in brass, brass handshower and 150 cm flexible hose.

FIN 1

NO

BO

NP

NPO

FIN 2

CFP

BG

DO



337M317MD

Set doccia minimale composto da: presa acqua con supporto lusso in ottone, doccetta cromata, anticalcare con getti in silicone e flessibile 150 cm.
Minimal shower set including: water punch and shower holder in brass, handshower antilimestone with silicon jets and 150 cm flexible hose.



337M318MP

Set doccia composto da: presa acqua con supporto lusso in ottone, doccetta cromata a 4 funzioni, con pulsante per cambio dei getti, anticalcare con getti in silicone e flessibile 150 cm.
Shower set including: water punch and shower holder in brass, handshower 4 functions with button to change the jets, antilimestone with silicon jets and 150 cm flexible hose.



337M318F4

Set doccia composto da: presa acqua con supporto lusso in ottone, doccetta cromata 5 funzioni, anticalcare con getti in silicone e flessibile 150 cm.
Shower set including: water punch and shower holder in brass, 5 functions handshower antilimestone with silicon jets and 150 cm flexible hose.



337M319MO

Set doccia composto da: presa acqua con supporto lusso in ottone, doccetta cromata 4 funzioni, idromassaggio, anticalcare con getti in silicone e flessibile 150 cm.
Shower set including: water punch and shower holder in brass, 4 functions handshower antilimestone with silicon jets, hydromassage, and 150 cm flexible hose.



337Q317SD

Set doccia quadrato composto da: presa acqua con supporto lusso in ottone, doccetta anticalcare in ABS, e flessibile 150 cm.
Shower set including: water punch and shower holder in brass, antilimestone ABS handshower and 150 cm flexible hose.



337Q317SQ

Set doccia Qubika composto da: presa acqua con supporto lusso in ottone, doccetta cromata anticalcare con getti in silicone e flessibile 150 cm.
Qubika shower set including: water punch and shower holder in brass, handshower antilimestone with silicon jets and 150 cm flexible hose.

BOX INCASSO
BUILT-IN BOXKIT WELLNESS
WELLNESS KITCROMOTERAPIA
COLOR THERAPYSOFFIONI
SHOWER HEADSBOCCHE
SPOUTSPANNELLI DOCCIA
SHOWER PANELSCOLONNE DOCCIA
SHOWER COLUMNSSALISCENDI
SLIDING RAILSDOCCETTE
HAND SHOWERS

SHUT-OFF

BORDO VASCA
DECK BATH MIXERFLESSIBILI DOCCIA
SHOWER FLEXIBLES

DOCCETTE - HAND SHOWERS



337Q318CP

Set doccia quadrato composto da: presa acqua con supporto lusso in ottone, doccetta cromata a 4 funzioni, con pulsante per cambio dei getti, anticalcare con getti in silicone e flessibile 150 cm.

Shower set including: water punch and shower holder in brass, handshower 4 functions with button to change the jets, antilimestone with silicon jets and 150 cm flexible hose.



337M318CP

Set doccia composto da: presa acqua con supporto lusso in ottone, doccetta cromata a 4 funzioni, con pulsante per cambio dei getti, anticalcare con getti in silicone e flessibile 150 cm.

Shower set including: water punch and shower holder in brass, handshower 4 functions with button to change the jets, antilimestone with silicon jets and 150 cm flexible hose.



PRESE ACQUA - WATER PUNCH

CON OPZIONI DI FINITURA



WITH FINISHING OPTIONS



309W

Attacco presa acqua da 1/2, tipo rettangolare.
1/2 rectangular wall connection.



309L

Attacco presa acqua da 1/2, tipo rotondo pesante.
Brass wall connector, round heavy type, 1/2Fx1/2M, for shower.



309S

Attacco presa acqua da 1/2Fx1/2M, tipo quadrato, pesante.
Brass wall water punch connector, squared and heavy type, 1/2Fx1/2M, for shower.

FIN 1

NO

BO

NP

NPO

FIN 2

CFP

BG

DO



309

Angolo 1/2Mx1/2M in ottone, con rosone scorrevole in ottone.
Brass angle 1/2Mx1/2M for shower, with Brass sliding flange.



309RL6

Raccordo doccia 1/2" a risparmio idrico con limitatore di portata da 6 litri al minuto.
Brass connection, water saving program with flow reduction at 6 liters by minute.



309RL8

Raccordo doccia 1/2" a risparmio idrico con limitatore di portata da 8 litri al minuto.
Brass connection, water saving program with flow reduction at 8 liters by minute.



309NR

Raccordo doccia da 1/2" con valvola di non ritorno.
1/2" shower connection with no return valve.

PRESE ACQUA CON SUPPORTO - WATER PUNCH WITH SHOWER HOLDER

CON OPZIONI DI FINITURA  WITH FINISHING OPTIONS**337X**

Preso acqua e supporto lusso minimale in ottone ad incasso, con rosone ultrapiatto per flessibile con attacco conico.

Water punch and minimal shower holder in brass with ultraflat flange, for built-in and conical nut flexible hose.

**337M**

Preso acqua in ottone cromato, con supporto per doccia. Per flessibile da 1/2" con attacco conico.

C.p. brass wall connection with handshower holder. For 1/2" flexible hose with conical connection.

**337Q**

Preso acqua squadrata in ottone cromato, con supporto per doccia. Per flessibile da 1/2" con attacco conico.

C.p. brass squared wall connection with handshower holder. For 1/2" flexible hose with conical connection.

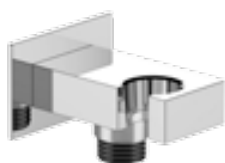
**337W**

Preso acqua rettangolare in ottone cromato, con supporto per doccia. Per flessibile da 1/2" con attacco conico.

C.p. brass rectangular wall connection with handshower holder. For 1/2" flexible hose with conical connection.

**337S**

Preso acqua squadrata in ottone cromato, con supporto orientabile per doccia. Per flessibile da 1/2" con attacco conico.

C.p. brass squared wall connection with adjustable handshower holder. For 1/2" flexible hose with conical connection.

**337LI**

Supporto snodato per doccia in ottone cromato con presa acqua.

C.p. brass adjustable shower holder with water punch connector.

FIN 1

NO

BO

NP

NPO

FIN 2

CFP

BG

DO

RUBINETTI DI ARRESTO CON SUPPORTO - ANGLE VALVES WITH HOLDER

CON OPZIONI DI FINITURA  WITH FINISHING OPTIONS**338M**

Rubinetto d'arresto serie "Minimal", con supporto doccia in ottone, per flessibile con attacco conico.

Minimal series angle valve with brass handshower holder, for flexible hose with conical connection.

**338Q**

Rubinetto d'arresto quadrato, con supporto doccia in ottone, per flessibile con attacco conico.

Square angle valve with brass handshower holder, for flexible hose with conical connection.

FIN 1

NO

BO

NP

NPO

FIN 2

CFP

BG

DO

**336L**

Rubinetto d'arresto serie "Minimal", con supporto doccia in ottone, per flessibile con attacco conico.

Brass minimal angle valve with shower holder, for conical nut flexible hose.

**336S**

Rubinetto d'arresto serie "SQ", con supporto doccia in ottone, flessibile con attacco conico.

Brass squared angle valve with shower holder, for conical nut flexible hose.

BOX INCASSO
BUILT-IN BOXKIT WELLNESS
WELLNESS KITCROMOTERAPIA
COLOR THERAPYSOFFIONI
SHOWER HEADSBOCCHE
SPOUTSPANNELLI DOCCIA
SHOWER PANELSCOLONNE DOCCIA
SHOWER COLUMNSSALISCENDI
SLIDING RAILSDOCCETTE
HAND SHOWERS

SHUT-OFF

BORDO VASCA
DECK BATH MIXERFLESSIBILI DOCCIA
SHOWER FLEXIBLES

SUPPORTI DOCCIA - SHOWER HOLDERS

CON OPZIONI DI FINITURA  WITH FINISHING OPTIONS**339SOM**

Supporto "minimale" in ottone per flessibile con attacco conico.
Minimal shower holder in brass, for conical nut flexible hose.

**339SO**

Supporto "Lux" in ottone, per flessibile con attacco conico.
Shower holder in brass "Lux", for conical shower flexible hose.

**339SOS**

Supporto fisso quadrato in ottone per flessibile con attacco conico.
Squared shower holder in brass, for conical nut flexible hose.

**338**

Supporto snodato in ottone "Liberty" per duplex esterno, con attacco conico.
Brass adjustable shower holder "Liberty", external duplex, for conical nut flexible hose.

**339SS**

Supporto snodato a braccio serie "SQ", in ottone, per flessibile con attacco conico.
Adjustable shower holder serie "SQ" in brass, for conical nut flexible hose.

FIN 1

NO

BO

NP

NPO

FIN 2

CFP

BG

DO

**339**

Supporto snodato in ABS cromato, per flessibile con attacco conico.
Adjustable shower holder in c.p. Abs, for conical nut flexible hose.

**339F**

Supporto fisso in ABS cromato, per flessibile con attacco conico.
Shower holder in c.p. Abs, for conical nut flexible hose.

**339FBI**

Supporto fisso in ABS bianco, per flessibile con attacco conico.
Shower holder in white Abs, for conical nut flexible hose.

**339R3**

Supporto fisso a 3 posizioni in ABS cromato per flessibile con attacco conico.
Shower holder 3 positions in CP Abs, for conical nut flexible hose.

**339N**

Supporto snodato a braccio serie "Minimal", in ABS cromato, per flessibile con attacco conico.
Adjustable shower holder serie "Minimal" in c.p. Abs, for conical nut flexible hose.

**339S**

Supporto snodato a braccio serie "SQ", in ABS cromato, per flessibile con attacco conico.
Adjustable shower holder serie "SQ" in c.p. Abs, for conical nut flexible hose.

**339L**

Supporto "minimale" snodato a braccio in ABS cromato, per flessibile con attacco conico.
Adjustable "Minimal" shower holder in c.p. Abs, for conical nut flexible hose.

**335P**

Supporto snodato in ABS cromato, per flessibile con attacco conico e zigrinato.
Adjustable shower holder in c.p. Abs, for conical nut flexible hose.

**336**

Supporto snodato in ottone per duplex esterno per art. 328.
Brass adjustable shower holder, for external duplex per art. 328.

**325**

Curva in ottone per doccetta, 1/2".
Elbow connection in brass for handshower, 1/2".

**32507**

Supporto per doccetta estraibile per bordo lavello e bordo vasca, modello a base tonda.
Support for extensible handshower for deck bath and deck sink, round base model.

**325S07**

Supporto dritto per doccetta estraibile per bordo lavello e bordo vasca, modello a base quadra.
Straight support for extensible handshower for deck bath and deck sink, squared base model.

LINEA PARRUCCHIERE - HAIRDRESSER LINE



K66
Mixer per acconciatore completo con doccia estraibile.
Barber mixer complete with pull-out shower.

CR € 82,70



K66DONE
Doccetta per parrucchiere, nera.
Handshower for hairdresser, black.

SENZA SCATOLA WITHOUT BOX	CON SCATOLA WITH BOX
K66DONE	K66DONEX



K66CO
Miscelatore per parrucchiere.
Single-lever mixer for hairdresser.



K66SU
Supporto per doccetta parrucchiere.
Holder for hairdresser handshower.



K66FL
Flessibile in plastica grigio metallizzato, M15x1 girevole, 3/8F, cm 120.
Flexible hose in metallic grey PVC for hairdresser handshower, M15x1 swiveling, 3/8F, cm 120



K66FLNY
Flessibile in nylon nero, M15x1 girevole, 3/8F, cm 120.
Flexible hose in black nylon for hairdresser handshower, M15x1 swiveling, 3/8F, cm 120.



K66

BOX INCASSO
BUILT-IN BOXKIT WELLNESS
WELLNESS KITCROMOTERAPIA
COLOR THERAPYSOFFIONI
SHOWER HEADSBOCCHE
SPOUTSPANNELLI DOCCIA
SHOWER PANELSCOLONNE DOCCIA
SHOWER COLUMNSSALISCENDI
SLIDING RAILSDOCCETTE
HAND SHOWERS

SHUT-OFF

BORDO VASCA
DECK BATH MIXERFLESSIBILI DOCCIA
SHOWER FLEXIBLES

SHUT-OFF

SHUT-OFF



Le doccette shut-off e i kit shut-off sono indicati per l'igiene personale.
Il pulsante sull'impugnatura delle doccette permette di gestire l'attivazione del
flusso dell'acqua in modo pratico e sicuro.

*Shut-off spray and shut-off shower sets are suitable for personal hygiene.
The button on the handle of the hand shower allows you to control the
activation of the water flow in a practical and safe way.*

BOX INCASSO
BUILT-IN BOXKIT WELLNESS
WELLNESS KITCROMOTERAPIA
COLOR THERAPYSOFFIONI
SHOWER HEADSBOCCHE
SPOUTSPANNELLI DOCCIA
SHOWER PANELSCOLONNE DOCCIA
SHOWER COLUMNSSALISCENDI
SLIDING RAILSDOCCETTE
HAND SHOWERS

SHUT-OFF

BORDO VASCA
DECK BATH MIXERFLESSIBILI DOCCIA
SHOWER FLEXIBLES

SHUT-OFF PROGRESSIVO - PROGRESSIVE SHUT-OFF

CON OPZIONI DI FINITURA WITH FINISHING OPTIONS



Q64

Miscelatore shut-off quadrato con cartuccia progressiva, apertura su acqua fredda e passaggio ad acqua calda tramite rotazione di maniglia unica, comprensivo di doccetta shut-off 332OS e flessibile cm 120.

Shut-off square mixer with progressive cartridge, opening with cold water, switching on hot water by rotating one single handle including shut-off 332OS and flexible hose 120 cm.



N64W

Miscelatore shut-off serie Minimal con cartuccia progressiva, apertura su acqua fredda e passaggio ad acqua calda tramite rotazione di maniglia unica, comprensivo di doccetta shut-off 332OW e flessibile cm 120.

Shut-off mixer Minimal series with progressive cartridge, opening with cold water, switching on hot water by rotating one single handle including shut-off 332OW and flexible hose 120 cm.

FIN 1 NO BO NP NPO FIN 2 CFP BG DO

MISCELATORI INCASSO - BUILT-IN MIXERS



N63

Miscelatore incasso per shut-off.
Built-in shut-off mixer.



Z63

Miscelatore incasso per shut-off.
Built-in shut-off mixer.



L63

Miscelatore incasso per shut-off.
Built-in shut-off mixer.



Q63

Miscelatore incasso per shut-off.
Built-in shut-off mixer.



S633

Miscelatore incasso per shut-off.
Built-in shut-off mixer.

MISCELATORI SHUT-OFF - SHUT-OFF MIXERS



D60

Miscelatore incasso shut-off serie Dream comprensivo di: doccetta shut-off 332OL, supporto doccia presa acqua su piastra in ottone e flessibile cm 120.
Built-in shower mixer set Dream series including: shut-off 332OL, shower holder water punch on flange all in brass and flexible hose cm 120.



N60

Miscelatore incasso shut-off serie Minimal comprensivo di: doccetta shut-off 332OL, supporto doccia presa acqua su piastra in ottone e flessibile cm 120.
Built-in shut-off mixer set Minimal series including: shut-off 332OL, shower holder water punch on flange, all in brass and flexible hose cm 120.



I60

Miscelatore incasso shut-off serie Infinity comprensivo di: doccetta shut-off 332OL, supporto doccia presa acqua su piastra in ottone e flessibile cm 120.
Built-in shut-off mixer set Infinity series including: shut-off 332OL, shower holder water punch on flange, all in brass and flexible hose cm 120.



D60W

Miscelatore incasso shut-off serie Dream comprensivo di: doccetta shut-off 332OW, supporto doccia-presa acqua su piastra in ottone e flessibile cm 120.
Built-in shower mixer set Dream series including: shut-off 332OW, shower holder water punch on flange all in brass and flexible hose cm 120.



N60W

Miscelatore incasso shut-off serie Minimal comprensivo di: doccetta shut-off 332OW, supporto doccia presa acqua su piastra in ottone e flessibile cm 120.
Built-in shut-off mixer set Minimal series including: shut-off 332OW, shower holder water punch on flange, all in brass and flexible hose cm 120.



I60W

Miscelatore incasso shut-off serie Infinity comprensivo di: doccetta shut-off 332OW, supporto doccia-presa acqua su piastra in ottone e flessibile cm 120.
Built-in shower mixer set Infinity series including: shut-off 332OW, shower holder water punch on flange, all in brass and flexible hose cm 120.

**S603**

Miscelatore incasso shut-off serie SQ3 comprensivo di: doccetta shut-off 332OS, supporto doccia presa acqua su piastra in ottone e flessibile cm 120.

Built-in shut-off mixer set SQ3 series including: shut-off 332OS, shower holder water punch on flange, all in brass and flexible hose cm 120.

**Z60**

Miscelatore incasso shut-off serie Flash comprensivo di: doccetta shut-off 332OS, supporto doccia presa acqua su piastra in ottone e flessibile cm 120.

Built-in shut-off mixer set Flash series including: shut-off 332OS, shower holder water punch on flange, all in brass and flexible hose cm 120.

**Q60**

Miscelatore incasso shut-off serie Qubika comprensivo di: doccetta shut-off 332OS, supporto doccia presa acqua su piastra in ottone e flessibile cm 120.

Built-in shut-off mixer set Qubika series including: shut-off 332OS, shower holder water punch on flange, all in brass and flexible hose cm 120.

**W65**

Miscelatore incasso per shut-off serie Winner comprensivo di doccetta shut-off 332OL, supporto doccia-presa acqua, attacco conico da 1/2" e supporto shut-off, tutto in ottone, flessibile cm 120.

Built-in shower mixer set Winner series including: shut-off 332OL, shower holder water punch on flange, all in brass, with 1/2 connection, handshower support and flexible hose cm 120.

**W65W**

Miscelatore incasso per shut-off serie Winner comprensivo di doccetta shut-off 332OW, supporto doccia-presa acqua, attacco conico da 1/2" e supporto shut-off, tutto in ottone, flessibile cm 120.

Built-in shower mixer set Winner series including: shut-off 332OW, shower holder water punch on flange, all in brass, with 1/2 connection, handshower support and flexible hose cm 120.

**W65B**

Miscelatore incasso per shut-off serie Winner su piastra in ottone, attacco conico da 1/2" e supporto shut-off.

Built-in shut-off mixer Winner series all in brass with 1/2 connection and handshower support.

**I65**

Miscelatore incasso shut-off serie Infinity comprensivo di doccetta shut-off 332OL, supporto doccia-presa acqua, attacco conico da 1/2" e supporto shut-off, tutto in ottone, flessibile cm 120.

Built-in shower mixer set Infinity series including: shut-off 332OL, shower holder water punch on flange, all in brass, with 1/2 connection, handshower support and flexible hose cm 120.

**I65W**

Miscelatore incasso shut-off serie Infinity comprensivo di doccetta shut-off 332OW, supporto doccia-presa acqua, attacco conico da 1/2" e supporto shut-off, tutto in ottone, flessibile cm 120.

Built-in shower mixer set Infinity series including: shut-off 332OW, shower holder water punch on flange, all in brass, with 1/2 connection, handshower support and flexible hose cm 120.

**I65B**

Miscelatore incasso per shut-off serie Infinity su piastra in ottone, attacco conico da 1/2" e supporto shut-off.

Built-in shut-off mixer Infinity series all in brass with 1/2 connection and handshower support.

**L65**

Miscelatore incasso shut-off serie Class Line comprensivo di doccetta shut-off 332OL, supporto doccia-presa acqua, attacco conico da 1/2" e supporto shut-off, tutto in ottone, flessibile cm 120.

Built-in shower mixer set Class Line series including: shut-off 332OL, shower holder water punch on flange, all in brass, with 1/2 connection, handshower support and flexible hose cm 120.

**L65W**

Miscelatore incasso shut-off serie Class Line comprensivo di doccetta shut-off 332OW, supporto doccia-presa acqua, attacco conico da 1/2" e supporto shut-off, tutto in ottone, flessibile cm 120.

Built-in shower mixer set Class Line series including: shut-off 332OW, shower holder water punch on flange, all in brass, with 1/2 connection, handshower support and flexible hose cm 120.

**L65B**

Miscelatore incasso per shut-off serie Class Line su piastra in ottone, attacco conico da 1/2" e supporto shut-off.

Built-in shut-off mixer Class Line series all in brass with 1/2 connection and handshower support.

BOX INCASSO
BUILT-IN BOXKIT WELLNESS
WELLNESS KITCROMOTERAPIA
COLOR THERAPYSOFFIONI
SHOWER HEADSBOCCHE
SPOUTSPANNELLI DOCCIA
SHOWER PANELSCOLONNE DOCCIA
SHOWER COLUMNSSALISCENDI
SLIDING RAILSDOCCETTE
HAND SHOWERS

SHUT-OFF

BORDO VASCA
DECK BATH MIXERFLESSIBILI DOCCIA
SHOWER FLEXIBLES

SHUT-OFF



D65

Miscelatore incasso shut-off serie Dream comprensivo di doccetta shut-off 332OL, supporto doccia-presa acqua, attacco conico da 1/2" e supporto shut-off, tutto in ottone, flessibile doccia cm 120.

Built-in shower mixer set Dream series including: shut-off 332OL, shower holder water punch on flange, all in brass, with 1/2 connection, handshower support and flexible hose cm 120.



D65W

Miscelatore incasso shut-off serie Dream comprensivo di doccetta shut-off 332OW, supporto doccia-presa acqua, attacco conico da 1/2" e supporto shut-off, tutto in ottone, flessibile cm 120.

Built-in shower mixer Dream series set including: shut-off 332OW, shower holder water punch on flange, all in brass, with 1/2 connection, handshower support and flexible hose cm 120.



D65B

Miscelatore incasso per shut-off serie Dream su piastra in ottone, attacco conico da 1/2" e supporto shut-off.

Built-in shut-off mixer Dream series all in brass with 1/2 connection and handshower support.



N65

Miscelatore incasso shut-off serie Minimal comprensivo di doccetta shut-off 332OL, supporto doccia-presa acqua, attacco conico da 1/2" e supporto shut-off, tutto in ottone, flessibile cm 120.

Built-in shower mixer set Minimal series including shut-off 332OL, shower holder water punch on flange, all in brass, with 1/2 connection, handshower support and flexible hose cm 120.



N65W

Miscelatore incasso shut-off serie Minimal comprensivo di doccetta shut-off 332OW, supporto doccia-presa acqua, attacco conico da 1/2" e supporto shut-off, tutto in ottone, flessibile doccia cm 120.

Built-in shower mixer set Minimal series including: shut-off 332OW, shower holder water punch on flange, all in brass, with 1/2 connection, handshower support and flexible hose cm 120.



N65SW

Miscelatore incasso shut-off serie Minimal con leva corta, comprensivo di doccetta shut-off 332OW, supporto doccia-presa acqua, attacco conico da 1/2" e supporto shut-off, tutto in ottone, flessibile cm 120.

Built-in shower mixer Minimal series set with short lever, including: shut-off 332OW, shower holder water punch on flange, all in brass, with 1/2 connection, handshower support and flexible hose cm 120.



N65B

Miscelatore incasso per shut-off serie Minimal su piastra in ottone, attacco conico da 1/2" e supporto shut-off.

Built-in shut-off mixer Minimal series all in brass with 1/2 connection and handshower support.



V65W

Miscelatore incasso shut-off serie Vanity comprensivo di doccetta shut-off 332OW, supporto doccia-presa acqua, attacco conico da 1/2" e supporto shut-off, tutto in ottone, flessibile cm 120.

Built-in shower mixer Vanity series set including: shut-off 332OW, shower holder water punch on flange, all in brass, with 1/2 connection, handshower support and flexible hose cm 120.



X65W

Miscelatore incasso shut-off serie X Style comprensivo di doccetta shut-off 332OW, supporto doccia-presa acqua, attacco conico da 1/2" e supporto shut-off, tutto in ottone, flessibile cm 120.

Built-in shower mixer X Style series set including: shut-off 332OW, shower holder water punch on flange, all in brass, with 1/2 connection, handshower support and flexible hose cm 120.



Q65

Miscelatore incasso shut-off serie Qubika comprensivo di doccetta shut-off 332OS, supporto doccia-presa acqua, attacco conico da 1/2" e supporto shut-off, tutto in ottone, flessibile cm 120.

Built-in shower mixer Qubika series set including: shut-off 332OS, shower holder water punch on flange, all in brass, with 1/2 connection, handshower support and flexible hose cm 120.



V65B

Miscelatore incasso per shut-off serie Vanity su piastra in ottone, attacco conico da 1/2" e supporto shut-off.

Built-in shut-off mixer Vanity series all in brass with 1/2 connection and handshower support.



X65B

Miscelatore incasso per shut-off serie X Style su piastra in ottone, attacco conico da 1/2" e supporto shut-off.

Built-in shut-off mixer X Style series all in brass with 1/2 connection and handshower support.



Q65B

Miscelatore incasso per shut-off serie Qubika su piastra in ottone, attacco conico da 1/2" e supporto shut-off.

Built-in shut-off mixer Qubika series all in brass with 1/2 connection and handshower support.

SHUT-OFF TERMOSTATICO THERMOSTATIC SHUT-OFF



NT60W

Miscelatore incasso per shut-off serie Minimal Thermo comprensivo di: doccetta shut-off 332OW, supporto doccia presa acqua su piastra in ottone e flessibile cm 120.

Built-in shut-off mixer set Minimal Thermo series including: shut-off 332OW, shower holder water punch on flange, all in brass and flexible hose cm 120.

MISCELATORI CON DEVIAZIONE INTEGRATA PER SHUT-OFF MIXERS WITH INTEGRATED DEVIATION FOR SHUT-OFF

NEW



L10SHW

Miscelatore monocomando lavabo serie Class Line con doccetta shut-off 332OW e scarico click-clack con troppo pieno.

Single-lever basin mixer Class Line series with handshower shut-off 332OW, and click-clack waste with overflow.



W10SHW

Miscelatore monocomando lavabo serie Winner con doccetta shut-off 332OW e scarico click-clack con troppo pieno.

Single-lever basin mixer Winner series with handshower shut-off 332OW, and click-clack waste with overflow.

MISCELATORI SHUT-OFF CONN INTERASSE 100MM SHUT-OFF MIXERS WITH INTERAXIS 100MM



Miscelatore monocomando esterno doccia serie Class Line, interasse 100 mm.

Wall mounted single lever shower mixer Class Line series, interaxis 100 mm

LC31

senza kit doccia.
without dhower set.

LC31DP

con kit composto da doccetta shut-off in ABS cromato 332DPCR, flessibile conico in ottone 120 cm e gancio cromato 332GA.

with kit including: shut-off handshower in c.p. ABS 332DPCR, conical flexible hose in brass cm 120 and c.p. hook 332GA.



Miscelatore monocomando esterno doccia serie Infinity, interasse 100 mm.

Wall mounted single lever shower mixer Infinity series, interaxis 100 mm

IC31

senza kit doccia.
without dhower set.

IC31REW

con kit composto da doccia a pulsante 332OW, flessibile conico 120 cm e supporto 339SO in ottone.

with kit including: shut-off handshower 332OW, conical flexible hose cm 120 and shower holder 339SO.



Miscelatore monocomando esterno doccia serie Winner, interasse 100 mm.

Wall mounted single lever shower mixer Winner series, interaxis 100 mm

WC31

senza kit doccia.
without dhower set.

WC31DP

con kit composto da doccetta shut-off in ABS cromato 332DPCR, flessibile conico in ottone 120 cm e gancio cromato 332GA.

with kit composed of shut-off handshower in c.p. ABS 332DPCR, conical flexible hose in brass cm 120 and c.p. hook 332GA.



C332REL

Set "Relax" composto da: doccia a pulsante 332OL, flessibile conico 120 cm, miscelatore doccia serie Cento C33 interasse 100 mm e supporto "lux" in ottone.

"Relax" set including: shut-off handshower 332OL, conical flexible hose cm 120, shower mixer serie Cento C33 interaxis 100 mm and brass "Lux" shower holder.



C332REZ

Set "Relax" composto da: doccia a pulsante 332OZ, flessibile conico 120 cm, miscelatore doccia serie Cento C33 interasse 100 mm e supporto "lux" in ottone.

"Relax" set including: shut-off handshower 332OZ, conical flexible hose cm 120, shower mixer serie Cento C33 interaxis 100 mm and brass "Lux" shower holder.



C332RELA

Set "Relax" composto da: doccia a pulsante 332OLA, flessibile conico 120 cm, miscelatore doccia serie Cento C33 interasse 100 mm e supporto "lux" in ottone.

"Relax" set including: shut-off handshower 332OLA, conical flexible hose cm 120, shower mixer serie Cento C33 interaxis 100 mm and brass "Lux" shower holder.



C332DP

Esterno doccia con leva frontale, interasse 100 mm, doccetta shut-off in ABS cromato e flessibile da 120 cm. Wall mounted single-lever shower mixer, interaxis 100 mm, with frontal lever, with handshower shut-off in c.p. ABS and flexible hose 120 cm.

BOX INCASSO
BUILT-IN BOXKIT WELLNESS
WELLNESS KITCROMOTERAPIA
COLOR THERAPYSOFFIONI
SHOWER HEADSBOCCHE
SPOUTSPANNELLI DOCCIA
SHOWER PANELSCOLONNE DOCCIA
SHOWER COLUMNSSALISCENDI
SLIDING RAILSDOCCETTE
HAND SHOWER

SHUT-OFF

BORDO VASCA
DECK BATH MIXERFLESSIBILI DOCCIA
SHOWER FLEXIBLES

SHUT-OFF



C312DP

Esterno doccia, interasse 100 mm, doccetta shut-off in ABS cromato e flessibile da 120 cm.
Wall mounted single-lever shower mixer interaxis 100 mm, with handshower shut-off in c.p. ABS and flexible hose 120 cm.

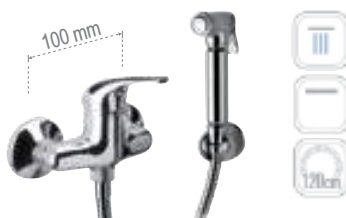

C312REL

Esterno doccia, interasse 100 mm, doccetta shut-off in ottone e flessibile da 120 cm.
Wall mounted single-lever shower mixer interaxis 100 mm, with handshower shut-off in brass and flexible hose 120 cm.



C312RELA

Esterno doccia, interasse 100 mm, doccetta shut-off in ottone e flessibile da 120 cm.
Wall mounted single-lever shower mixer interaxis 100 mm, with handshower shut-off in brass and flexible hose 120 cm.

SHUT-OFF MONOACQUA - SINGLE WATER SHUT-OFF



332REL336

Set composto da: doccia a pulsante 332OL, flessibile con attacco conico cm 120, rubinetto d'arresto con supporto doccia in ottone.
Set including: shut-off handshower 332OL, flexible hose cm 120, brass round angle valve with shower holder.



332RES336

Set composto da: doccia a pulsante quadrata 332OS, flessibile con attacco conico cm 120, rubinetto d'arresto con supporto doccia in ottone.
Set including: shut-off handshower 332OS, flexible hose cm 120, brass squared angle valve with shower holder.



332REW336

Set quadrato composto da: doccia a pulsante 332OW, flessibile con attacco conico cm 120, rubinetto d'arresto con supporto doccia in ottone.
Squared set including: shut-off handshower 332OW, flexible hose cm 120, brass round angle valve with shower holder.



332RELA336

Set composto da: doccia a pulsante 332OLA (compreso di aeratore e chiave 83AC), flessibile con attacco conico cm 120, rubinetto d'arresto con supporto doccia in ottone.
Set including: shut-off handshower 332OLA (complete of aerator and key kit 83AC), flexible hose cm 120, brass squared angle valve with shower holder.

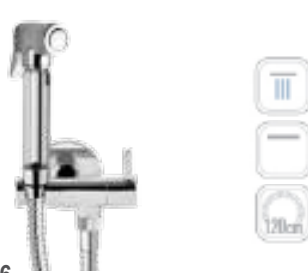

332REZ336

Set composto da: doccia a pulsante con impugnatura zigrinata 1/2" 332OZ, flessibile con attacco conico cm 120, rubinetto d'arresto, con supporto doccia in ottone.
Set including: shut-off handshower with knurled handgrip 1/2" 332OZ, flexible hose cm 120, brass round angle valve with shower holder.



332REU336

Set composto da: doccia a pulsante minimale in ABS cromata 332EU, flessibile con attacco conico cm 120, rubinetto d'arresto, con supporto doccia in ottone.
Set including: shut-off ABS minimal handshower 332EU, flexible hose cm 120, brass squared angle valve with shower holder.

**338M332OL**

Set composto da: doccetta a pulsante, flessibile con attacco conico cm 120, rubinetto ad angolo Minimal con vitone ceramico e supporto doccia "Lux" in ottone.
Set composed of: shut-off handshower, cm 120 flexible hose with one conical nut, angle valve serie "Minimal" with ceramic headwork and "Lux" brass shower holder.

**338M332OW**

Set composto da: doccetta a pulsante, flessibile con attacco conico cm 120, rubinetto ad angolo Minimal con vitone ceramico e supporto doccia "Lux" in ottone.
Set composed of: shut-off handshower, cm 120 flexible hose with one conical nut, angle valve serie "Minimal" with ceramic headwork and "Lux" brass shower holder.

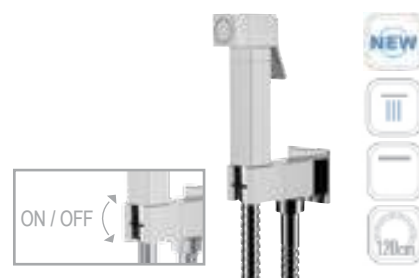
**338Q332OS**

Set composto da: doccetta a pulsante, flessibile con attacco conico cm 120, rubinetto ad angolo SQ con vitone ceramico e supporto doccia "Lux" in ottone.
Set composed of: shut-off handshower, cm 120 flexible hose with one conical nut, angle valve serie "SQ" with ceramic headwork and "Lux" brass shower holder.

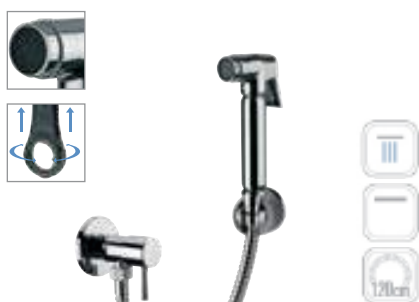

Set "Relax", composto da: doccia a pulsante 332OLA (compresa di aeratore e chiave 83AC), flessibile conico 120 cm, supporto "Lux" in ottone.

"Relax" set including: shut-off handshower 332OLS (complete of aerator and key kit 83AC), conical flexible hose 120 cm, "Lux" brass shower holder.

332332OLA

senza rubinetto sottolavabo.
without angle valve.

332RELA

con rubinetto sottolavabo "Minimal" e vitone ceramico.
with "Minimal" angle valve and ceramic headwork.



Set "Relax", composto da: doccia a pulsante 332OZ, flessibile conico 120 cm, supporto "Lux" in ottone.

"Relax" set including: shut-off handshower 332OZ, conical flexible hose cm, "Lux" brass shower holder.

332332OZ

senza rubinetto sottolavabo.
without angle valve.

332REZ

con rubinetto sottolavabo "Minimal" e vitone ceramico.
with "Minimal" angle valve and ceramic headwork.



Set "Relax SQ" composto da: doccia quadrata a pulsante 332OS, flessibile conico 120 cm, supporto "Lux" in ottone.

"Relax SQ" set, including: "SQ" shut-off handshower 332OS, conical flexible hose 120 cm, "Lux" brass shower holder.

332332OS

senza rubinetto sottolavabo.
without angle valve.

332RES

con rubinetto sottolavabo "SQ" con vitone ceramico.
with "SQ" angle valve with ceramic headwork.



Set "Eurolux" composto da: doccia a pulsante minimale in ABS cromata 332EU, flessibile conico metallizzato 120 cm, supporto in ABS.

"Eurolux" set including: shut-off handshower minimal in c.p. ABS 332EU, conical metallized flexible hose cm 120, ABS shower holder.

332332EUM

senza rubinetto sottolavabo.
without angle valve.

332EUM

con rubinetto sottolavabo Minimal con vitone ceramico.
with Minimal angle valve with ceramic headvalve.



Set "Relax", composto da: doccia a pulsante 332OL, flessibile conico 120 cm, supporto "Lux" in ottone.

"Relax" set including: shut-off handshower 332OL, conical flexible hose 120 cm, "Lux" brass shower holder.

332332OL

senza rubinetto sottolavabo.
without angle valve.

332REL

con rubinetto sottolavabo Minimal con vitone ceramico.
with Minimal angle valve with ceramic headvalve.

**332REL129**

Set "Relax" composto da: doccia a pulsante 332OL, flessibile conico 120 cm, rubinetto sottolavabo art. 129 e supporto "Lux" in ottone.

"Relax" set including: shut-off handshower 332OL, conical flexible hose 120 cm, angle valve art. 129 and "Lux" brass shower holder.

**332REZ129**

Set "Relax" composto da: doccia a pulsante 332OZ, flessibile conico 120 cm, rubinetto sottolavabo art. 129 e supporto "Lux" in ottone.

"Relax" set including: shut-off handshower 332OZ, conical flexible hose 120 cm, angle valve art. 129 and "Lux" brass shower holder.

BOX INCASSO
BUILT-IN BOXKIT WELLNESS
WELLNESS KITCROMOTERAPIA
COLOR THERAPYSOFFIONI
SHOWER HEADSBOCCHE
SPOUTSPANNELLI DOCCIA
SHOWER PANELSCOLONNE DOCCIA
SHOWER COLUMNSSALISCENDI
SLIDING RAILSDOCCETTE
HAND SHOWERS

SHUT-OFF

BORDO VASCA
DECK BATH MIXERFLESSIBILI DOCCIA
SHOWER FLEXIBLES

SHUT-OFF



Set "Relax", composto da: doccia a pulsante 332OW, flessibile conico 120 cm, supporto "Lux" in ottone.
"Relax" set including: shut-off handshower 332OW, conical flexible hose 120 cm, "Lux" brass shower holder.

332332OW

senza rubinetto sottolavabo.
without angle valve.

332REW

con rubinetto sottolavabo Minimal in ottone con vitone ceramico.
with angle valve in brass serie Minimal and with ceramic headwork.



332TEL

Set composto da: doccia a pulsante, flessibile conico 120 cm, rubinetto temporizzato 1/2" in ottone tempo di apertura 6-8 secondi.
Set including: shut-off handshower, flexible cm 120, temporized button flusher 1/2" all in Brass, opening time 6-8 seconds.



332RGRR

Set composto da flessibile retinato bianco cm 120, rompigitto con gancio, appendino, rubinetto sottolavabo.
Set including: shower flexible in white net working cm 120, jet breaker with holder, hook, angle valve.



Set composto da: doccia a pulsante bianca 332 OR, flessibile retinato 120 cm e supporto bianco 339 F BI.
Set including: white plastic shut-off handshower 332 OR, net worked flexible hose cm 120 and white shower support 339 F BI.

332332OR

senza rubinetto sottolavabo.
without angle valve.

332RER

con rubinetto sottolavabo in ottone.
with angle valve in brass.



doccia a pulsante cromata 332ORCR, flessibile conico 120 cm e supporto cromato 339 F.
chrome plastic shut-off handshower 332ORCR, conical flexible hose cm 120, and chrome shower support 339 F.

332332ORCR

senza rubinetto sottolavabo.
without angle valve.

332RERCR

con rubinetto sottolavabo in ottone.
with angle valve in brass.



Set "Eco" composto da: doccia a pulsante bianca 332DPR, flessibile retinato 120 cm e gancio bianco 332GA.
"Eco" set including: white plastic shut-off handshower 332DPR, net worked flexible hose cm 120 and white hook 332GA.

33212

senza rubinetto sottolavabo.
without angle valve.

332DPRR

con rubinetto sottolavabo in ottone.
with angle valve in brass.

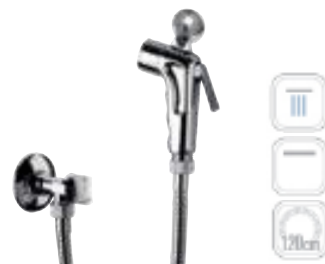

Set "Eco" composto da: doccia a pulsante cromata 332DPCR, flessibile cromato 120 cm e gancio cromato 332GA.
"Eco" set including: c.p. plastic shut-off handshower 332DPCR, conical brass flexible hose cm 120 and c.p. hook 332GA.

332332DCR

senza rubinetto sottolavabo.
without angle valve.

332DCR

con rubinetto sottolavabo in ottone.
with angle valve in brass.



332RGRE120

Set composto da flessibile retinato bianco cm 120, rompigitto con gancio, appendino.
Set including: white shower flexible hose net working cm 120, jet breaker with shower holder, hook.



332RG

Rompigitto in ABS cromato con anello per attacco a muro.
C.p. ABS flow regulator with ring for wall connection.



81RD12

Riduzione 1/2MxM22 di collegamento flessibile doccia con aeratore F22 (nostro art. 81).
Reduction 1/2MxM22 to connect the shower flexible to F22 aerator (our article 81).



332GA

Appendino in ABS cromato.
C.p. ABS hook.



332GABI

Appendino in ABS bianco.
White ABS hook.



81

Aeratore classico con retine in inox, per gruppo lavello F22.
Classic aerator with inox nets, for sink spout F22.

DOCCETTE SHUT-OFF IN OTTONE - SHUT-OFF HANDSHOWER IN BRASS

**3320S**

Doccetta a pulsante quadrata, in ottone, 1/2".
Brass squared shut-off, with plain handgrip, 1/2"

SENZA SCATOLA WITHOUT BOX	CON SCATOLA WITH BOX
3320S	3320SX

**3320L**

Doccetta a pulsante "Lux" in ottone, con impugnatura liscia 1/2".
Brass shut-off "Lux" handshower with plain handgrip, 1/2".

SENZA SCATOLA WITHOUT BOX	CON SCATOLA WITH BOX
3320L	3320LX

**3320Z**

Doccetta a pulsante "Lux" in ottone, con impugnatura zigrinata 1/2".
Brass shut-off "Lux" handshower with knurled handgrip, 1/2".

SENZA SCATOLA WITHOUT BOX	CON SCATOLA WITH BOX
3320Z	3320ZX

BOX INCASSO
BUILT-IN BOXKIT WELLNESS
WELLNESS KITCROMOTERAPIA
COLOR THERAPYSOFFIONI
SHOWER HEADSBOCCHE
SPOUTSPANNELLI DOCCIA
SHOWER PANELSCOLONNE DOCCIA
SHOWER COLUMNSSALISCENDI
SLIDING RAILSDOCCETTE
HAND SHOWERS

SHUT-OFF

BORDO VASCA
DECK BATH MIXERFLESSIBILI DOCCIA
SHOWER FLEXIBLES**3320B**

Doccetta a pulsante "Lux" in ottone, con impugnatura bombata 1/2".
Brass shut-off "Lux" handshower with convex handgrip, 1/2".

SENZA SCATOLA WITHOUT BOX	CON SCATOLA WITH BOX
3320B	3320BX

**3320LA**

Doccetta a pulsante "Lux" in ottone, con impugnatura liscia da 1/2" completa di kit aeratore con chiave 83AC, nuovo sistema brevettato ad alta tecnologia per la pulizia dell'aeratore e di lunghissima durata.
Brass shut-off "Lux" handshower, with plain handgrip, 1/2" complete with aerator and key kit 83AC, new Patented system of high technology for the cleaning of the aerator, extremely long lasting.

SENZA SCATOLA WITHOUT BOX	CON SCATOLA WITH BOX
3320LA	3320LAX

**3320W**

Doccetta a pulsante "Lux" minimale in ottone, con impugnatura liscia 1/2".
Minimal Brass shut-off "Lux" handshower with plain handgrip, 1/2".

SENZA SCATOLA WITHOUT BOX	CON SCATOLA WITH BOX
3320W	3320WX

DOCCETTE SHUT-OFF IN ABS - SHUT-OFF HANDSHOWER IN ABS

**332EU**

Doccetta a pulsante minimale in ABS cromata con impugnatura liscia, 1/2".
C.p. ABS minimal shut-off, with plain handgrip, 1/2".

SENZA SCATOLA WITHOUT BOX	CON SCATOLA WITH BOX
332EU	332EUX

**332DPCR**

Doccetta a pulsante, 1/2 cromata.
C.P. shut-off, 1/2.

**332DPBN**

Doccetta a pulsante, 1/2 bianca.
White shut-off, 1/2.

**332LUCR**

Doccetta a pulsante, 1/2 cromata.
C.P. shut-off, 1/2

**332OR**

Doccetta shut-off bianca in ABS stampata made in italy.
White ABS shut off handshower printed made in italy.

**332ORCR**

Doccetta shut-off cromata in ABS stampata made in italy.
Chrome ABS shut off handshower printed made in italy.

**332ORNE**

Doccetta shut-off nera in ABS stampata made in italy.
Black ABS shut off handshower printed made in italy.

BORDO VASCA - DECK BATH MIXER

BORDO VASCA DECK BATH MIXER





BOX INCASSO
BUILT-IN BOX

KIT WELLNESS
WELLNESS KIT

CROMOTERAPIA
COLOR THERAPY

SOFFIONI
SHOWER HEADS

BOCCHE
SPOUTS

PANNELLI DOCCIA
SHOWER PANELS

COLONNE DOCCIA
SHOWER COLUMNS

SALISCENDI
SLIDING RAILS

DOCCETTE
HAND SHOWERS

SHUT-OFF

BORDO VASCA
DECK BATH MIXER

FLESSIBILI DOCCIA
SHOWER FLEXIBLES

DESIGN & EASY CONTEMPORARY



Z07
 Miscelatore monocomando bordo vasca serie Flash con bocca quadra, deviatore integrato nella bocca e doccetta quadrata estraibile ad 1 funzione in ottone, flessibile in ottone 150 cm.
Single-lever deck bath mixer Flash series, with squared spout, diverter integrated on the spout, 1 function squared brass pull-out handshower, brass flexible hose 150 cm.

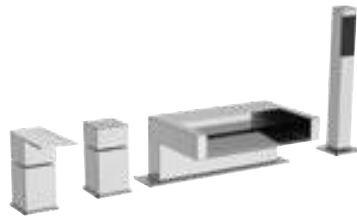

ZC06
 Miscelatore monocomando bordo vasca con deviatore, doccetta ad 1 funzione in ottone e bocca a cascata, flessibile in ottone 150 cm.
Single-lever deck bath mixer with diverter, 1 function squared brass pull-out handshower and waterfall spout, brass flexible hose 150 cm.

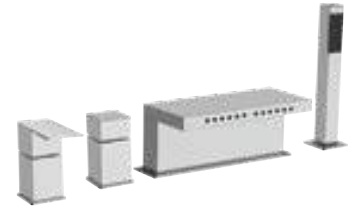

Z06
 Miscelatore monocomando bordo vasca con deviatore, doccetta ad 1 funzione in ottone e bocca multigetto, flessibile in ottone 150 cm.
Single-lever deck bath mixer with diverter, 1 function squared brass pull-out handshower and multijet spout, brass flexible hose 150 cm.



106



I07
 Miscelatore monocomando bordo vasca con deviatore integrato nella bocca e doccetta estraibile in ABS ad 1 funzione anticalcare, flessibile in ottone 150 cm.
Single lever deck bath mixer with lever diverter integrated on the spout, with minimal spout and 1 function ABS antilimestone pull-out handshower, brass flexible hose 150 cm.



I07UF
 Miscelatore monocomando bordo vasca con deviatore integrato nel miscelatore, bocca a cascata e doccetta estraibile in ABS ad 1 funzione anticalcare, flessibile in ottone 150 cm.
Single lever deck bath mixer with diverter integrated on the mixer, with waterfall spout and 1 function ABS antilimestone pull-out handshower, brass flexible hose 150 cm.



I06
 Miscelatore monocomando bordo vasca con deviatore, bocca con effetto multigetto e doccetta estraibile in ABS ad 1 funzione anticalcare, flessibile in ottone 150 cm.
Single lever deck bath mixer with diverter, spout with multijets effect and 1 function ABS antilimestone pull-out handshower, brass flexible hose 150 cm.



BOX INCASSO
BUILT-IN BOXKIT WELLNESS
WELLNESS KITCROMOTERAPIA
COLOR THERAPYSOFFIONI
SHOWER HEADSBOCCHE
SPOUTSPANNELLI DOCCIA
SHOWER PANELSCOLONNE DOCCIA
SHOWER COLUMNSSALISCENDI
SLIDING RAILSDOCCETTE
HAND SHOWERS

SHUT-OFF

BORDO VASCA
DECK BATH MIXERFLESSIBILI DOCCIA
SHOWER FLEXIBLES**N06317MM**

Miscelatore monocomando bordo vasca con deviatore, bocca con effetto multigetto e doccetta estraibile in ottone ad 1 funzione, flessibile in ottone 150 cm.

Single lever deck bath mixer with diverter, spout with multijets effect 1 function pull-out brass handshower, brass flexible hose 150 cm.

**N07**

Miscelatore monocomando bordo vasca con deviatore integrato nella bocca e doccetta estraibile ad 1 funzione in ottone, flessibile in ottone 150 cm.

Single lever deck bath mixer with lever diverter integrated in the spout, 1 function pull-out brass handshower, brass flexible hose 150 cm.

**CONTRACT****T07UF**

Miscelatore monocomando bordo vasca con deviatore integrato nel miscelatore, bocca pesante fusa con effetto a cascata e doccetta estraibile in ABS anticalcare a 4 funzioni, flessibile ottone 150 cm.

Single lever deck bath mixer with diverter integrated on the mixer, with heavy casted spout waterfall jet, antilimestone pull-out ABS handshower 4 functions, brass flexible hose 150 cm.

**T07**

Miscelatore monocomando bordo vasca con deviatore integrato nella bocca, bocca pesante fusa e doccetta estraibile in ABS anticalcare a 4 funzioni, flessibile in ottone 150 cm.

Single lever deck bath mixer with diverter integrated on the spout, heavy casted spout, antilimestone pull-out ABS handshower 4 functions, brass flexible hose 150 cm.



FLESSIBILI DOCCIA - SHOWER FLEXIBLES

FLESSIBILI DOCCIA SHOWER FLEXIBLE HOSES





BOX INCASSO
BUILT-IN BOX

KIT WELLNESS
WELLNESS KIT

CROMOTERAPIA
COLOR THERAPY

SOFFIONI
SHOWER HEADS

BOCCHIE
SPOUTS

PANNELLI DOCCIA
SHOWER PANELS

COLONNE DOCCIA
SHOWER COLUMNS

SALISCENDI
SLIDING RAILS

DOCCETTE
HAND SHOWERS

SHUT-OFF

BORDO VASCA
DECK BATH MIXER

FLESSIBILI DOCCIA
SHOWER FLEXIBLES

FLESSIBILI PER DOCCIA - FLEXIBLE HOSES FOR SHOWER



332CNBC

Flessibile doccia in PVC atossico con piattina cromata, attacco conico.

Flexible hose for shower in atoxic PVC and chrome flat wire inside all around, with one conical nut.

cm 120	cm 150	cm 200



332CNMTR

Flessibile per doccia retinato metallizzato in PVC atossico, con attacco conico.

Flexible hose for shower with net working metal colour, in atoxic PVC, with one conical nut.

cm 120	cm 150	cm 200



332CN2G

Flessibile per doccia retinato metallizzato in pvc atossico, con attacco doppio brillante conico.

Flexible hose for shower with net working metal colour, in atoxic pvc, with double conical shiny brilliant nut.

cm 120	cm 150	cm 200



332CNMT

Flessibile per doccia in pvc atossico grigio metallizzato, con attacco conico.

Flexible hose for shower, in metallized pvc, with one conical nut.

cm 120	cm 150	cm 200



332CN

Flessibile "Biflex" per doccia in pvc atossico, con attacco conico, in cromo bianco.

"Biflex" flexible hose in atoxic pvc for shower, with one conical nut, in chrome white.

cm 120	cm 150	cm 200



332

Flessibile "Biflex" per doccia in pvc atossico, con attacco a doppia ghiera.

"Biflex" flexible hose in atoxic pvc for shower, with double nut connection, in chrome white.

cm 120	cm 150	cm 200



332CNNC

Flessibile "Biflex" per doccia in pvc atossico, con attacco conico, in cromo nero.

"Biflex" flexible hose in atoxic pvc for shower, with one conical nut, in chrome black.

cm 120	cm 150	cm 200



332CNREBI

Flessibile per doccia retinato in pvc atossico, con attacco conico, retinatura bianca.

Flexible hose for shower with net working, in atoxic pvc, with one conical nut, white colour.

cm 120	cm 150	cm 200



334CNNC

Flessibile per doccia Spyroflex nero-cromo in pvc atossico, con un attacco conico.

Flexible hose for shower Spyroflex, black and chrome, in atoxic pvc, with one conical nut.

cm 120	cm 150	cm 200



334CNBC

Flessibile doccia Spyroflex, bianco-cromo, in pvc atossico, con un attacco conico.

Flexible hose for shower Spyroflex, in atoxic pvc, white-chrome, with one conical nut.

cm 120	cm 150	cm 200

FLESSIBILI PER DOGGIA ESTRAIBILE - FLEXIBLE HOSES FOR PULL-OUT

**332NY1512**

Flessibile doccia per estraibile cucina, con interno in gomma epdm alimentare, tracciato in nylon nero, con attacco conico + maschio girevole 15x1.

Flexible shower hose for sinks pull-outs with inside tube in epdm, braided with black nylon, with one conical nut and one swivelling male 15x1.

cm 120	cm 150	cm 200

**332NG1512**

Flessibile doccia per estraibile cucina, con interno in gomma epdm alimentare, tracciato in nylon grigio, con attacco conico + maschio girevole 15x1.

Flexible shower hose for sinks pull-outs with inside tube in epdm, braided with grey nylon, with one conical nut and one swivelling male 15x1.

cm 120	cm 150	cm 200

**332MT1512**

Flessibile doccia per estraibile cucina, in pvc atossico metallizzato, con attacco conico + maschio girevole 15x1.

Flexible shower hose for sinks pull-outs, in atoxic metallized pvc, with one conical nut and one swivelling male 15x1.

cm 120	cm 150	cm 200

**332IN1512**

Flessibile doccia per estraibile cucina, tracciato in acciaio inox, con interno in gomma epdm alimentare, con attacco conico + maschio girevole 15x1.

Flexible shower hose for sinks pull-outs with inside tube in epdm, braided with stainless steel, with one conical nut and one swivelling male 15x1.

cm 120	cm 150	cm 200

**332BX1512**

Flessibile doccia per estraibile cucina, con interno in gomma epdm alimentare, trecciato in nylon bianco e acciaio inox, con attacco conico + maschio girevole 15x1.

Flexible shower hose for sinks pull outs with inside tube in epdm, braided with white nylon and stainless steel, with one conical nut and one swivelling male 15x1.

cm 120	cm 150	cm 200

FLESSIBILI IN METALLO - FLEXIBLE METAL HOSES

**333**

Flessibile per doccia in ottone con attacco a doppia ghiera, tubo in EPDM.

Flexible hose for shower, in brass with double nut connection, EPDM rubber inside.

cm 100	cm 120	cm 150	cm 200

**333CN**

Flessibile per doccia in ottone Ø 14 F.F., con attacco conico, tubo in EPDM.

Flexible hose for shower, in Brass, EPDM rubber inside, Ø 14, with one conical nut.

cm 120	cm 150	cm 200

**333CNX**

Flessibile per doccia estraibile in acciaio INOX Ø 14, tubo interno in gomma EPDM, attacco conico, 1/2".

cm 120	cm 150	cm 200

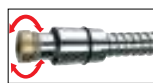

Girevole antitorsione
Anti-twist swivelling

**333CNDGAT**

Flessibile per doccia estensibile a doppia graffatura in ottone, con sistema girevole ed anti-torsione, Ø 15 mm, tubo in EPDM, con attacco conico.

Flexible and extensible hose for shower, in Brass, anti-twist swivelling system, Ø mm 15, EPDM rubber inside, with one conical nut.

cm 120	cm 150	cm 200

**333CNES**

Flessibile per doccia estensibile a doppia graffatura in ottone Ø 14 F.F., tubo in EPDM.

Flexible and extensible hose for shower, double clinching in Brass, Ø 14, EPDM rubber internal, with one conical nut.

cm 120	cm 150	cm 200

**333CNXES**

Flessibile per doccia estensibile a doppia graffatura in acciaio INOX Ø 14 F.F., tubo in EPDM, con attacco conico.

Flexible and extensible hose for shower, double clinching in stainless steel, Ø 14 F.F., EPDM rubber internal, with one conical nut.

cm 100	cm 120	cm 150	cm 175

BOX INCASSO
BUILT-IN BOXKIT WELLNESS
WELLNESS KITCROMOTERAPIA
COLOR THERAPYSOFFIONI
SHOWER HEADSBOCCHE
SPOUTSPANNELLI DOGGIA
SHOWER PANELSCOLONNE DOGGIA
SHOWER COLUMNSSALISCENDI
SLIDING RAILSDOCCETTE
HAND SHOWERS

SHUT-OFF

BORDO VASCA
DECK BATH MIXERFLESSIBILI DOGGIA
SHOWER FLEXIBLES

FLESSIBILI DOCCIA - SHOWER FLEXIBLES



333CN150UK - 333CN200UK

Flessibile per doccia a doppia graffatura in ottone Ø 17 F.F., tubo in EPDM, con attacco conico.

Flexible hose for shower, double clinching in Brass, 17 mm Ø F.F., EPDM rubber inside, with one conical nut.

cm 150	cm 200



333CN1512

Flessibile per doccia estraibile in ottone Ø 14, M15x1, 1/2" con attacco conico, tubo in EPDM.

Flexible in Brass for pull-out spray shower Ø 14, M15x1, 1/2" with one conical nut, EPDM rubber inside.

cm 120	cm 150

FLESSIBILI DOCCIA IN FINITURA - SHOWER FLEXIBLE HOSES WITH FINISHING



Flessibile per doccia estraibile in acciaio INOX Ø 14, tubo interno in gomma EPDM, attacco conico, 1/2", nero opaco.

Shower flexible hose in stainless steel Ø 14, internal in EPDM rubber, one conical nut, 1/2", matt black.

333CNX120NO - 120cm	
333CNX150NO - 150cm	



Flessibile per doccia retinato metallizzato in pvc atossico, con attacco doppio brillante conico, nero opaco.

Flexible hose for shower with net working metal colour, in atoxic pvc, with double conical shiny brilliant nut, matt black.

332CN2G120NO - 120cm	
332CN2G150NO - 150cm	



Flessibile per doccia retinato metallizzato in pvc atossico, con attacco doppio brillante conico, bianco opaco.

Flexible hose for shower with net working metal colour, in atoxic pvc, with double conical shiny brilliant nut, matt white.

332CN2G120BO - 120cm	
332CN2G150BO - 150cm	



Flessibile per doccia retinato metallizzato in pvc atossico, con attacco doppio brillante conico, oro lucido.

Flexible hose for shower with net working metal colour, in atoxic pvc, with double conical shiny brilliant nut, shiny gold.

332CN2G120DO - 120cm	
332CN2G150DO - 150cm	



Flessibile per doccia retinato metallizzato in pvc atossico, con attacco doppio brillante conico, oro spazzolato.

Flexible hose for shower with net working metal colour, in atoxic pvc, with double conical shiny brilliant nut, brush gold.

332CN2G120BG - 120cm	
332CN2G150BG - 150cm	



Flessibile per doccia retinato metallizzato in pvc atossico, con attacco doppio brillante conico, cromo nero spazzolato.

Flexible hose for shower with net working metal colour, in atoxic pvc, with double conical shiny brilliant nut, brushed black chrome.

332CN2G120CFP - 120cm	
332CN2G150CFP - 150cm	



Flessibile per doccia retinato metallizzato in pvc atossico, con attacco doppio brillante conico, nichel spazzolato.

Flexible hose for shower with net working metal colour, in atoxic pvc, with double conical shiny brilliant nut, brushed nickel.

332CN2G120NP - 120cm	
-----------------------------	--

332CN2G150NP - 150cm	
-----------------------------	--



Flessibile per doccia retinato metallizzato in pvc atossico, con attacco doppio brillante conico, nichel spazzolato opaco.

Flexible hose for shower with net working metal colour, in atoxic pvc, with double conical shiny brilliant nut, matt brushed nickel.

332CN2G120NPO - 120cm	
------------------------------	--

332CN2G150NPO - 150cm	
------------------------------	--



Flessibile per doccia retinato metallizzato in pvc atossico, con attacco doppio brillante conico, rame lucido.

Flexible hose for shower with net working metal colour, in atoxic pvc, with double conical shiny brilliant nut, shiny copper.

332CN2G120RL - 120cm	
-----------------------------	--

332CN2G150RL - 150cm	
-----------------------------	--



Flessibile per doccia retinato metallizzato in pvc atossico, con attacco doppio brillante conico, vecchio rame.

Flexible hose for shower with net working metal colour, in atoxic pvc, with double conical shiny brilliant nut, old copper.

332CN2G120VR - 120cm	
-----------------------------	--

332CN2G150VR - 150cm	
-----------------------------	--



Flessibile per doccia retinato metallizzato in pvc atossico, con attacco doppio brillante conico, vecchio ottone.

Flexible hose for shower with net working metal colour, in atoxic pvc, with double conical shiny brilliant nut, old brass.

332CN2G120VO - 120cm	
-----------------------------	--

332CN2G150VO - 150cm	
-----------------------------	--



332CN2G120NO

BOX INCASSO
BUILT-IN BOX

KIT WELLNESS
WELLNESS KIT

CROMOTERAPIA
COLOR THERAPY

SOFFIONI
SHOWER HEADS

BOCCHE
SPOUTS

PANNELLI DOCCIA
SHOWER PANELS

COLONNE DOCCIA
SHOWER COLUMNS

SALISCENDI
SLIDING RAILS

DOCCETTE
HAND SHOWERS

SHUT-OFF

BORDO VASCA
DECK BATH MIXER

FLESSIBILI DOCCIA
SHOWER FLEXIBLES



A modern kitchen featuring dark blue, vertically-grained cabinetry. A thick, natural wood island is positioned in the foreground, with three light-colored, upholstered bar stools tucked under it. In the background, a built-in wine cooler with glass doors is visible, showing several bottles. The kitchen counter is made of white marble, and a vase of white lilies sits on the island. The lighting is warm and focused on the island and wine cooler.

ARREDARE LA CUCINA
FURNISH THE KITCHEN

TECNOLOGIA IN CUCINA - *TECHNOLOGY IN THE KITCHEN*

ELEGANZA IN CUCINA - *ELEGANT KITCHEN*



TOUCH-ME

pag. 468



COLOR

pag. 472



ACQUA DEPURATA | *PURIFIED WATER*

pag. 474

TOUCH-ME

TOUCH-ME



La tecnologia TOUCH-ME integrata nei miscelatori per cucina di Remer Rubinetterie permette di azionare ed interrompere l'erogazione dell'acqua con un semplice tocco, aggiungendo ad ogni gesto quotidiano nuovi vantaggi in termini di igiene, praticità e sicurezza.

The TOUCH-ME technology integrated in Remer Rubinetterie kitchen mixers allows you to activate and stop the water supply with a simple touch, adding new advantages to every daily gesture in terms of hygiene, practicality and safety.



TOUCH-ME

COLOR

ACQUA DEPURATA
PURIFIED WATER

UN TOCCO HI-TECH NELLA TUA CUCINA

La tecnologia integrata TOUCH-ME consente di aprire e chiudere l'acqua del rubinetto della cucina con un semplice tocco. Un leggero contatto con il dorso della mano o l'avambraccio vi eviterà infatti di impugnare la leva di miscelazione quando avete le mani sporche o impegnate, ottimizzando i tempi delle operazioni e preservando la pulizia del prodotto.

La modalità interattiva TOUCH-ME aggiunge nuovi vantaggi ai miscelatori per cucina Remer Rubinetterie, eccone alcuni:

PRATICITÀ: completa le tue operazioni in cucina senza interruzioni e con la libertà di usare sempre entrambe le mani.

IGIENE: non sarà più necessario impugnare la leva con le mani sporche o bagnate. E nemmeno impugnare la leva dopo essersi igienizzati le mani sotto l'acqua.

VELOCITÀ: utilizza il rubinetto in modo pratico e tempestivo, ottimizzando i tempi di tutte le operazioni in cucina. **RISPARMIO IDRICO**: la velocità del sistema TOUCH-ME elimina lo spreco dell'acqua solitamente lasciata scorrere nell'attesa di pulirsi o liberarsi le mani.

SICUREZZA: la modalità TOUCH-ME prevede un sistema di sicurezza con chiusura automatica dell'acqua dopo 45 secondi. In questo modo sarà impossibile dimenticare il rubinetto aperto.

L'installazione dei miscelatori TOUCH-ME è semplice e discreta, occupa poco spazio sotto al lavello e non richiede collegamenti alla rete elettrica (funzionamento a batterie). Alimentazione con 4 batterie al litio AA (incluse). Facile installazione salva-spazio sotto il lavello. Manuale di installazione guidata all'interno del prodotto. Tecnologia sviluppata in collaborazione con l'azienda italiana S.T.S.R. (www.stsr.it).



IT72

Miscelatore monocomando lavello, monoforo 90° con canna alta ad "C" dotata di tecnologia Touch-Me con leva laterale e bocca girevole. Dotato di cartuccia Ø35.

Single-lever sink mixer 90°, high "C" spout equipped with Touch-Me system with side lever and swivel spout. Equipped with Ø35 cartridge.



LT72

Miscelatore monocomando lavello, monoforo 90° con canna alta a "C" dotata di tecnologia Touch-Me con leva laterale e bocca girevole. Dotato di cartuccia Ø35.

Single-lever sink mixer 90°, high "C" spout equipped with Touch-Me system with side lever and swivel spout. Equipped with Ø35 cartridge.

A HI-TECH TOUCH IN YOUR KITCHEN

TOUCH-ME technology allows you to open and close the kitchen tap water with a simple touch. A slight contact with the back of the hand or forearm will prevent you from gripping the mixing lever when your hands are dirty or busy, optimizing operation times and preserving the cleanliness of the product.

The TOUCH-ME interactive mode adds new advantages to Remer Rubinetterie kitchen mixers, here are some of them:

CONVENIENCE: complete your kitchen operations without interruptions and with the freedom to always use both hands.

HYGIENE: it will no longer be necessary to hold the lever with dirty or wet hands. Equally it will not be necessary to hold the lever after having sanitized your hands under water.

SPEED: use the tap in a practical and timely manner, optimizing the time of all operations in the kitchen.

WATER SAVING: the speed of the TOUCH-ME system eliminates the waste of water usually left to flow while waiting to clean or free your hands.

SAFETY: the TOUCH-ME mode provides a safety system with automatic water shut-off after 45 seconds. In this way it will be impossible to forget the tap open.

The installation of the TOUCH-ME mixers is simple and discreet, takes up little space under the sink and does not require connections to the mains (battery operation). Power supply with 4 x AA lithium batteries (included). Space-saving easy installation under the sink. Guided installation manual inside the package. Technology developed in collaboration with the Italian company S.T.S.R. (www.stsr.it).



QT42U

Miscelatore monocomando lavello, monoforo 90° con canna alta ad "U" dotata di tecnologia Touch-Me con leva laterale e bocca girevole. Dotato di cartuccia Ø35.

Single-lever sink mixer 90°, high "U" spout equipped with Touch-Me system with side lever and swivel spout. Equipped with Ø35 cartridge.



WT72

Miscelatore monocomando lavello, monoforo 90° con canna alta ad "C" dotata di tecnologia Touch-Me con leva laterale e bocca girevole. Dotato di cartuccia Ø35.

Single-lever sink mixer 90°, high "C" spout equipped with Touch-Me system with side lever and swivel spout. Equipped with Ø35 cartridge.

L'attivazione e la disattivazione del sistema TOUCH-ME avviene con un semplice tocco. Il contatto con il miscelatore deve avvenire tramite tocco pelle-miscelatore o tramite intercessione di oggetto conduttivo tenuto da una persona.

L'erogazione dell'acqua si interrompe automaticamente dopo un periodo di tempo prestabilito, limitando ulteriormente il contatto con il miscelatore e aumentando la sicurezza di utilizzo. Questa funzione permette un notevole risparmio idrico ed energetico, collocando il prodotto in una fascia GREEN.

Activation and deactivation of the TOUCH-ME system occurs with a simple touch. The contact with the mixer must occur through a direct touch skin-mixer or through a conductive object held by a person.

The water supply stops automatically after a while, further limiting the contact with the mixer and thus increasing the usage safety.

This function allows a considerable water and energy saving, placing the product in a GREEN range.



IT72

Funzioni incluse nei miscelatori TOUCH-ME:

- Funzione TOUCH-ME: per apertura e chiusura dell'acqua con un tocco del miscelatore.
- Disattiva funzione TOUCH-ME: La modalità TOUCH-ME può sempre essere disattivata, permettendo il funzionamento del miscelatore in sola modalità manuale.
- TOCCO PROLUNGATO: il sistema riconosce un tocco veloce da un tocco prolungato quando il miscelatore è in funzione. Lo stato "aperto" del rubinetto cambia in "chiuso" solo quando il tocco è veloce, ma non cambia quando il tocco è prolungato. Questo permette di orientare la canna girevole, senza interferire con l'apertura dell'acqua.
- Funzione AUTOCHIUSURA: interrompe automaticamente l'erogazione dell'acqua dopo un periodo di tempo preimpostato di 45 secondi.

Functions included in the TOUCH-ME mixers:

- TOUCH-ME function: for opening and closing the water with a touch of the mixer.
- Deactivate TOUCH-ME function: to use the mixer in traditional mode.
- LONG TOUCH: the system recognizes a quick touch from a long touch when the mixer is in operation. The "open" status of the tap changes to "closed" only when the touch is quick, but does not change when the touch is prolonged. This allows you to orient the swivel spout without interfering with the water flow status.
- SELF-CLOSING function: automatically stops the water supply after a preset period of 45 seconds.

TOUCH-ME

COLOR

ACQUA DEPURATA
PURIFIED WATER

COLOR

COLOR



COLOR è una selezione di rubinetti miscelatori per la cucina realizzata per arricchire gli interni con il valore rigenerante della luce e dei colori. Il colore entra nel quotidiano con grande naturalezza grazie alla tecnologia COLOR LED LIGHT, inserita all'interno dei miscelatori, che permette di alimentare la luce led tramite il flusso d'acqua in uscita. La serie è dotata di cartuccia da 35 mm. Non richiede collegamenti elettrici o batterie.

COLOR is a mixer faucets selection created to enrich the kitchen interiors with the regenerating value of light and colors. Color energy enters everyday life with great naturalness thanks to the COLOR LED LIGHT technology, inserted inside the mixers, that allows you to power the LED light through the outgoing water flow. The series is equipped with a 35 mm cartridge. It does NOT require electrical connections or batteries.

TOUCH-ME

COLOR

ACQUA DEPURATA
PURIFIED WATER

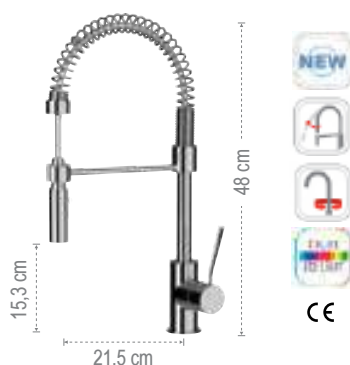

NR77E

Miscelatore monocomando lavello a molla con doccetta a led, estraibile dal supporto e orientabile. Doccetta disponibile in 4 varianti; A, B, C e D. Single-lever sink mixer with spring spout, and pull-out adjustable led colour handshower. Handshower available in 4 variants: A, B, C and D.



LR77E

Miscelatore monocomando lavello a molla con doccetta a led, estraibile dal supporto e orientabile. Doccetta disponibile in 4 varianti; A, B, C e D. Single-lever sink mixer with spring spout, and pull-out adjustable led colour handshower. Handshower available in 4 variants: A, B, C and D.



EYR77E

Miscelatore monocomando lavello a molla con doccetta a led, estraibile dal supporto e orientabile. Doccetta disponibile in 4 varianti; A, B, C e D. Single-lever sink mixer with spring spout, and pull-out adjustable led colour handshower. Handshower available in 4 variants: A, B, C and D.

COLOR

OPZIONI COLOR LED LIGHT



La tecnologia COLOR LED LIGHT è disponibile in quattro varianti di performance led:

- A** La luce emanata è solo bianca
- B** Il colore della luce cambia con la temperatura dell'acqua (Azzurro: fino a 32°/Bianco : da 32° a 38°/Rosa: oltre 38°)
- C** Il colore della luce cambia con la temperatura dell'acqua (Blu: fino a 28°, Verde: da 28° a 33°, Giallo: da 33° a 38°, Rosso: da 38°)
- D** 8 colori e sfumature si alternano in un continuo arcobaleno, indipendentemente dalla temperatura.

Le temperature indicate possono variare di circa +/-2 gradi. Per confermare la variante prescelta, aggiungere la lettera corrispondente alla fine del codice prodotto al momento dell'ordine.

COLOR

COLOR LED LIGHT OPTIONS



COLOR LED LIGHT technology is available in four LED performance variants:

- A** The emitted light is white only
- B** The color of the light changes following the water temperature (Light blue: up to 32°, White: from 32° to 38°, Pink: over 38°)
- C** The color of the light changes following the water temperature (Blue: up to 28°, Green: from 28° to 33°, Yellow: from 33° to 38°, Red: from 38°)
- D** 8 colors and shades alternate in a continuous rainbow, regardless of the temperature.

Temperatures may vary by approximately +/- 2 degrees. To confirm the chosen variant, add the corresponding letter at the end of the item code during the purchase phase.



ACQUA DEPURATA - PURIFIED WATER

ACQUA DEPURATA PURIFIED WATER



I miscelatori a 3 vie per acqua depurata permettono di gestire direttamente dal rubinetto della cucina anche l'erogazione dell'acqua proveniente da un depuratore. Due percorsi e due aree di uscita indipendenti preservano la qualità ed il sapore dell'acqua depurata, evitando qualsiasi contatto con l'acqua corrente. L'apertura, la chiusura e la regolazione della temperatura per l'acqua corrente avviene sempre tramite la leva di miscelazione, come nell'uso tradizionale.

The 3-way mixers for purified water allow you to manage the supply of water from a purifier directly from the kitchen tap. Two paths and two independent exit areas preserve the quality and flavor of the purified water, avoiding any contact with running water. The opening, closing and temperature setting for running water are always allowed with the mixing lever, as in traditional use.



TOUCH-ME

COLOR

ACQUA DEPURATA
PURIFIED WATER

MISCELATORE ELETTRONICO PER ACQUA DEPURATA E FRIZZANTE ELECTRONIC MIXER FOR PURIFIED AND SPARKLING WATER

Questo miscelatore per cucina con tastierino elettronico permette di gestire, oltre all'acqua corrente miscelata, fino a 3 diverse selezioni di acqua depurata, ad esempio: acqua depurata, acqua frizzante e acqua refrigerata.

Una leggera pressione di uno dei tre tasti sul pannello attiva ed interrompe l'erogazione dell'acqua desiderata, mentre la leva di miscelazione regola l'acqua corrente secondo la funzionalità tradizionale.

Il prodotto è idoneo alla somministrazione dell'acqua frizzante. Richiede alimentazione a corrente elettrica.

This kitchen mixer with electronic keypad allows you to manage, in addition to mixed running water, up to 3 different selections of purified water, for instance: purified water, sparkling water and cooled water.

A light pressure of one of the three buttons on the panel activates and stops the delivery of the desired water, while the mixing lever set the running water according to traditional functionality.

The product is suitable for the delivery of sparkling water. Requires power supply.

Il miscelatore deve essere collegato ad un apparecchio di depurazione esterno e/o ad un eventuale valvola a 3 ingressi (non inclusi nel prodotto).

NOTA

The mixer must be connected to an external purifier system and / or to a 3-inlet valve (not included in the product).

NOTE



N792TFDW

Miscelatore monocomando a 3+2 vie con tastiera elettronica di selezione per gestire fino a 3 ingressi (ad esempio depurata, frizzante e rinfrescata) e canna girevole. Da collegare agli appositi apparecchi di depurazione, gassificazione e/o filtri. La tastiera elettronica permette di selezionare l'ingresso desiderato per poi attivare ed interrompere l'erogazione corrispondente. La leva di miscelazione regola invece l'acqua calda/fredda non filtrata secondo la funzionalità tradizionale. Alimentazione elettrica sotto lavello.

3+2 ways single-lever mixer with electronic keyboard selection to manage up to 3 inputs (for example purified, sparkling and refreshed) with swivable spout. To be connected to the appropriate purification, gasification devices and/or filters. The electronic keyboard allows to select the desired input and then to activate and to stop the corresponding water delivery. The mixing lever instead regulates the unfiltered hot/cold water according to traditional functionality. Under-sink electric power supply.



N792TFDW

MISCELATORI A TRE VIE PER ACQUA DEPURATA 3 INLETS MIXER FOR PURIFIED WATER

I miscelatori cucina per acqua depurata dispongono di 3 vie di ingresso per gestire da un unico prodotto: (1) acqua corrente calda, (2) acqua corrente fredda e (3) acqua proveniente da un depuratore.

Per attivare l'erogazione dell'acqua depurata è sufficiente ruotare la parte finale della bocca del rubinetto oppure l'apposita leva di deviazione frontale o laterale, a seconda del modello di rubinetteria scelto.

L'apertura, la chiusura e la regolazione della temperatura per l'acqua corrente avviene sempre tramite la leva di miscelazione, come nell'uso tradizionale.

Due percorsi e due aree di uscita indipendenti preservano la qualità ed il sapore dell'acqua depurata, evitando qualsiasi contatto con l'acqua corrente (verificare nelle specifiche del prodotto).

Kitchen mixers for purified water have 3 inlets to manage from a single product: (1) hot running water, (2) cold running water and (3) water from a purifier.

To activate the supply of purified water, simply rotate the end of the tap spout or the appropriate front or side deviation lever, depending on the chosen faucet model.

Two paths and two independent exit areas preserve the quality and flavor of the purified water, avoiding any contact with running water (check the product specifications).

The opening, closing and temperature setting for running water are always allowed with the mixing lever, as in traditional use.

I miscelatori a 3 vie devono essere collegati ad un apparecchio di depurazione esterno (non incluso nel prodotto).

NOTA

The 3-way mixers must be connected to an external purifier system (not included in the product).

NOTE



W79PRDW

Miscelatore monocomando a 3 vie con leva laterale con bocca girevole. È possibile selezionare tra acqua depurata o acqua miscelata tramite la rotazione della parte terminale della bocca di erogazione. Due percorsi di ingresso separati dividono l'acqua miscelata dall'acqua filtrata e portano a due sezioni distinte dell'aeratore.

3 ways single-lever mixer with side lever with swivel spout. It is possible to select between purified water or mixed water by rotating the end part of the spout. Two separate inlets divide the mixed water from the filtered water and lead to two distinct sections of the aerator.



N40DW

Miscelatore lavello Minimale a tre vie di ingresso con bocca girevole, con selezione acqua potabile tramite la leva, con 2 aeratori in uscita.

Three ways inlet minimal single lever sink mixer, with swivel spout, with selection for drinking water directly from the lever, with 2 exit aerators.



Q40DW

Miscelatore lavello Quadrato a tre vie di ingresso con bocca girevole, con selezione acqua potabile tramite la leva, con 2 aeratori in uscita.

Three ways inlet squared single lever sink mixer, with swivel spout, with selection for drinking water directly from the lever, with 2 exit aerators.



W79PRDW

TOUCH-ME

COLOR

ACQUA DEPURATA
PURIFIED WATER



ACQUA CORRENTE MISCELATA
MIXED RUNNING WATER



ACQUA DEPURATA
PURIFIED WATER

Due canali di erogazione
interni differenziati.
*Two separated internal
dispensing paths.*



Bocca girevole.
Swivel spout.

Leva di miscelazione per la
tradizionale gestione dell'acqua
corrente calda e fredda.
*Mixing lever for the traditional
hot and cold running water
management.*

Selettore acqua potabile.
Ruotare di 90° in senso orario
per erogare l'acqua depurata.
*Drinking water selector.
Turn 90° clockwise to
dispense the purified water.*

N792DW



W79DW

Miscelatore lavello serie Winner a 3 vie di ingresso con bocca girevole e 2 vie d'uscita completamente indipendenti, con selezione acqua potabile tramite la leva.
3 ways inlet Winner series single lever sink mixer, with swivel spout and 2 fully independent outlets, with selection for drinking water directly from the lever.



N792DW

Miscelatore lavello serie Minimal a 3 vie di ingresso con bocca girevole e 2 vie d'uscita completamente indipendenti, con selezione acqua potabile tramite la leva.
3 ways inlet minimal series single lever sink mixer, with swivel spout and 2 fully independent outlets, with selection for drinking water directly from the lever.



I79DW

Miscelatore lavello serie Infinity a 3 vie di ingresso con bocca girevole e 2 vie d'uscita completamente indipendenti, con selezione acqua potabile tramite la leva.
3 ways inlet Infinity series single lever sink mixer, with swivel spout and 2 fully independent outlets, with selection for drinking water directly from the lever.



V79DW

Miscelatore lavello serie Vanity a 3 vie di ingresso con bocca girevole e 2 vie d'uscita completamente indipendenti, con selezione acqua potabile tramite la leva.
3 ways inlet Vanity series single lever sink mixer, with swivel spout and 2 fully independent outlets, with selection for drinking water directly from the lever.



D79DW

Miscelatore lavello serie Dream a 3 vie di ingresso con bocca girevole e 2 vie d'uscita completamente indipendenti, con selezione acqua potabile tramite la leva.
3 ways inlet Dream series single lever sink mixer, with swivel spout and 2 fully independent outlets, with selection for drinking water directly from the lever.



L79DW

Miscelatore lavello serie Class Line a 3 vie di ingresso con bocca girevole e 2 vie d'uscita completamente indipendenti, con selezione acqua potabile tramite la leva.
3 ways inlet Class Line series single lever sink mixer, with swivel spout and 2 fully independent outlets, with selection for drinking water directly from the lever.

TOUCH-ME

COLOR

ACQUA DEPURATA
PURIFIED WATER

TECNOLOGIA IN CUCINA - THECNOLOGY IN THE KITCHEN

ELEGANZA IN CUCINA - ELEGANT KITCHEN



ELEGANT GOURMET

pag. 482



GOURMET

pag. 488



ELEGANT KITCHEN

pag. 492



TUTTO CUCINA | *ALL KITCHEN*

pag. 498



CUCINA COUNTRY | *COUNTRY KITCHEN*

pag. 506



BORDO LAVELLO | *DECK SINK MIXER*

pag. 508

ELEGANT GOURMET

ELEGANT GOURMET



I miscelatori monocomando ELEGANT GOURMET portano un dettaglio di stile nelle cucine più spaziose. Il rivestimento della parte superiore in gomma soft-touch dona un effetto estetico elegante e ricercato, oltre a rendere morbido e confortevole il movimento della doccetta. La doccetta può infatti essere estratta dal supporto ed orientata manualmente per direzionare il getto d'acqua e facilitare le operazioni in cucina.

The ELEGANT GOURMET single lever mixers bring a stylish detail to the most spacious kitchens. The soft-touch rubber coating of the upper part gives an elegant and refined aesthetic effect, as well as making the movement of the handheld shower soft and comfortable. The hand shower can be extracted from the support and manually oriented to direct the water jet and facilitate operations in the kitchen.



ELEGANT GOURMET

GOURMET

ELEGANT KITCHEN

TUTTO CUCINA
ALL KITCHENCUCINA COUNTRY
COUNTRY KITCHENBORDO LAVELLO
DECK SINK MIXERS

ELEGANT GOURMET

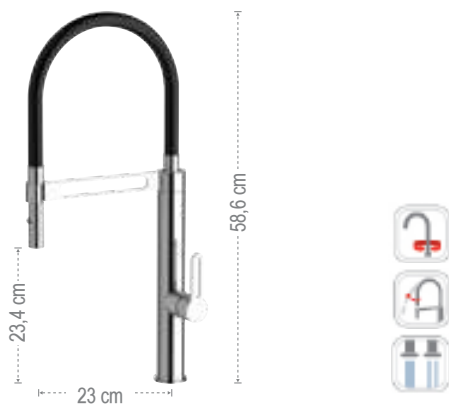

SR511
Miscelatore lavello con flessibile rivestito in tubo gomma soft-touch nero opaco.
Sink mixer with flexible hose coated in soft-touch matt black rubber pipe.



SR512
Miscelatore lavello con flessibile rivestito in tubo gomma soft-touch nero opaco, maniglia verniciata nera opaca.
Sink mixer with flexible hose coated in soft-touch matt black rubber pipe, matt black painted handle.



SR515
Miscelatore lavello con flessibile rivestito in tubo gomma soft-touch bianco opaco.
Sink mixer with flexible hose coated in soft-touch matt white rubber pipe.



SR516
Miscelatore lavello con flessibile rivestito in tubo gomma soft-touch bianco opaco, maniglia verniciata bianca opaca.
Sink mixer with flexible hose coated in soft-touch matt white rubber pipe, matt white painted handle.



SR514
Miscelatore lavello con flessibile bianco rivestito con molla "fine design".
Sink mixer with black flexible hose coated with "fine design" spring.

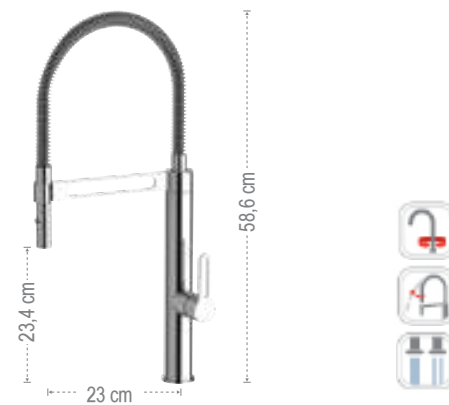

SR513
Miscelatore lavello con flessibile nero rivestito con molla "fine design".
Sink mixer with black flexible hose coated with "fine design" spring.



SR512

ELEGANT GOURMET

GOURMET

ELEGANT KITCHEN

TUTTO CUCINA
ALL KITCHEN

CUCINA COUNTRY
COUNTRY KITCHEN

BORDO LAVELLO
DECK SINK MIXERS



SR541
Miscelatore lavello con flessibile rivestito in tubo gomma soft-touch nero opaco.
Sink mixer with flexible hose coated in soft-touch matt black rubber pipe.



SR542
Miscelatore lavello con flessibile rivestito in tubo gomma soft-touch nero opaco, maniglia verniciata nera opaca.
Sink mixer with flexible hose coated in soft-touch matt black rubber pipe, matt black painted handle.



SR545
Miscelatore lavello con flessibile rivestito in tubo gomma soft-touch bianco opaco.
Sink mixer with flexible hose coated in soft-touch matt white rubber pipe.



SR546
Miscelatore lavello con flessibile rivestito in tubo gomma soft-touch bianco opaco, maniglia verniciata bianca opaca.
Sink mixer with flexible hose coated in soft-touch matt white rubber pipe, matt white painted handle.



SR543

ELEGANT GOURMET

GOURMET

ELEGANT KITCHEN

TUTTO CUCINA
ALL KITCHEN

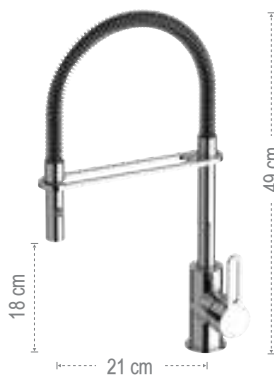

SR543

Miscelatore lavello con flessibile nero rivestito con molla "fine design".
Sink mixer with black flexible hose coated with "fine design" spring.



SR544

Miscelatore lavello con flessibile bianco rivestito con molla "fine design".
Sink mixer with white flexible hose coated with "fine design" spring.

CUCINA COUNTRY
COUNTRY KITCHEN

BORDO LAVELLO
DECK SINK MIXERS

GOURMET

GOURMET



I miscelatori per cucina della linea GOURMET di Remer Rubinetterie, coniugano design ed alta funzionalità. L'alta bocca di erogazione, con molla di tipo classico o fine-design, richiama uno stile professionale ed industriale, particolarmente adatto per cucine con grandi lavelli e banconi ad isola.

The kitchen mixers of the GOURMET line by Remer Rubinetterie combine design and high functionality. The high spout, with a classic or fine-design spring, recalls a professional and industrial style, particularly suitable for kitchens with large sinks and island counters.



EY77E

Miscelatore monocomando lavello a molla con doccetta estraibile dal supporto ed orientabile a due funzioni.

Spring single-lever sink mixer with detachable and adjustable 2-functions handshower.

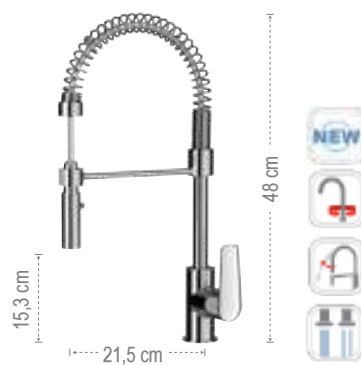

V77E

Miscelatore monocomando lavello serie Vanity a molla con doccetta estraibile dal supporto ed orientabile a due funzioni e cartuccia Ø 35.

Spring single-lever sink mixer Vanity series with detachable and adjustable 2 functions handshower and Ø 35 mm cartridge.

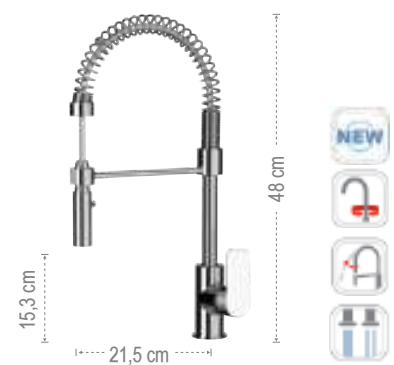

I77E

Miscelatore monocomando lavello serie Infinity a molla con doccetta estraibile dal supporto ed orientabile a due funzioni e cartuccia Ø 35.

Spring single-lever sink mixer Infinity series with detachable and adjustable 2 functions handshower and Ø 35 mm cartridge.



L77E

Miscelatore monocomando lavello serie Class Line a molla con doccetta estraibile dal supporto ed orientabile a due funzioni e cartuccia Ø 35.

Spring single-lever sink mixer Class Line series with detachable and adjustable 2 functions handshower and Ø 35 mm cartridge.

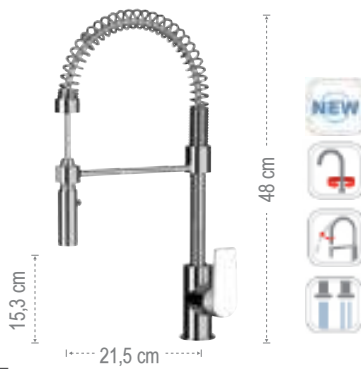

D77E

Miscelatore monocomando lavello serie Dream a molla con doccetta estraibile dal supporto ed orientabile a due funzioni e cartuccia Ø 35.

Spring single-lever sink mixer Dream series with detachable and adjustable 2 functions handshower and Ø 35 mm cartridge.



W77E

Miscelatore monocomando lavello serie Winner a molla con doccetta estraibile dal supporto ed orientabile a due funzioni e cartuccia Ø 35.

Spring single-lever sink mixer Winner series with detachable and adjustable 2 functions handshower and Ø 35 mm cartridge.



N77E

Miscelatore monocomando lavello serie Minimal a molla con doccetta estraibile dal supporto ed orientabile a due funzioni e cartuccia Ø 35.

Spring single-lever sink mixer Minimal series with detachable and adjustable 2 functions handshower and Ø 35 mm cartridge.

ELEGANT GOURMET

GOURMET

ELEGANT KITCHEN

TUTTO CUCINA
ALL KITCHEN

CUCINA COUNTRY
COUNTRY KITCHEN

BORDO LAVELLO
DECK SINK MIXERS



I533

Miscelatore lavello monocomando serie Infinity con flessibile nero rivestito con molla "fine design" girevole 360°, con doccetta estraibile dal supporto ed orientabile a due funzioni e cartuccia Ø 35.

Single-lever mixer Infinity series with black flexible hose coated with "fine design" spring, 360° swivel, with detachable and adjustable 2 functions handshower and Ø 35 mm cartridge.

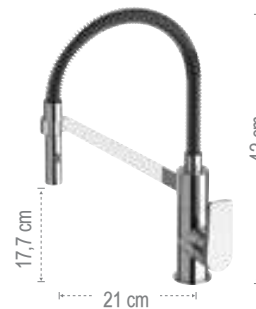

D533

Miscelatore lavello monocomando serie Dream con flessibile nero rivestito con molla "fine design" girevole 360°, con doccetta estraibile dal supporto ed orientabile a due funzioni e cartuccia Ø 35.

Single-lever mixer Dream series with black flexible hose coated with "fine design" spring, 360° swivel, with detachable and adjustable 2 functions handshower and Ø 35 mm cartridge.



L533

Miscelatore lavello monocomando serie Class Line con flessibile nero rivestito con molla "fine design" girevole 360°, con doccetta estraibile dal supporto ed orientabile a due funzioni e cartuccia Ø 35.

Single-lever mixer Class Line series with black flexible hose coated with "fine design" spring, 360° swivel, with detachable and adjustable 2-functions handshower and Ø 35 mm cartridge.

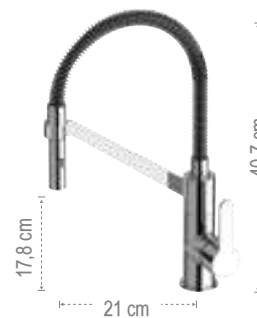

W533

Miscelatore lavello monocomando serie Winner con flessibile nero rivestito con molla "fine design" girevole 360°, con doccetta estraibile dal supporto ed orientabile a due funzioni e cartuccia Ø 35.

Single-lever mixer Winner series with black flexible hose coated with "fine design" spring, 360° swivel, with detachable and adjustable 2 functions handshower and Ø 35 mm cartridge.

ELEGANT GOURMET

GOURMET

ELEGANT KITCHEN

TUTTO CUCINA
ALL KITCHEN

CUCINA COUNTRY
COUNTRY KITCHEN

BORDO LAVELLO
DECK SINK MIXERS



N75E



N75E
Miscelatore monocomando lavello Gourmet, con base tonda e bocca girevole con molla in acciaio inox orientabile.
Single-lever "Gourmet" sink mixer, round body, with swivel spout with orientable spring in stainless steel.



N72E
Miscelatore monocomando lavello con base tonda e bocca girevole a "U."
Single-lever sink mixer, round body, with swivel "U" spout.



N73E
Miscelatore monocomando laterale per lavello a base tonda alto, con bocca a "U" girevole e doccetta dual jet a doppio getto.
Single-lever mixer with round body high "U" movable spout and dual jet shower.

ELEGANT KITCHEN

ELEGANT KITCHEN



Una selezione di miscelatori per lavello dal design moderno e innovativo, studiata per arricchire con personalità ed eleganza la vostra cucina. Tutti gli articoli sono dotati del comfort di una pratica doccetta estraibile.

A selection of sink mixers with a modern and innovative design, designed to enrich your kitchen with elegance and personality. All items are equipped with the comfort of a handy pull-out shower.



ELEGANT GOURMET

GOURMET

ELEGANT KITCHEN

TUTTO CUCINA
ALL KITCHENCUCINA COUNTRY
COUNTRY KITCHENBORDO LAVELLO
DECK SINK MIXERS



V81M

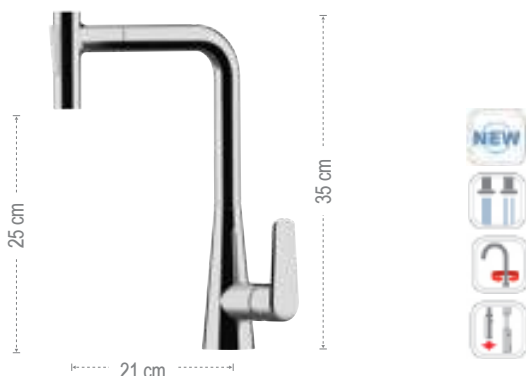

V81M
 Miscelatore monocomando per lavello, con canna alta girevole e doccetta estraibile con impugnatura a martello a due funzioni.
 Single-lever sink mixer with high swivel spout and 2-functions pull-out "hammer shaped" handle hand shower.



L81M
 Miscelatore monocomando per lavello, con canna alta girevole e doccetta estraibile con impugnatura a martello a due funzioni.
 Single-lever sink mixer with high swivel spout and 2-functions pull-out "hammer shaped" handle hand shower.



ELEGANT GOURMET

GOURMET

ELEGANT KITCHEN

TUTTO CUCINA
ALL KITCHEN

CUCINA COUNTRY
COUNTRY KITCHEN

BORDO LAVELLO
DECK SINK MIXERS



V84
Miscelatore monocomando per lavello, con canna alta girevole e sistema di doccetta monofunzione estraibile.
Single-lever sink mixer with high swivel spout and single-function system pull-out hand shower.



V84DJ
Miscelatore monocomando per lavello, con canna alta girevole e doccetta estraibile a due funzioni.
Single-lever sink mixer with high swivel spout and 2-functions pull-out hand shower.





L84



L84
 Miscelatore monocomando per lavello, con canna alta girevole e sistema di doccetta monofunzione estraibile.
 Single-lever sink mixer with high swivel spout and single-function system pull-out hand shower.



EY84
 Miscelatore monocomando per lavello, con canna alta girevole e sistema di doccetta monofunzione estraibile.
 Single-lever sink mixer with high swivel spout and single-function system pull-out hand shower.





ELEGANT GOURMET

GOURMET

ELEGANT KITCHEN

TUTTO CUCINA
ALL KITCHEN

CUCINA COUNTRY
COUNTRY KITCHEN

BORDO LAVELLO
DECK SINK MIXERS



L84DJ

Miscelatore monocomando per lavello, con canna alta girevole e doccetta estraibile a due funzioni.
Single-lever sink mixer with high swivel spout and 2-functions pull-out hand shower.



EY84DJ

Miscelatore monocomando per lavello, con canna alta girevole e doccetta estraibile a due funzioni.
Single-lever sink mixer with high swivel spout and 2-functions pull-out hand shower.

TUTTO CUCINA - ALL KITCHEN

TUTTO CUCINA ALL KITCHEN



Le proposte di miscelatori monocomando e tradizionali per lavello inserite nella sezione TUTTO CUCINA di Remer Rubinetterie giocano sulla varietà di stili e di forme per assicurare la massima praticità di utilizzo e per inserirsi con naturalezza in ogni interno cucina, sia moderno che classico.

The proposals for single-lever and traditional sink mixers included in the ALL KITCHEN section by Remer Rubinetterie play on the variety of styles and shapes to ensure maximum practicality of use and to naturally fit into any kitchen interior, both modern and classic.



ELEGANT GOURMET

GOURMET

ELEGANT KITCHEN

TUTTO CUCINA
ALL KITCHENCUCINA COUNTRY
COUNTRY KITCHENBORDO LAVELLO
DECK SINK MIXERS



V74
Miscelatore monocomando per lavello, con canna alta a C girevole.
Single-lever sink mixer with high swivel "C" spout.



V74U
Miscelatore monocomando per lavello, con canna alta a U girevole.
Single-lever sink mixer with high swivel "U" spout.





ELEGANT GOURMET

GOURMET

ELEGANT KITCHEN

TUTTO CUCINA
ALL KITCHEN

CUCINA COUNTRY
COUNTRY KITCHEN

BORDO LAVELLO
DECK SINK MIXERS



172Q
Miscelatore monocomando per lavello, con bocca alta girevole a "U".
Single lever kitchen mixer with high swivel spout.



Q42U
Miscelatore monocomando per lavello, con bocca alta girevole a "U".
Single lever kitchen mixer with high swivel spout.

TUTTO CUCINA - ALL KITCHEN



W72
Miscelatore monocomando monoforo 90°, con canna alta a "C", girevole e leva laterale.
Single-lever sink mixer 90°, high "C" spout, swivel and side lever.



L72
Miscelatore monocomando monoforo 90°, con canna a "C", girevole e leva laterale.
Single-lever sink mixer 90°, high "C" spout, swivel and side lever.



D72
Miscelatore monocomando monoforo 90°, con canna alta a "C", girevole e leva laterale.
Single-lever sink mixer 90°, high "C" spout, swivel and side lever.



I72
Miscelatore monocomando monoforo 90°, con canna alta a "U", girevole e leva laterale.
Single-lever sink mixer 90°, high "U" spout, swivel and side lever.



W72U
Miscelatore monocomando monoforo 90° con canna alta quadra a "U" girevole e leva laterale.
Single-lever one-hole sink mixer, 90° with high swivel "U" spout and side lever.



L72U
Miscelatore monocomando monoforo 90°, serie Class line con canna alta quadra a "U" girevole e leva laterale.
Single-lever one-hole sink mixer, 90°, Class line series with high swivel "U" spout and side lever.

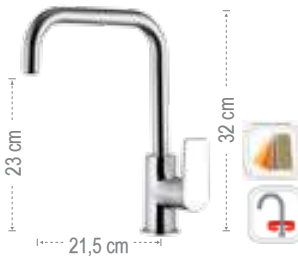

D72U
Miscelatore monocomando monoforo 90°, serie Dream con canna alta quadra a "U" girevole e leva laterale.
Single-lever one-hole sink mixer, 90°, Dream series with high swivel "U" spout and side lever.



U422
Monocomando lavello con bocca alta girevole.
Single lever kitchen mixer with high swivel spout.



L72



L42B

ELEGANT GOURMET

GOURMET

ELEGANT KITCHEN

TUTTO CUCINA
ALL KITCHEN

CUCINA COUNTRY
COUNTRY KITCHEN

BORDO LAVELLO
DECK SINK MIXERS



W42B
Miscelatore monocomando per lavello, con bocca alta girevole.
Single-lever one-hole sink mixer, with high swivel spout.



L42B
Miscelatore monocomando per lavello, con bocca alta girevole.
Single-lever one-hole sink mixer, with high swivel spout.



D42B
Miscelatore monocomando per lavello, con bocca alta girevole.
Single-lever one-hole sink mixer, with high swivel spout.



I42B
Miscelatore monocomando per lavello, con bocca alta girevole.
Single-lever one-hole sink mixer, with high swivel spout.



W42BC
Miscelatore monocomando per lavello, con bocca corta girevole.
Single-lever one-hole sink mixer, with short swivel spout.



L42BC
Miscelatore monocomando per lavello, con bocca corta girevole.
Single-lever one-hole sink mixer, with short swivel spout.



D42BC
Miscelatore monocomando per lavello, con bocca corta girevole.
Single-lever one-hole sink mixer, with short swivel spout.



I42BC
Miscelatore monocomando per lavello, con bocca corta girevole.
Single-lever one-hole sink mixer, with short swivel spout.

DOCCIA ESTRAIBILE - PULL-OUT HAND SHOWER



N85
 Miscelatore monocomando laterale per lavello a base tonda. Alto, con bocca a "C" girevole e doccetta estraibile a due funzioni. Miscelatore e bocca in ottone cromato, doccetta in abs cromato. Canna forma a 180°, girevole, ø mm 35.
Single-lever sink mixer with side lever, round body. High "C" movable spout with pull-out hand shower, two functions. Mixer and spout in c.p. brass, hand shower in cp. abs. Spout shape 180°, swivelling ø mm 35.



N47
 Miscelatore monocomando per lavello con doccetta estraibile.
Single-lever one-hole sink mixer with pull-out hand shower.



K472
 Miscelatore monocomando per lavello con doccetta estraibile a getto variabile 2 funzioni.
Single-lever one-hole sink mixer with pull-out spray 2 functions jet hand shower.



U472
 Monocomando lavello con bocca alta girevole e doccetta estraibile.
Single lever kitchen mixer with high swivel spout, with pull out spray.

INSTALLAZIONE A PARETE - WALL MOUNTED



K412
 Miscelatore monocomando a muro per lavello con bocca girevole.
Wall mounted single-lever sink mixer with swivel spout.



K45
 Miscelatore per lavello a muro con leva lunga.
Wall mounted single-lever sink mixer with long lever.



L41
 Miscelatore monocomando a muro per lavello con bocca girevole.
Wall mounted single-lever sink mixer with swivel spout.



W41
 Miscelatore monocomando a muro per lavello con bocca girevole.
Wall mounted single-lever sink mixer with swivel spout.



BOCCA ALTA - HIGH SPOUT



K422
Miscelatore monocomando per lavello con bocca alta girevole.
Wall mounted single-lever sink mixer with long lever.



R42
Miscelatore monocomando per lavello con bocca alta girevole.
Wall mounted single-lever sink mixer with long lever.



L42
Miscelatore monocomando per lavello con bocca alta girevole.
Wall mounted single-lever sink mixer with long lever.



W42
Miscelatore monocomando per lavello con bocca alta girevole.
Wall mounted single-lever sink mixer with long lever.



BOCCA BASSA - LOW SPOUT



K402
Miscelatore monocomando per lavello con bocca girevole.
Single-lever one-hole sink mixer with swivel spout.



K44
Miscelatore lavello con bocca girevole e con leva lunga.
Sink mixer with swivel spout and long lever.



L40
Miscelatore monocomando per lavello con bocca girevole.
Single lever one-hole sink mixer with swivel spout.



R40
Miscelatore monocomando per lavello con bocca girevole.
Single lever one-hole sink mixer with swivel spout.



SOTTOFINESTRA - UNDER WINDOW



K422R
Miscelatore monocomando monoforo 90° per lavello, con bocca alta girevole ed abbattibile, tipo lusso, modello sottofinestra.
Single-lever one-hole sink mixer, with high swivel and foldable spout, luxury type, under window type.



R42R
Miscelatore monocomando monoforo 90° per lavello, con bocca alta girevole ed abbattibile, tipo lusso, modello sottofinestra.
Single-lever one-hole sink mixer, with high swivel and foldable spout, luxury type, under window type.



L42R
Miscelatore monocomando monoforo 90° per lavello, con bocca alta girevole ed abbattibile, tipo lusso, modello sottofinestra.
Single-lever one-hole sink mixer, with high swivel and foldable spout, luxury type, under window type.



I42R
Miscelatore monocomando monoforo 90° per lavello, con bocca alta girevole ed abbattibile, tipo lusso, modello sottofinestra.
Single-lever one-hole sink mixer, with high swivel and foldable spout, luxury type, under window type.



ELEGANT GOURMET

GOURMET

ELEGANT KITCHEN

TUTTO CUCINA
ALL KITCHEN

CUCINA COUNTRY
COUNTRY KITCHEN

BORDO LAVELLO
DECK SINK MIXERS

CUCINA COUNTRY - COUNTRY KITCHEN

CUCINA COUNTRY COUNTRY KITCHEN



I rubinetti per cucina COUNTRY sono soluzioni bicomando dal design vintage, per tutti gli interni dal marcato stile classico o antico. Disponibili con speciali colori di finitura.

COUNTRY kitchen taps are dual-control solutions with a vintage design, for all interiors with a marked classic or antique style. Available with special finishing colors.



Miscelatore tradizionale bicomando monoforo per lavello con canna antica. One hole dual control sink mixer with "Antique" spout.

ART.

43LIA

43LIACE

VITONE TRADIZIONALE
TRADITIONAL HEAD VALVE

VITONE CERAMICO
CERAMIC HEAD VALVE



Gruppo lavello a muro bicomando con canna superiore antica. Altezza 22 cm, interasse 23 cm. Dual control sink mixer, wall mounted, with swivel high antique spout. Height 22 cm, Interaxis 23 cm.

ART.

41LIA

41LIACE

VITONE TRADIZIONALE
TRADITIONAL HEAD VALVE

VITONE CERAMICO
CERAMIC HEAD VALVE

FIN

FINITURA FINISHING	VITONE TRADIZIONALE TRADITIONAL HEAD VALVE	VITONE CERAMICO CERAMIC HEAD VALVE
 VECCHIO OTTONE - OLD BRASS	VO	CE VO
 OTTONE S. MARCO - S. MARCO BRASS	SM	CE SM
 V. OTTONE OPACO - MATT OLD BRASS	OM	CE OM
 VECCHIO RAME - OLD COPPER	VR	CE VR
 OIL BRONZE - OIL BRONZE	BR	CE BR

BORDO LAVELLO - DECK SINK MIXER

BORDO LAVELLO DECK SINK MIXERS





N48319MO

Miscelatore monocomando bordo lavello serie Minimal con deviatore a leva integrato nella bocca minimale e doccetta estraibile cromata minimale a 4 funzioni con getti in silicone ed anticalcare.

Single lever deck sink mixer serie Minimal ever diverter integrated on the spout, with pull-out C.p. minimal handshower 4 functions, anti-limestone with silicone jets.



N48332EU

Miscelatore monocomando bordo lavello serie Minimal con deviatore a leva integrato nella bocca minimale e doccetta estraibile a pulsante minimale in ABS cromata con impugnatura liscia 1/2".

Single lever deck sink mixer serie Minimal lever diverter integrated on the spout, with pull-out C.p. ABS minimal handshower shut-off, with plain handgrip 1/2".

ELEGANT GOURMET

GOURMET

ELEGANT KITCHEN

TUTTO CUCINA
ALL KITCHEN

CUCINA COUNTRY
COUNTRY KITCHEN

BORDO LAVELLO
DECK SINK MIXERS





ACCESSORI BAGNO
BATH ACCESSORIES



LOUNGE

pag. 514



FLAT

pag. 516



GUEST

pag. 518



MINIMAL INOX

pag. 522



SQ

pag. 524



SUITE

pag. 526



900

pag. 528



EPOCA

pag. 532



ACCESSORI | ACCESSORIES

pag. 534



IDROSCOPINI | HYDRO-BRUSH

pag. 538

LOUNGE



LN13CR



LN13CR
Dispenser per sapone liquido in vetro satinato con supporto in ottone.
Satin glass soap dispenser with cp brass support.



LN15CR
Portabicchiere in ottone con bicchiere in vetro satinato.
Cp brass cup holder with satin glass.



LN10CR
Portasapone in vetro satinato con supporto in ottone.
Satin glass soap dish holder with cp brass support.



LN50CR
Appendino in ottone.
Cp brass hook.



LN44CR
Portasalviette in ottone, 23,6x70 mm.
Cp brass towel holder 23,6x70 mm.



LN60CR
Portarotolo in ottone.
Cp brass toilet paper holder.



LN61CR
Portarotolo di ricambio in ottone.
Brass spare toilet paper holder.

**LN20CR**

Mensola in ottone, dimensione 13x51 cm.
Cp brass shelf, dimensions 13x51 cm.

**LN40CR**

Portasalviette in ottone, lunghezza cm 40.
Cp brass towel holder, length cm 40.

**LN30CR**

Portasalviette in ottone, lunghezza cm 60.
Cp brass towel holder, length cm 60.

**LN33CR**

Portasalviette doppio in ottone, lunghezza cm 60.
Cp brass double towel holder, length cm 60.

RICAMBI - SPARE PARTS

**ACGL10VG**

Portasapone in vetro satinato.
Satin glass soap holder.

**ACGL13LN**

Dispenser in vetro satinato.
Satin glass dispenser.

**ACGL15VG**

Bicchiere in vetro satinato.
Satin glass cup.

FLAT



FT20CR



FT13CR
Dispenser per sapone liquido in ceramica con supporto in ottone.
Ceramic soap dispenser with cp brass support.



FT15CR
Portabicchiere in ottone con bicchiere in ceramica.
Cp brass cup holder with ceramic glass.



FT10CR
Portasapone in ceramica con supporto in ottone.
Ceramic soap dish holder with cp brass support.



FT66CR
Portascopino in ceramica con supporto in ottone.
Ceramic broom rack holder with cp brass support.



FT44CR
Portasalviette ad anello in ottone.
Cp brass towel ring.



FT36CR
Portasciugamano a braccia girevoli in ottone, lunghezza cm 45.
Cp brass multiple bar towel holder with swivelling bars, lenght cm 45.



FT60CR
Portarotolo in ottone.
Cp brass toilet paper holder.



FT61CR
Portarotolo di ricambio in ottone.
Cp brass spare toilet paper holder.



FT50CR
Appendino in ottone.
Cp brass hook.



FT20CR
Mensola in vetro con supporti in ottone, dimensione 12x52 cm.
Glass shelf with cp brass support, dimensions 12x52 cm.



FT40CR
Portasalviette in ottone, lunghezza cm 40.
Cp brass towel holder, lenght cm 40.



FT30CR
Portasalviette in ottone, lunghezza cm 60.
Cp brass towel holder, lenght cm 60.



FT33CR
Portasalviette doppio in ottone, lunghezza cm 60.
Cp brass double towel holder, lenght cm 60.



FTSET8PCR

Set serie FLAT composto da 8 accessori:

- 2 portasapone
- 1 portabicchiere
- 1 portasalviette cm 60
- 1 portasalviette cm 40
- 1 portasalviette ad anello
- 1 appendino
- 1 portarotolo

Set FILAT serie composed of 8 accessories:

- 2 soap dish holders
- 1 cup holder
- 1 towel holder cm 60
- 1 towel holder cm 40
- 1 towel ring
- 1 hook
- 1 toilet paper roll holder

RICAMBI - SPARE PARTS



AC66WI
Scopino da bagno.
Toilet brush.



ACCE10
Portasapone in ceramica.
Ceramic soap holder.



ACCE13WI
Dispenser in ceramica.
Ceramic dispenser.



ACCE15
Bicchiere in ceramica.
Ceramic cup.

GUEST



GS10CR - GS50CR

GUEST

OPZIONI DI FINITURA

Questa collezione di rubinetteria è disponibile con diverse opzioni di finitura, scegli il colore perfetto per il tuo progetto di arredo!

Rispondendo alle esigenze stilistiche dei progetti più ambiziosi, Remer Rubinetterie ha selezionato 7 colori, oltre al cromato, studiati per arricchire, personalizzare e differenziare gli interni di bagno e cucina.

[Per confermare la propria scelta, aggiungere il codice della finitura al termine del codice prodotto durante la fase di acquisto.]

GUEST

FINISHING OPTIONS

This faucet collection is available with different finishing options, choose the perfect color to customize your interior!

Responding to the stylistic needs of the most ambitious designs, Remer Rubinetterie selected 7 colors, in addition to chrome, to enrich, customize and differentiate bathroom and kitchen interiors.

[To confirm your choice, add the finishing code at the end of the item code during the purchase phase.]

CR



cromo
chrome

CR

FIN 1



nero opaco
matt black

NO



bianco opaco
matt white

BO



nichel spazzolato
brushed nickel

NP



nichel spazzolato opaco
matt brushed nickel

NPO

FIN 2



cromo nero spazzolato
brushed black chrome

CFP



oro spazzolato
brushed gold

BG



oro lucido
shiny gold

DO

LOUNGE

FLAT

GUEST

MINIMAL INOX

SQ

SUITE

900

EPOCA

ACCESSORI
ACCESSORIES

IDROSCOPINI
HYDRO-BRUSH



GS13CR
Dispenser per sapone liquido in ceramica con supporto in ottone.
Ceramic soap dispenser with brass support.



GS15CR
Portabicchiere in ottone con bicchiere in ceramica.
Brass cup holder with ceramic glass.



GS60CR
Portarotolo in ottone.
Cp brass toilet paper holder.



GS44CR
Portasalviette ad anello in ottone.
Brass towel ring.



GS10CR
Portasapone in ceramica con supporto in ottone.
Ceramic soap dish holder with brass support.



GS11CR
Portasapone in ottone.
Brass soap holder.



GS62CR
Portarotolo di ricambio in ottone.
Brass spare toilet paper holder.



GS61CR
Portarotolo di ricambio in ottone.
Brass spare toilet paper holder.



GS66CR
Portascopino in ceramica con supporto in ottone.
Ceramic broom rack holder with brass support.



GS50CR
Appendino in ottone.
Brass hook.



GS20CR
Mensola in vetro con supporti in ottone.
Glass shelf with brass support.



GS33CR
Portasalviette doppio in ottone, lunghezza cm 60.
Brass double towel holder, lenght cm 60.



GS30CR
Portasalviette in ottone, lunghezza cm 60.
Brass towel holder, lenght cm 60.



GS40CR
Portasalviette in ottone, lunghezza cm 40.
Brass towel holder, lenght cm 40.



GSSET8PCR
Set serie GUEST composto da 8 accessori:

Set GUEST serie composed of 8 accessories:

- 2 portasapone
- 1 portabicchiere
- 1 portasalviette cm 60
- 1 portasalviette cm 40
- 1 portasalviette ad anello
- 1 appendino
- 1 portarotolo

- 2 soap dish holders
- 1 cup holder
- 1 towel holder cm 60
- 1 towel holder cm 40
- 1 towel ring
- 1 hook
- 1 toilet paper roll holder

RICAMBI - SPARE PARTS



AC66AR
Scopino da bagno.
Toilet brush.



ACCE10
Portasapone in ceramica.
Ceramic soap holder.



ACCE13WI
Dispenser in ceramica.
Ceramic soap dispenser.



ACCE15
Bicchiere in ceramica.
Ceramic glass.



LOUNGE

FLAT

GUEST

MINIMAL INOX

SQ

SUITE

900

EPOCA

ACCESSORI
ACCESSORIES

IDROSCOPINI
HYDRO-BRUSH

MINIMAL INOX



MI15INOXCR - MI50INOXCR



MI13INOXCR
Dispenser per sapone liquido in ceramica con supporto in acciaio INOX.
Ceramic soap dispenser with stainless steel support.



MI15INOXCR
Portabicchiere in acciaio INOX con bicchiere in ceramica.
Stainless steel cup holder with ceramic glass.



MI10INOXCR
Portasapone in ceramica con supporto in acciaio INOX.
Ceramic soap dish holder with stainless steel support.

LOUNGE

FLAT

GUEST

MINIMAL INOX

SU

SUITE

900

EPOCA

ACCESSORI
ACCESSORIES

IDROSCOPINI
HYDRO-BRUSH



MI66INOXCR

Portascopino in ceramica con supporto in acciaio INOX.
Ceramic broom rack holder with stainless steel support.



MI60INOXCR

Portarotolo in acciaio INOX.
Stainless steel toilet paper holder.



MI62INOXCR

Portarotolo di ricambio in acciaio INOX.
Stainless steel spare toilet paper holder.



MI50INOXCR

Appendino in acciaio INOX.
Stainless steel hook.



MI40INOXCR

Portasalviette in acciaio INOX, lunghezza cm 40.
Stainless steel towel holder, length 40.



MI30INOXCR

Portasalviette in acciaio INOX, lunghezza cm 60.
Stainless steel towel holder, length 60.



MI20INOXCR

Mensola in vetro con supporti in acciaio INOX, dimensione 12x53 cm.
Glass shelf with stainless steel support, dimensions 12x53 cm.

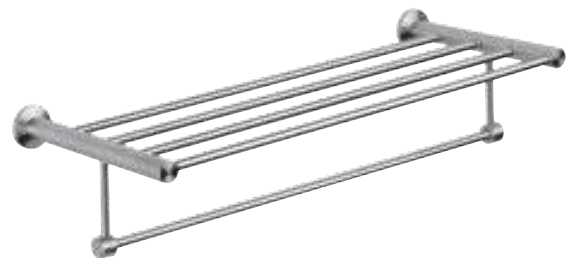

MI70INOXCR

Portasciugamano multiplo in acciaio INOX, lunghezza cm 60.
Stainless steel multiple bar towel holder, length 60.

RICAMBI - SPARE PARTS



AC66MI

Scopino da bagno.
Toilet brush.



ACCE10

Portasapone in ceramica.
Ceramic soap holder.



ACCE13MI

Dispenser in ceramica.
Ceramic soap dispenser.



ACCE15

Bicchiere in ceramica.
Ceramic cup.



SQ13CR - SQ50CR



SQ18CR
Supporto doppio in ottone completo di bicchiere e dispenser in vetro.
Cp brass double holder with glass cup and dispenser.



SQ13CR
Dispenser per sapone liquido in vetro con supporto in ottone.
Glass soap dispenser with cp brass support.



SQ17CR
Supporto doppio in ottone completo di bicchiere e portasapone in vetro.
Cp brass double holder with glass soap dish and cup.



SQ16CR
Portabicchiere doppio in ottone con bicchieri in vetro.
Cp brass double cup support with glass holder.



SQ15CR
Portabicchiere in ottone con bicchiere in vetro.
Cp brass cup holder with glass.



SQ10CR
Portasapone in vetro con supporto in ottone.
Ceramic soap dish holder with cp brass support.



SQ62CR
Portarotolo di ricambio in ottone.
Cp brass spare toilet paper holder.



SQ66CR
Portascopino in ceramica con supporto in ottone.
Ceramic broom rack holder with cp brass support.



SQ60CR
Portarotolo in ottone.
Cp brass toilet paper holder.



SQ44CR
Portasalviette ad anello in ottone.
Cp brass towel ring.



SQ20CR
Mensola in vetro con supporti in ottone, dimensione 10x49 cm.
Glass shelf with cp brass support, dimensions 10x49 cm.



SQ50CR
Appendino in ottone.
Cp brass hook.



SQ33CR
Portasalviette doppio in ottone, lunghezza cm 60.
Cp brass double towel holder, length cm 60.



SQ30CR
Portasalviette in ottone, lunghezza cm 60.
Cp brass towel holder, length cm 60.



SQ40CR
Portasalviette in ottone, lunghezza cm 40.
Cp brass towel holder, length cm 40.



SQSET8PCR
Set serie SQ composto da 8 accessori:

- | | |
|------------------------------|------------------------------|
| - 2 portasapone | - 2 soap dish holders |
| - 1 portabicchiere | - 1 cup holder |
| - 1 portasalviette cm 60 | - 1 towel holder cm 60 |
| - 1 portasalviette cm 40 | - 1 towel holder cm 40 |
| - 1 portasalviette ad anello | - 1 towel ring |
| - 1 appendino | - 1 hook |
| - 1 portarotolo | - 1 toilet paper roll holder |

Set SQ serie composed of 8 accessories:

RICAMBI - SPARE PARTS



AC66AR
Scopino da bagno.
Toilet brush.



ACGL10SU
Portasapone in vetro.
Glass soap holder.



ACGL13
Dispenser in vetro.
Glass soap dispenser.



ACGL15
Bicchiere in vetro.
Glass.

SUITE



SU13CR
 Dispenser per sapone liquido in vetro satinato
 con supporto in ottone.
Satin glass soap dispenser with brass support.



SU15CR
 Portabicchiere in ottone con bicchiere in vetro
 satinato.
Brass cup holder with satin glass.



SU10CR
 Portasapone in vetro satinato con supporto in
 ottone.
Satin glass soap dish holder with brass support.



SU44CR
 Portasalviette ad anello in ottone.
Brass towel ring.



SU60CR
 Portarotolo in ottone.
Brass toilet paper holder.



SU50CR
 Appendino in ottone.
Brass hook.

LOUNGE

FLAT

GUEST

MINIMAL INOX

SQ

SUITE

900

EPOCA

ACCESSORI
ACCESSORIES

IDROSCOPINI
HYDRO-BRUSH



SU62CR
Portarotolo di ricambio in ottone.
Brass spare toilet paper holder.



SU66CR
Portascopino in acciaio INOX.
Stainless steel broom rack holder.



SU40CR
Portasalviette in ottone, lunghezza cm 40.
Brass towel holder, length cm 40.



SU30CR
Portasalviette in ottone, lunghezza cm 60.
Brass towel holder, length cm 60.



SU20CR
Mensola in vetro con supporti in ottone, dimensione 11x49,5 cm.
Glass shelf with brass support, dimensions 11x49,5 cm.



SU33CR
Portasalviette doppio in ottone, lunghezza cm 60.
Brass double towel holder, length cm 60.



SUSET8PCR
Set serie SQ composto da 8 accessori:

- 2 portasapone
- 1 portabicchiere
- 1 portasalviette cm 60
- 1 portasalviette cm 40
- 1 portasalviette ad anello
- 1 appendino
- 1 portarotolo

Set SQ serie composed of 8 accessories:

- 2 soap dish holders
- 1 cup holder
- 1 towel holder cm 60
- 1 towel holder cm 40
- 1 towel ring
- 1 hook
- 1 toilet paper roll holder

RICAMBI - SPARE PARTS



AC66SU
Scopino da bagno.
Toilet brush.



ACGL10SU
Portasapone in vetro satinato.
Satin glass soap holder.



ACGL13
Dispenser in vetro satinato.
Satin glass soap dispenser.



ACGL15
Bicchiere in vetro satinato.
Satin glass.

900



NV10CR

900

OPZIONI DI FINITURA

Questa collezione di rubinetteria è disponibile con diverse opzioni di finitura, scegli il colore perfetto per il tuo progetto di arredo!

Rispondendo alle esigenze stilistiche dei progetti più ambiziosi, Remer Rubinetterie ha selezionato 3 colori, oltre al cromato, studiati per arricchire, personalizzare e differenziare gli interni di bagno e cucina.

[Per confermare la propria scelta, aggiungere il codice della finitura al termine del codice prodotto durante la fase di acquisto.]

900

FINISHING OPTIONS

This faucet collection is available with different finishing options, choose the perfect color to customize your interior!

Responding to the stylistic needs of the most ambitious designs, Remer Rubinetterie selected 3 colors, in addition to chrome, to enrich, customize and differentiate bathroom and kitchen interiors.

[To confirm your choice, add the finishing code at the end of the item code during the purchase phase.]

CR



cromo
chrome

CR

FIN 1



vecchio rame
old copper

VR



vecchio ottone
old brass

VO



nichel spazzolato
brushed nickel

NP



NV13CR

Dispenser per sapone liquido in vetro satinato con supporto in ottone.
satin glass soap dispenser with brass support.



NV15CR

Portabicchiere in ottone con bicchiere in vetro satinato.
Brass cup holder with satin glass.



NV10CR

Portasapone in vetro satinato con supporto in ottone.
Satin glass soap dish holder with brass support.



NV60CR

Portarotolo in ottone.
Brass toilet paper holder.



NV62CR

Portarotolo di ricambio in ottone.
Brass spare toilet paper holder.



NV66CR

Portascopino in ceramica con supporto in ottone.
Ceramic broom rack holder with brass support.



NV44CR

Portasalviette ad anello in ottone.
Brass towel ring.



NV11CR

Portasapone in ottone.
Soap holder in brass.



NV50CR

Appendino in ottone.
Brass hook.



NV20CR

Mensola in vetro con supporti in ottone, dimensione 10x50 cm.
Glass shelf with brass support, dimensions 10x50 cm.



NV40CR

Portasalviette in ottone, lunghezza cm 40.
Brass towel holder, length cm 40.



LOUNGE

FLAT

GUEST

MINIMAL INOX

SQ

SUITE

900

EPOCA

ACCESSORI
ACCESSORIES

IDROSCOPINI
HYDRO-BRUSH

**NV30CR**

Portasalviette in ottone, lunghezza cm 60.
Brass towel holder, length cm 60.

**NV33CR**

Portasalviette doppio in ottone, lunghezza cm 60.
Brass double towel holder, length cm 60.

**NV70CR**

Portasalviette multiplo in ottone, lunghezza cm 60.
Brass multiple bar towel holder, length cm 60.

**NVSET8PCR**

Set serie '900 composto da 8 accessori:
Set '900 serie composed of 8 accessories:



- | | |
|------------------------------|------------------------------|
| - 2 portasapone | - 2 soap dish holders |
| - 1 portabicchiere | - 1 cup holder |
| - 1 portasalviette cm 60 | - 1 towel holder cm 60 |
| - 1 portasalviette cm 40 | - 1 towel holder cm 40 |
| - 1 portasalviette ad anello | - 1 towel ring |
| - 1 appendino | - 1 hook |
| - 1 portarotolo | - 1 toilet paper roll holder |

RICAMBI - SPARE PARTS

**AC66AR**

Scopino da bagno.
Toilet brush.

**ACGL10SU**

Portasapone in vetro satinato.
Satin glass soap holder.

**ACGL13**

Dispenser in vetro satinato.
Satin glass soap dispenser.

**ACGL15**

Bicchiere in vetro satinato.
Satin glass.



NV15CR - NV11CR - NV40CR

LOUNGE

FLAT

GUEST

MINIMAL INOX

SQ

SUITE

900

EPOCA

ACCESSORI
ACCESSORIES

IDROSCOPINI
HYDRO-BRUSH

EPOCA



**IN CERAMICA BIANCA
IN WHITE CERAMIC**

EP10CR



EP13CR
Dispenser per sapone liquido in
ceramica con supporto in ottone.
*Ceramic soap dispenser with brass
support.*



EP15CR
Portabicchiere in ottone con
bicchiere in ceramica.
*Brass cup holder with ceramic
glass.*



EP10CR
Portasapone in ceramica con supporto
in ottone.
*Ceramic soap dish holder with
brass support.*



EP50CR
Appendino in ottone.
Cp brass hook.



EP44CR
Portasalviette ad anello in ottone.
Brass towel ring.



EP60CR
Portarotolo in ottone.
Brass toilet paper holder.



EP62CR
Portarotolo di ricambio in ottone.
Brass spare toilet paper holder.



EP66CR
Portascopino in ceramica con
supporto in ottone.
*Ceramic broom rack holder with
brass support.*

LOUNGE

FLAT

GUEST

MINIMAL INOX

SQ

SUITE

900

EPOCA

ACCESSORI
ACCESSORIES

IDROSCOPINI
HYDRO-BRUSH



EP20CR

Mensola in vetro con supporti in ottone, dimensione 12x52,5 cm.
Glass shelf with brass support, dimensions 12x52,5 cm.



EP40CR

Portasalviette in ottone, lunghezza cm 40.
Brass towel holder, length cm 40.



EP30CR

Portasalviette in ottone, lunghezza cm 60.
Brass towel holder, length cm 60.



EP33CR

Portasalviette doppio in ottone, lunghezza cm 60.
Brass double towel holder, length cm 60.



EPSET8PCR

Set serie SQ composto da 8 accessori:

- 2 portasapone
- 1 portabicchiere
- 1 portasalviette cm 60
- 1 portasalviette cm 40
- 1 portasalviette ad anello
- 1 appendino
- 1 portarotolo

Set SQ serie composed of 8 accessories:

- 2 soap dish holders
- 1 cup holder
- 1 towel holder cm 60
- 1 towel holder cm 40
- 1 towel ring
- 1 hook
- 1 toilet paper roll holder

RICAMBI - SPARE PARTS



AC66AR

Scopino da bagno.
Toilet brush.



ACCE10

Portasapone in ceramica.
Ceramic soap holder.



ACCE13WI

Dispenser in ceramica.
Ceramic soap dispenser.



ACCE15

Bicchiere in ceramica.
Ceramic glass.

ACCESSORI BAGNO BATH ACCESSORIES



RB273CR



RB211CR
Portasapone piccolo rettangolare in ottone.
Dimensioni: 12x9x3 cm.
Brass small rectangular shaped soap holder. Dimensions: 12x9x3 cm.



RB271CR
Portasapone piccolo angolare in ottone.
Dimensioni: 17x11,5x3,2 cm.
Brass small corner soap holder. Dimensions: 17x11,5x3,2 cm.



RB281CR
Portasapone piccolo ovale in ottone.
Dimensioni: 16x10x3,4 cm.
Brass big oval soap holder. Dimensions: 16x10x3,4 cm.



RB273CR
Portasapone angolare in ottone.
Dimensioni: 20,5x17,5x4,5 cm.
Brass corner soap holder. Dimensions: 20,5x17,5x4,5 cm.



RB212CR
Portasapone grande rettangolare in ottone.
Dimensioni: 20,5x11,5x3 cm.
Brass big rectangular shaped soap holder. Dimensions: 20,5x11,5x3 cm.



RB272CR
Portasapone grande angolare in ottone.
Dimensioni: 22x14,3x6 cm.
Brass big corner soap holder. Dimensions: 22x14,3x6 cm.



RB282CR
Portasapone grande ovale in ottone.
Dimensioni: 24,5x11,8x3,4 cm.
Brass small oval soap holder. Dimensions: 24,5x11,8x3,4 cm.



RB277CR
Portasapone doppio angolare in ottone.
Dimensioni: 30,5 x19x19,5 cm.
Brass small corner double soap holder. Dimensions: 30,5 x19x19,5 cm.



RB430CR
Portasalvietta in ottone da cm 60.
Brass towel holder bar, cm 60.



RB440CR
Portasalvietta in ottone da cm 40.
Brass towel holder bar cm 40.



RB310CR
Appendiabito a muro minimale.
Brass minimal hook.



RB312CR
Appendiabiti in linea a due ganci in ottone.
Dimensioni: 20x3 cm.
*Brass clothes holder, two hooks.
Dimensions: 20x3 cm.*



RB313CR
Appendiabiti in linea a tre ganci in ottone.
Dimensioni: 32x3 cm.
*Brass clothes holder, three hooks.
Dimensions: 32x3 cm.*



RB490CR
Sistema filo stendibiancheria i ottone.
Brass clothes line system.



RB495CR
Portasalviette in acciaio INOX.
Dimensioni: 27x14x6 cm.
*Stainless steel tissue holder box.
Dimensions: 27x14x6 cm.*



RB480CR
Maniglione vasca con portasapone in ottone.
Dimensioni: 43x21x13 cm.
*Brass bathtub handle with soap holder.
Dimensions: 43x21x13 cm.*



RB470CR
Portasciugamano multiplo in ottone cm 60.
Brass multiple bar towel holder cm 60.



RB495ACR
Porta kleenex in ABS cromato.
Dimensioni: 25,5x14x6,5 cm.
*Tissue holder box in c.p. Abs.
Dimensions: 25,5x14x6,5 cm.*



RB496CR
Porta sacchetti igienici in Abs.
Dimensioni: 13,5x10x2,5 cm.
*Tissue holder box in c.p. Abs.
Dimensions: 13,5x10x2,5 cm.*



RB711CR
Bilancia elettronica pesapersone pedana in cristallo temperato.
Electronic scale for family use, with footplate in tempered crystal.

LOUNGE

FLAT

GUEST

MINIMAL INOX

SQ

SUITE

900

EPOCA

ACCESSORI
ACCESSORIES

IDROSCOPINI
HYDRO-BRUSH



RB501CR
Portarifiuti, 3 litri, in acciaio INOX.
Altezza 26 cm, Ø 17 cm.
*Toilet bin, 3 liters, in stainless steel.
Height 26 cm, Ø 17 cm.*



RB502CR
Portarifiuti, 5 litri, in acciaio INOX.
Altezza 29 cm, Ø 20 cm.
*Toilet bin, 5 liters, in stainless steel.
Height 29 cm, Ø 20 cm.*



RB503CR
Portarifiuti, 12 litri, in acciaio INOX.
Altezza 39 cm, Ø 25 cm.
*Toilet bin, 12 liters, in stainless steel.
Height 39 cm, Ø 25 cm.*



RB600CR
Dispenser per liquidi in acciaio INOX, capacità
730 ml. Dimensioni: 18,3x10,7x6 cm.
*Dispenser for liquids in stainless steel, capacity
730 ml. Dimensions: 18,3x10,7x6 cm.*



RB605BI
Doppio dispenser per liquidi bianco in ABS.
Dimensioni: 23x13,8x8 cm.
*Double dispenser for liquids all white, in ABS.
Dimensions: 23x13,8x8 cm.*



SE71
Dispenser a sensore per sapone liquido e "liquido
disinfettante". Capacità: 650 ml, batteria: 6 x 1,5 V.
*Sensor dispenser for liquid soap and "liquid
disinfectant". Capacity: 650 ml, battery: 6 x 1,5 V.*



CE



RB465CR
Portascopino sospeso in ottone.
Wall mounted broom rack all in Brass.



RB466CR
Portascopino in acciaio INOX.
Broom rack all in stainless steel.



RB555CR
Piantana porta asciugamani a due posizioni con porta
scopino in ottone, altezza totale 98 cm.
*Cp brass vertical towel holder with 2 arms with
broom rack, height 98 cm.*



RB630CR
Specchio ingranditore a doppia faccia, a muro Ø 15 cm.
Wall mounted magnifier mirror, double side, Ø 15 cm.



RB635CR
Specchio ingranditore a doppia faccia, a muro Ø 21 cm.
Wall mounted magnifier mirror, double side, Ø 21 cm.



RB640CR
Specchio ingranditore a doppia faccia da appoggio Ø 15 cm.
Magnifier mirror, double side, stand version, Ø 15 cm.



AH77LED
Specchio ingranditore retroilluminato, accensione al tocco, spegnimento automatico, a batteria. Ø 18 cm, estensione max 34 cm.
Magnifier backlighted mirror, power touch, automatic shutdown, battery powered. Ø 18 cm, maximum extension 34 cm.



AH77QLED
Specchio ingranditore retroilluminato, accensione al tocco, spegnimento automatico, a batteria. 18x18 cm, estensione max 34 cm.
Magnifier backlighted mirror, power touch, automatic shutdown, battery powered. 18x18 cm, maximum extension 34 cm.



AH75LED
Specchio ingranditore retroilluminato, con spina e interruttore. Ø 21,5 cm, estensione max 26 cm.
Magnifier backlighted mirror, power supply, and switch. Ø 21,5 cm, maximum extension 26 cm.



AH75QLED
Specchio ingranditore retroilluminato, con spina e interruttore. 21x21 cm, estensione max 35 cm.
Magnifier backlighted mirror, power supply, and switch. 21x21 cm, maximum extension 35 cm.

LOUNGE

FLAT

GUEST

MINIMAL INOX

SQ

SUITE

900

EPOCA

ACCESSORI
ACCESSORIES

IDROSCOPINI
HYDRO-BRUSH

IDROSCOPINI HYDRO-BRUSH



RB100S02



RB100

Idroscopino a pulsante "Lux" in ottone, con impugnatura liscia 1/2".
Brass hydro brush "Lux" with plain handgrip, 1/2".



RB120

Idroscopino a pulsante quadrata, serie "SQ", in ottone, 1/2".
Brass hydro brush serie "SQ", with plain handgrip, 1/2"



336L

Rubinetto d'arresto serie Minimal, con supporto doccia in ottone, per flessibile con attacco conico.
Brass minimal angle valve with shower holder, for conical nut flexibles.



336S

Rubinetto d'arresto quadrato, con supporto doccia in ottone, per flessibile con attacco conico.
Brass squared angle valve with shower holder, for conical nut flexibles.

Gli idroscopini e i set con idroscopini sono indicati per la pulizia dei sanitari. Il rubinetto a muro apre e chiude la fornitura di acqua, mentre la doccetta a pulsante permette di gestire l'erogazione durante l'utilizzo.

Hydro-brushes and Hydro-brush sets are suitable for the cleaning of sanitary ware. The wall tap opens and closes the water supply, while the push-button shower allows you to activate the flow during use.

LOUNGE

FLAT

GUEST

MINIMAL INOX

SQ

SUITE

900

EPOCA

ACCESSORI
ACCESSORIES

IDROSCOPINI
HYDRO-BRUSH



RB100S01

Set composto da: idroscopino a pulsante, flessibile con attacco conico cm 120 metallizzato in PVC, rubinetto ad angolo Minimal con vitone ceramico e supporto doccia "Lux" in ottone.
Set composed of: hydro brush handshower, PVC metallized conical flexible hose cm 120, "Minimal" angle valve with ceramic eadwork and "Lux" brass shower holder.



RB100S02

Set composto da: idroscopino a pulsante, flessibile con attacco conico cm 120 in PVC con piattina cromata, rubinetto d'arresto Minimal con vitone ceramico e supporto doccia "Lux" in ottone.
Set composed of: hydro brush handshower, PVC in chrome flat conical flexible hose cm 120, "Minimal" angle valve with ceramic eadwork and "Lux" brass shower holder.



RB100TE

Set composto da: idroscopino a pulsante in ottone, flessibile conico cm 120, rubinetto temporizzato 1/2" in ottone, tempo d'apertura 6-8 secondi.
Set composed of: hydro brush in brass, flexible cm 120, temporized button flusher 1/2" all in brass, opening time 6-8 seconds.

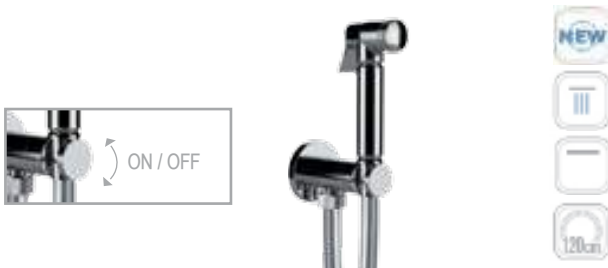

RB140S01

Set composto da: idroscopino a pulsante, flessibile con attacco conico cm 120 metallizzato in PVC, rubinetto ad angolo Minimal con vitone ceramico e supporto doccia "Lux" in ottone, comprensivo di doccetta RB100.
Set including: push-button hydrobrush, 120 cm metallized PVC flexible hose with conical connection, "Minimal" angle tap with ceramic head valve and brass "Lux" shower holder, including hand shower (RB100).



RB160S01

Set composto da: idroscopino a pulsante, flessibile con attacco conico cm 120 metallizzato in PVC, rubinetto ad angolo SQ con vitone ceramico e supporto doccia "Lux" in ottone, comprensivo di doccetta RB120.
Set including: push-button hydrobrush, 120 cm metallized PVC flexible hose with conical connection, SQ corner tap with ceramic head valve and brass "Lux" shower holder, including hand shower (RB120).



RB120S01

Set composto da: idroscopino a pulsante, flessibile con attacco conico cm 120 metallizzato in PVC, rubinetto ad angolo SQ con vitone ceramico e supporto doccia "Lux" in ottone.
Set composed of: hydro brush handshower, PVC metallized conical flexible hose cm 120, "SQ" angle valve with ceramic eadwork and "Lux" brass shower holder.



RB120S02

Set composto da: idroscopino a pulsante, flessibile con attacco conico cm 120 in PVC con piattina cromata, rubinetto d'arresto SQ con vitone ceramico e supporto doccia "Lux" in ottone.
Set composed of: hydro brush handshower, PVC in chrome flat conical flexible hose cm 120, "SQ" angle valve with ceramic eadwork and "Lux" brass shower holder.



ESPOSITORE PER RUBINETTERIA TOUCH - TOUCH MIXERS DISPLAYER



ESPLT 72

Rubinetto con tecnologia Touch-Me da esposizione e dimostrazione.

Utilizzabile in mancanza di possibilità di collegamento del rubinetto Touch alla rete idrica, questa versione DEMO simula esattamente, toccando il miscelatore, l'apertura e chiusura dell'acqua tramite l'accensione e spegnimento di una luce azzurra posizionata in maniera molto visibile nella zona aeratore.

L'articolo è rilavorato per essere esclusivamente dimostrativo.

Faucet with Touch-Me technology for demonstration purpose.

In all the situations where it's not possible to connect the Touch faucet to the water supply, this DEMO version can simulate, when touching the mixer, the exact on/off of the water by turning on/off a blue light positioned in a very visible area by the aerator.

The item is reprocessed for demonstration only.

ESPOSITORE DA PARETE - WALL DISPLAYERS



ESPACVERT



ESPAC

CONDIZIONI GENERALI DI VENDITA

Accettazione ordini

La commissione è sempre subordinata all'approvazione della Casa Venditrice. Le condizioni di vendita si intendono accettate dal committente al momento del conferimento dell'ordine e con il ritiro del materiale.

Consegne e rese

La merce è resa franco deposito di partenza e viaggio a rischio e pericolo del committente. Il venditore si riserva di poter effettuare consegne parziali.

Spedizioni

Le quantità devono essere verificate all'atto del ricevimento ed eventuali discordanze vanno annotate sulla bolla di consegna mediante accettazione "con riserva". Eventuali spese aggiuntive per giacenze sono a carico del committente.

Imballaggio

L'imballaggio è effettuato con imballi standard ed eventualmente su pallets a carico del committente.

Termini di consegna

I termini di consegna, eventualmente indicati, sono sempre forniti a puro titolo indicativo e non vincolante.

Prezzi

I prezzi riportati nei listini non sono vincolanti. La Remer Rubinetterie S.p.A. si riserva la facoltà di variare i prezzi di vendita in qualsiasi momento senza nessun preavviso. Tutti i prezzi indicati nel catalogo sono da intendersi iva esclusa.

Pagamenti

L'eventuale ritardo del pagamento comporterà l'addebito di interessi al tasso corrente. La Remer Rubinetterie S.p.A. si riserva la facoltà di sospendere eventuali ordini in corso in presenza di pagamenti irregolari. Le contestazioni di qualsiasi valore o entità non danno diritto alla sospensione dei pagamenti.

Reclami

Non si accettano reclami o resi merce dopo 7 giorni dal ricevimento della stessa. I reclami devono pervenire entro i termini indicati tramite lettera raccomandata e via fax. Ogni reso deve essere preventivamente autorizzato dalla Remer Rubinetterie S.p.A. che fornirà istruzioni in merito.

Caratteristiche tecniche

La Remer Rubinetterie S.p.A. si riserva la facoltà di apportare ogni variazione agli articoli senza nessun preavviso.

Riservato dominio

I prodotti rimangono di proprietà della Remer Rubinetterie S.p.A. fino al totale pagamento del prezzo in conformità a quanto previsto dal C.C.

Responsabilità

La Remer Rubinetterie S.p.A. non fornisce garanzie circa l'impiego errato o inadatto dei propri prodotti. Qualora il materiale risultasse difettoso per vizi di fabbricazione riconosciuti a seguito di perizia, la Remer Rubinetterie S.p.A. si riserva di sostituirlo o accreditarne il valore senza che la propria responsabilità si possa estendere in nessun caso ad altri oneri.

Foro

Per qualsiasi controversia il Foro competente è quello di Milano.

Stampato nel mese di Maggio 2021

Remer Rubinetterie S.p.A. si riserva il diritto di effettuare modifiche tecniche ed estetiche sui prodotti, senza preavviso alla clientela.

SALE CONDITIONS

Orders acceptance

The order is always subject to approval by the seller.

Delivers

The goods are delivered Ex Works and travel at the buyer's own risk. The seller reserves the right to execute partial consignments.

Forwarding

The quantities must be checked on receipt of the goods and any complaint must be made to the carrier. Any additional cost applied by the carrier will be charged to the buyer.

Packing

The goods are packed in standard packing on pallets charged to the customer.

Delivery terms

The delivery terms are always given as information and they never have to be considered as binding.

Prices

The prices shown on price list are not bending. Remer Rubinetterie S.p.A. reserves the right to modify the sales prices in any time with no prior warning. All the prices indicated in the catalog are to be considered vat excluded.

Payments

Interest at the current rate will be charged for any delays in payment. Remer Rubinetterie S.p.A. reserves the right to delete any order on hand if the payments are not correct. Any complaint of whatever type or value do not give the right to suspend payments.

Complaints

Complaints and returned goods cannot be accepted after a period of 7 days from the arrival of the goods. Complaints must be made by mean of a registered letter or by fax within the terms stated. Any return of the goods must be authorized in advance by Remer Rubinetterie S.p.A. with instructions about it.

Technical specifications

Remer Rubinetterie S.p.A. reserves the right to carry out technical and aesthetical changes without previous notice.

Lien

The products remain the property of Remer Rubinetterie S.p.A. until the cost has been paid in full, in accordance with the provisions of the C.C.

Liability

Remer Rubinetterie S.p.A. does not provide a guarantee covering the incorrect or the inappropriate use of its products. If the material should be substandard owing to manufacturing faults which are technical inspections, Remer Rubinetterie S.p.A. reserves the right to replace the material or to credit the value to the buyer. However under no circumstance does the company's liability extend to the payment of direct or indirect charges for other things.

Competent Court of Law

For any controversy that may arise the competent court of law is the one of Milan.

Printed in May 2021

Remer Rubinetterie S.p.A. reserves the right to introduce technical and aesthetical changes on all the articles, without previous notice to the customer.

REMER
RUBINETTERIE



Ufficio Commerciale Italia:

Tel. 0363 364 333
Fax 0363 63 575

Remer Rubinetterie S.p.A.

Via Leonardo da Vinci, 83
20062 Cassano d'Adda (MI) Italy
Tel. +39 0363 364 211
info@remer.eu www.remer.eu

Export Commercial Department:

Tel. +39 0363 364 364
Fax +39 0363 364 300